

MAKE | BUILD | HACK | CREATE

HackSpace

TECHNOLOGY IN YOUR HANDS

hsmag.cc

December 2021

Issue #49

Compressed air

Add elemental power to your workshop

FreeCAD

Model objects from real life

CODE WITH

LEGO®

Power up your bricks with LEGO® Technic™ Hub or Raspberry Pi

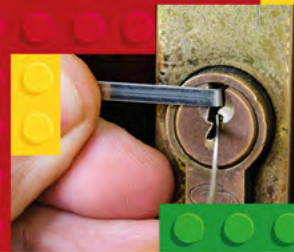

Stereo photography

Explore the magic of 3D images

Dec. 2021
Issue #49 £6



Security

Make your own lock picking tools

GLASS PURE DATA GRAFFITI

American Raspberry Pi Shop

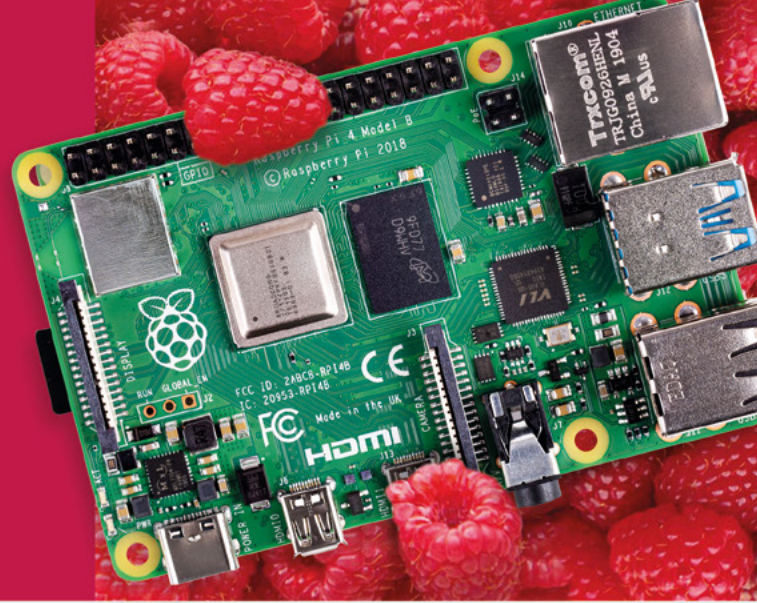

- Displays
- HATs
- Sensors
- Cases
- Arcade
- Swag
- Project Kits
- Cameras
- Power Options
- Add-on Boards
- Cables and Connectors
- GPIO and Prototyping

Partner and official reseller for top Pi brands:



and many
others!

Price, service, design,
and logistics support for
VOLUME PROJECTS

USA



PiShop.us

Canada



PiShop.ca

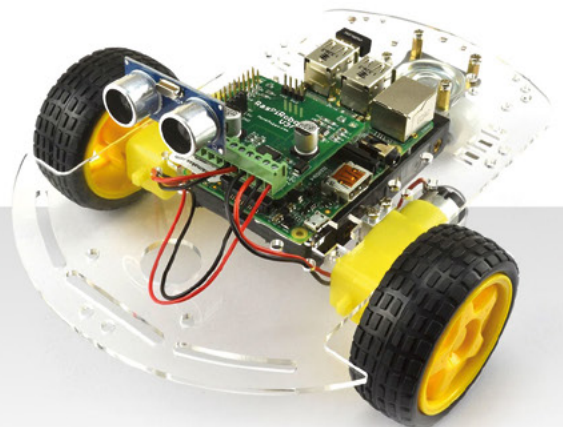

Raspberry Pi

APPROVED RESELLER



Welcome to HackSpace magazine

LEGO®. That word alone is so evocative of builds past. Some elaborate builds of my youth – we kept our assortment of parts and bricks in a wooden box that holds so many great memories. Some more simple builds that I'm doing with my daughter as she learns to express her creativity. If someone had never seen LEGO®, it would be hard to express how important it was to me in my development as a maker. It was flexible enough to give me freedom to build what I wanted, yet was still contained enough to make it easy to connect different parts together. Pirate ships blended with castles and racing cars to create robots, spaceships, and more.

LEGO® has, of course, continued to develop since my parents passed our set on to a family with a younger set of children to enjoy it, but those developments have largely passed me by. At least, they did until a few months ago when we first got the LEGO® Build HAT and assorted LEGO® sets for testing (yes, it's a tough job, but someone has to do it).

Frankly, we've had so much fun hacking different builds together, that it's a bit of a surprise that we managed to create this issue at all. We'll be featuring the fruits of this build-a-thon over the next few months, but turn to page 32 to find out how we got started.

BEN EVERARD

Editor ben.everard@raspberrypi.com

Got a comment, question, or thought about HackSpace magazine?

get in touch at hsmag.cc/hello

GET IN TOUCH

hackspace@raspberrypi.com

[f](#) hackspacemag

[v](#) hackspacemag

ONLINE

hsmag.cc



EDITORIAL

Editor

Ben Everard

ben.everard@raspberrypi.com

Features Editor

Andrew Gregory

andrew.gregory@raspberrypi.com

Sub-Editors

David Higgs, Nicola King

DESIGN

Critical Media

criticalmedia.co.uk

Head of Design

Lee Allen

Designers

Sam Ribbits, Lucy Cowan, Ty Logan

Photography

Brian O'Halloran

CONTRIBUTORS

Mike Bedford, Anton Gutscher, Jo Hinchliffe, Marc de Vinck, Rob Miles, Andrew Lewis, Rosie Hattersley

PUBLISHING

Publishing Director

Russell Barnes

russell@raspberrypi.com

Advertising

Charlie Milligan

charlotte.milligan@raspberrypi.com

DISTRIBUTION

Seymour Distribution Ltd
2 East Poultry Ave,
London EC1A 9PT

+44 (0)207 429 4000

SUBSCRIPTIONS

Unit 6, The Enterprise Centre,
Kelvin Lane, Manor Royal,
Crawley, West Sussex, RH10 9PE

To subscribe

01293 312189

hsmag.cc/subscribe

Subscription queries

hackspace@subscriptionhelpline.co.uk



This magazine is printed on paper sourced from sustainable forests. The printer operates an environmental management system which has been assessed as conforming to ISO 14001.

HackSpace magazine is published by Raspberry Pi (Trading) Ltd., Maurice Wilkes Building, St. John's Innovation Park, Cowley Road, Cambridge, CB4 0DS. The publisher, editor, and contributors accept no responsibility in respect of any omissions or errors relating to goods, products or services referred to or advertised. Except where otherwise noted, content in this magazine is licensed under a Creative Commons Attribution-NonCommercial-ShareAlike 3.0 Unported (CC BY-NC-SA 3.0). ISSN: 2515-5148.

Contents



06

SPARK

- 06 **Top Projects**
Beautiful builds to fire the imagination
- 18 **Objet 3d'art**
Cut glass bottles with 20% PLA
- 20 **Meet the Maker: Anne Barela**
Making CircuitPython accessible for all
- 26 **Letters**
You lot are never satisfied
- 28 **Kickstarting**
Why have one radio when you can have five?

31

LENS

- 32 **Intelligent LEGO®**
Build brains into your bricks with these smart projects
- 44 **How I Made: DIY film scanner**
Digitise family memories with a Raspberry Pi
- 52 **Interview: Sam Topley**
Electronics, soft crafts, and weird synth sounds
- 58 **Improviser's Toolbox** Glass bottles
Turn empty drinks containers into... anything really

94

Cover Feature



LEGO®

Add intelligence to your builds
with LEGO® Technic Hub™ and
Raspberry Pi Build HAT

32

Tutorial

Stereo photography



86

Combine multiple images
for a 3D photographic feel

108





76

Review

Raspberry Pi Zero 2 W

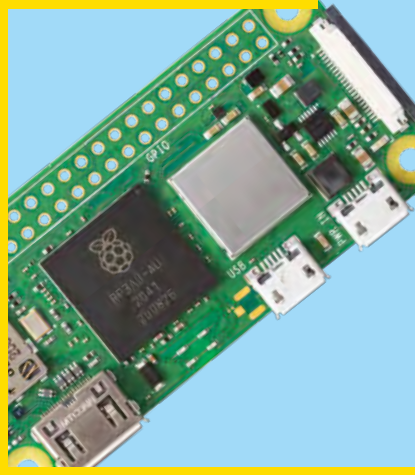

110

Raspberry Pi's even more budget option gets a refresh

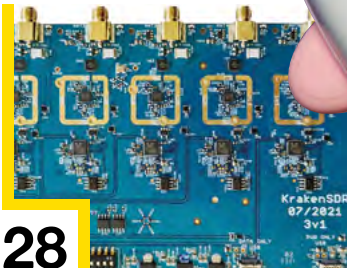

28

Interview

Sam Topley



52

Embroidered circuits, sound, and making with yarn



112



44

63

FORGE

- 64 **SoM Compressors**
Add compressed air power to your workshop
- 70 **Tutorial Lock picking**
Make your own set of lock picking tools
- 76 **Tutorial Make a tablet**
Combine a Raspberry Pi with a touchscreen
- 80 **Tutorial FreeCAD**
Model 3D objects from real life
- 86 **Tutorial Stereo photography**
Make flat images to fool the tiny human mind
- 94 **Tutorial MIDI and Pico**
Combine Pico with Pure Data to make music



102

101

FIELD TEST

- 102 **Best of Breed**
Arduino shields for the olde wired communications
- 108 **Review Radio control unit**
Add remote control over the air waves
- 110 **Review Raspberry Pi Zero 2 W**
The next generation of the budget Linux machine
- 112 **Review Thermal printer**
A cutesy CircuitPython-powered image maker

Some of the tools and techniques shown in HackSpace Magazine are dangerous unless used with skill, experience and appropriate personal protection equipment. While we attempt to guide the reader, ultimately you are responsible for your own safety and understanding the limits of yourself and your equipment. HackSpace Magazine is intended for an adult audience and some projects may be dangerous for children. Raspberry Pi (Trading) Ltd does not accept responsibility for any injuries, damage to equipment, or costs incurred from projects, tutorials or suggestions in HackSpace Magazine. Laws and regulations covering many of the topics in HackSpace Magazine are different between countries, and are always subject to change. You are responsible for understanding the requirements in your jurisdiction and ensuring that you comply with them. Some manufacturers place limits on the use of their hardware which some projects or suggestions in HackSpace Magazine may go beyond. It is your responsibility to understand the manufacturer's limits.

Circuit sculpture

By Edward Agombar

hsmag.cc/CircuitSculpture

Free-form brass soldering is hard. Working in two dimensions is hard enough, but when you add a Z axis, you suddenly need two hands to hold your workpiece plus another two to hold the solder and the iron. And even when you've managed that step, you still have to come up with a working circuit. That's why, just like the brass ring on page 10, we're fascinated by this lamp from Edward Agombar.

It's powered by USB-C and uses four WS2812B LEDs to create a soft glow. There's a Seeeduino XIAO controlling the circuit, and a voltage booster to bring the 3.3V output by the XIAO up to the 5V needed by the LEDs. ▣

Right ▣

There's more going on here than meets the eye, in this programmable Gesamtkunstwerk

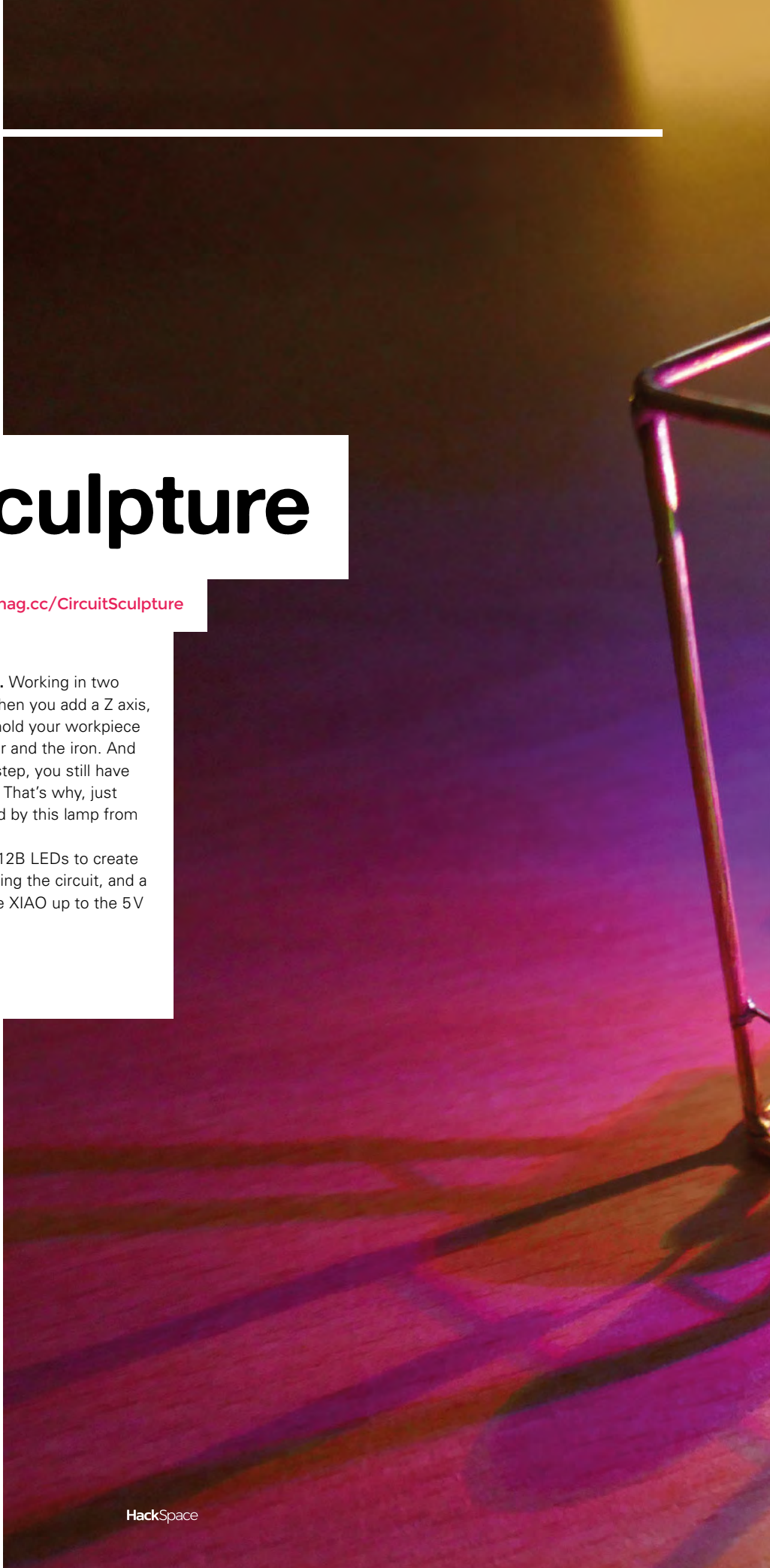

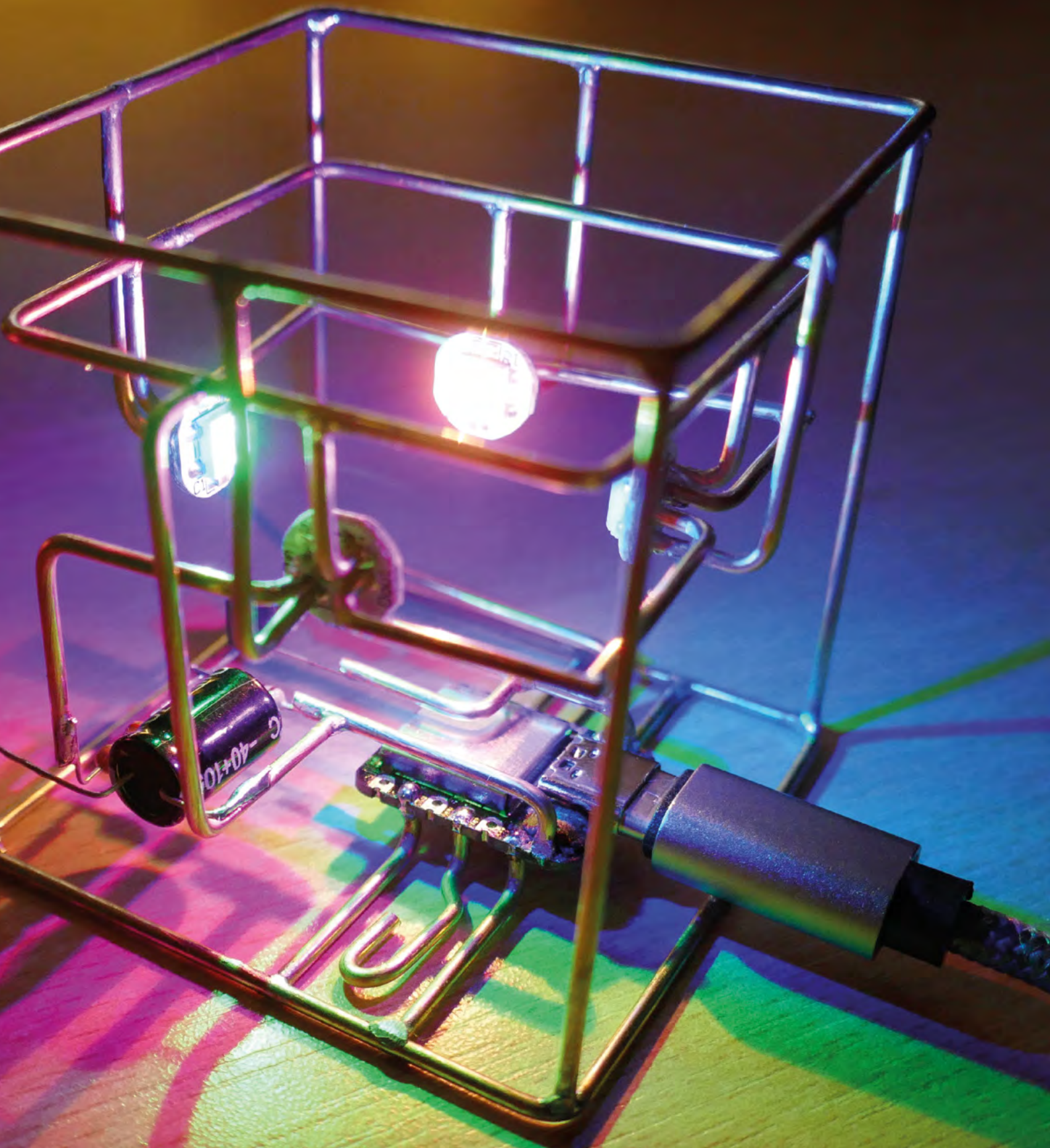

Vintage retro amp

By Mike Wilds

hsmag.cc/MiniAmp

Tinkercad – great for 3D printing, not so much for **woodwork, right?** Wrong! Mike Wilds designed the enclosure for this mini amplifier entirely in this free, online software. On the downside, he had to export it into Fusion 360 to be able to put the sign into the CNC router he had available; on the upside, he's created a video that you can watch and follow step by step if you want to learn how to make smart designs out of wood. Specifically, a few short pieces of mahogany glued together into a block.

The electronics for this project all came out of a kit – purists may grumble, but there's no better way to learn than to follow along with someone else's instructions, knowing that you have all the components that you need. □

Right □

Mike also makes (and teaches others how to make) electric ukuleles. He's a modern-day Leo Fender!



LED ring

By Charlyn Gonda

 charlyn.codes

Free-form brass soldering is hard. The brass cools down too quickly to let you get the solder where you want it, it bends in ways you don't want it to bend, it takes forever to get things that are even functional, let alone aesthetic. That's why this brass ring, with inset LEDs and a hidden battery holder, is so impressive. The most impressive thing is the tiny magnet fixed to the underside of the ring, closest to the wearer's palm, which keeps the battery from slipping out and breaking the circuit – that and the fact that it's perfect. ▣

Right ▣

If you gave us enough time, we could replicate this, but it would look rubbish



Old/new cassette player

By **Matty Makes It**

hsmag.cc/CassettePlayer

Maker **Matty** has taken inspiration from **Instructables** user **Ananords** to mix the now common practice of playing music on solely electronic files with the ancient practice of actually having to pick up a physical object and put it into the machine. What he's ended up with is a device, built into the guts of an old cassette player, that has two buttons: Play/Pause and Shuffle. That, on its own, makes it a useful build for anyone with limited motor control who just wants to listen to a pre-selected range of music, but **Matty's** also added an RFID reader, so the user can select a card with some album artwork and touch it to the device to play a song. **▣**

Right **▣**
For all the nostalgia factor, cassettes were rubbish. Let's upgrade our old players like **Matty** has





SONY CASSETTE RECORDER

EJECT

AUTO STOP SYSTEM







Graffomat

By Niklas Roy

niklasroy.com/graffomat



One of the many, many cool things about Berlin is the quality and quantity of the graffiti art there.

This 2 × 2.2 m plotter build by artist Niklas Roy is the latest addition to that noble tradition. It's controlled by an Arduino Nano, and uses a pair of electric drills to move the plotter head (actually a can of spray paint and an actuator to press the paint nozzle) along the X and Y axes.

Electric drills aren't meant for precision; they have no way of knowing how far they've rotated for, so Niklas had to add black and white encoding strips to each axis, read by an optical sensor, to give positional feedback. So why use electric drills, when the natural choice for something like this would be stepper motors; with built-in encoding you can tell the motor how far to run, thus keeping control over where the spray paint can is. Why do it any other way?

"When I started to build the plotter in spring", Niklas tells us "we were still in a lockdown. So I wanted to use mainly materials that I had in the cellar. Since I had one cordless drill with a broken battery, I thought that this would be a good choice to drive the plotter. My janitor had a similar cordless drill, also with a broken battery, which he donated for the project. At the end, cordless drills are very powerful DC gearmotors. They are easy to drive and it's very simple to mechanically attach a pulley or a rod to their chuck." →

Left

If you want to see the Graffomat in action, head to Stadtpark Lichtenberg, Berlin. You might see it, you might not, but at least you'll be in a nice place in a lovely city

“In my opinion, stepper motors are also quite annoying to use. The faster you spin them, the less torque they have. Of course, there are stepper motors which are powerful enough for such a project – but they would be really expensive, and I wanted to build this machine really cheap. (The whole machine just cost me about 200 euros.)”

Niklas chose the name Graffomat partly in tribute to fellow Berliner Konrad Zuse, whose company developed one of the first pen plotters – the Graphomat Z64. “It turned out that my new buddies at the [graffiti wall] confused Zuse with former East German party leader Erich Honecker. They advised me to write Zuse’s name below his picture for clarification.” Kids today!

As this is a plotter, you don’t have to be in the same room to use it; it’s perfectly happy working on coordinates supplied over the internet. But what do the local graffiti artists think to Niklas’s creation? “The artists who are active on those walls basically spend a lot of money on spray paint which they throw at the wall and the next day (or couple of hours later), someone else comes and paints over their work. No one will become unemployed because of my machine. And let’s be honest, the machine is not even very good at painting graffiti. The artists who operate the cans manually have much better nozzle control. I think it would take something like a 5-axis CNC, with a camera mounted close to the nozzle for a visual feedback loop, in order to come close to what the graffiti artists are able to spray. Therefore, the machine is rather seen as a curiosity at the walls.” □

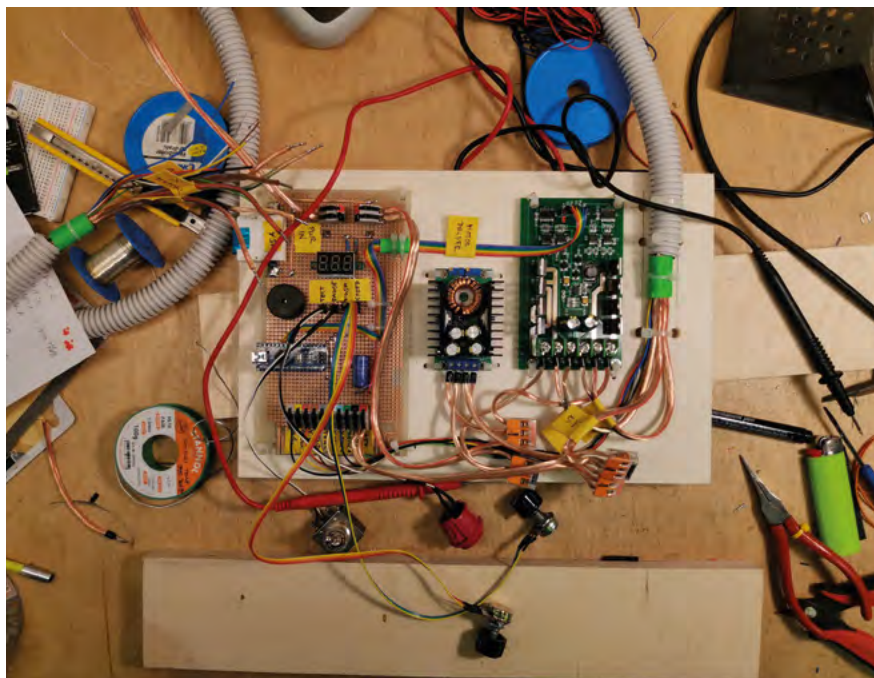

Right □
One bonus reason for using electric drills rather than stepper motors is that Niklas found it funny. Fair enough!

Images
Niklas Roy, CC BY 3.0
creativecommons.org/licenses/by/3.0



Objet 3d'art

3D-printed artwork to bring more beauty into your life

C

hristmas is coming, and if you're anything like us, you might end up with a glass bottle or two to get rid of once the festive carnage

abates. Rather than chuck them all out, you'll find that glass bottles contain heaps of potential for chandeliers, ashtrays, drinking vessels, and more.

That's why we like this glass cutting tool, designed and built by Nick. Like a lot of functional 3D prints, it uses metal parts for adjustability: there are captive nuts, a couple of threaded rods to cater for different sized bottles, and there's also the blade itself.

If you want to make one of these, be prepared for a lengthy print time: it has to be strong and accurate to produce precise cuts, so you're looking at a print time of 23 hours.

If you want to be inspired with some projects that you can do with a tool like this, turn to page 58 for a load of ideas. ▣

hsmag.cc/GlassCutter



Meet The Maker: Anne Barela

On ease of use and getting back to your roots



If you've ever programmed anything in CircuitPython and understood the instructions first time, you probably have Anne Barela to thank. She's a consulting engineer at Adafruit, where she puts her vast array of experience into helping people make cool stuff that 'just works'. She's had her work go into space on the Shuttle, she helped make sure the world's computers didn't melt when the clocks reset to zero in the year 2000, and she's a big fan of open source. We got a bit flustered when we spoke to her to be honest – where do you start with a career that's included Caltech, Hewlett-Packard, NASA, Boeing,

"I publish the 'Python on microcontrollers' newsletter. That's probably the largest newsletter catering to Python on hardware, with just over 9000 subscribers. I need to be intimately involved in the communities, so I can gather all the news and information and happenings in the area, so I'm rather busy trying to find out who's using CircuitPython, MicroPython, Python on Raspberry Pi. And hopefully, if they're using sensors and bits and bobs, they may consider using the Blinka compatibility library which led to the use of CircuitPython code on single-board computers.

"It was around 2013. I was rekindling my hardware interests back from university, having had a career in diplomacy. I'd been tinkering with IBM PCs since the dawn of time, and I was kind of daunted that an Arduino Uno, at the time, was about \$35. And Adafruit came out with the small Trinket board, which was mostly compatible at about \$10.

"And so I started playing with it – it had some particular issues being a smaller chip. And I started to program that and that kind of got Adafruit's notice. They asked me to write tutorials on what I'd done, and the projects I'd done. So I did that, and wrote several different things. And then Make magazine said they wanted to do a book on the Trinket.

"But I was writing tutorials, ad hoc, for about five years. And my career with the State Department was winding up after about 30 years. Limor Fried and Phil

" I'd been tinkering with IBM PCs since the dawn of time, and I was kind of daunted that an Arduino Uno, at the time, was about \$35

and the US Diplomatic Service? So, we started with something we can all understand: CircuitPython.

"I'm on the CircuitPython team, I assist them. I don't do a lot of the direct programming on the core – that's led by Scott Shawcroft. I am more the documentation person.



Left ♦ Low-power e-ink screens can display information without swallowing battery life

Below ♦ Electronic name badges are a staple of hacker meetups

Torrone invited me to New York, where we toured the town and, over dinner, asked if I wanted to join the company full-time as an engineering consultant. After a little bit of thought, I said yes.

ON A HIGHER LEVEL

“Python is becoming more and more the default language that things are programmed in. I mean, Raspberry Pi chose Python as their preferred language several years ago, back in the early days, and that was likely an excellent decision because universities, and now schools, are teaching Python.

“It’s a very easy-to-understand, very structured language. There aren’t a lot of details in there that you have to remember, such as curly braces or, you know, lots of parenthesis like the Lisp language. And so CircuitPython is kind of riding the wave of Python in general. →



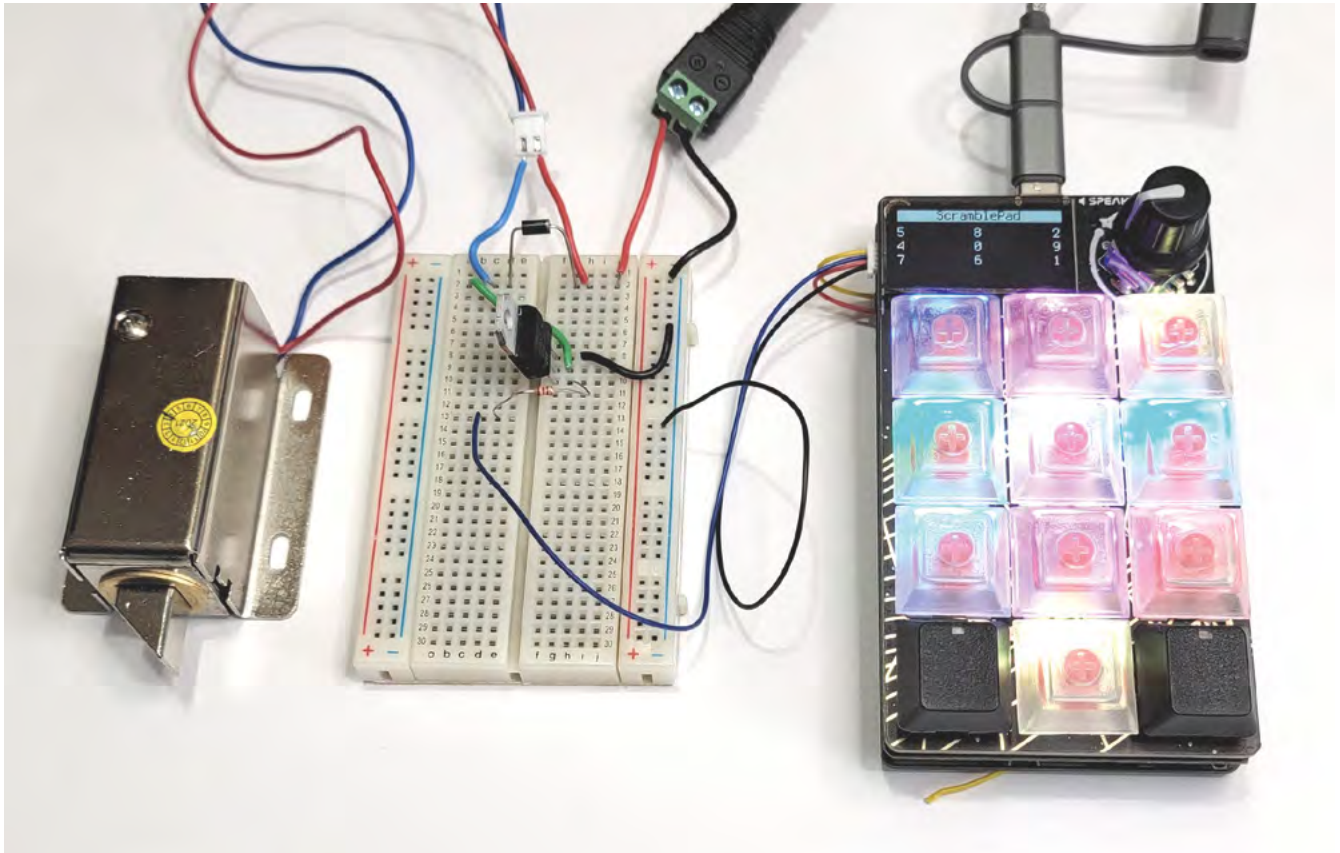

“Some people think that Adafruit just took MicroPython and went in a wholly different direction – that’s not true: with version seven, we’ve incorporated all the changes that have happened to MicroPython, into CircuitPython, so they’re equal. But, of course, there are differences. And that involves some of the philosophy that Adafruit is looking to embody in open source. They would like it to be much easier to use for beginners.

“The typical thing [when coding for dev boards] is that you have a development environment within one’s PC, or Mac, you complete the code, and then have to download some binary file via some mechanism to the board. And if something’s wrong, you have to go through the entire process again: fixing the code, compiling it, and loading it to the board.

“They made a decision early on that CircuitPython boards will look to a host computer as a flash drive. And so, all you need to put code on the board is edit it in any text editor you like, then copy that text file

over to the board and the code immediately runs. If you have a problem, you just edit the code and copy it – there’s no compilation step or anything. So it’s a very fast, efficient, intuitive development cycle.

“And, finally, they’ve been building on things that they perceive as really pertinent to the maker industry. Right now, that would be keyboards – people are building their own keyboards, or macro

pads, or whatever, to augment all kinds of things. And so they put a lot of effort into the USB technology and CircuitPython, specifically HID, so that it’s virtually child’s play to set up any device (say the Pico for example) as an HID keyboard, and

then you connect your keys to the I/O pins.

“That’s one thing Adafruit and I really synergize with; you don’t want to have to focus deep-down on the technology in order to get basic things to work. It starts to fry the brain of a creative person or a beginner. So, you want to try to flatten that learning curve as much as possible. And I think CircuitPython accomplishes that quite well. So the people actually

// You don’t want to have to focus deep-down on the technology in order to get basic things to work

//

Above ♦ You only need one or two I/O pins to control lots of hardware, such as this lock

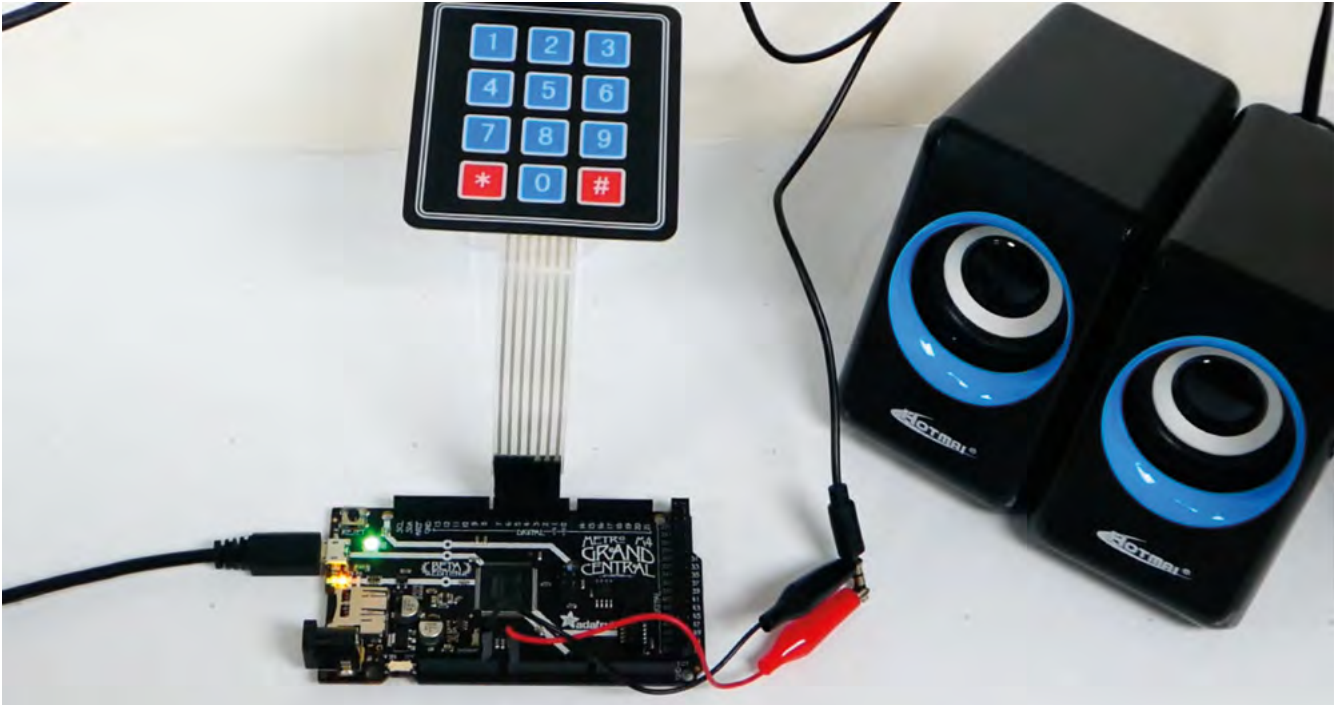

building the project, you know, a Halloween costume or something blinky for the holidays, or whatever – they’re not struggling with technology, they’re saying, ‘OK, I got it to blink’. That’s the creative part of it.

“Some of those creative people are up to the programming challenge, but they would get a lot less done if they had to really struggle with other types of builds. I mean, Arduino started to provide creative people with access to the technology, and they were wildly successful. But these days, we want more creatives. And the Arduino environment isn’t providing that. I think CircuitPython does in its ease of use, and the strengths that are actually built into it.

INFORMATION FOR EVERYONE

“Open source, to me, is everything. I realised back at the State Department that there was no institutional knowledge being pooled. Like Wikipedia. I mean, I was involved a bit in Wikipedia and, that was wonderful that we’re all pooling the knowledge together. They started a pilot programme called Diplopedia, to share diplomatic knowledge. But they really weren’t putting any effort into it. So in my spare time, I contributed a lot to that programme – all the information I’d known about, I’d gathered from other places, hyperlink it all, and it kind of took off more than it might have if it was a kind of a bureaucratic effort.

“So, with that in mind, if it was me blogging, or me writing an Adafruit tutorial, or writing a book, or any of those types of things, it became: if I’ve got knowledge, and it will help others, why not share it? I’m not looking to patent any of my projects. So if I leave this planet, having contributed to a bigger whole, I would feel good about that, I think.

“I don’t think Adafruit would maybe thrive quite as much if they were a monopoly, versus having [competition from] SparkFun and Pimoroni, and a number of other maker companies in the environment. I mean, the best ideas come out →

Above ♦ Membrane keypads are cheap ways of adding a lot of buttons

Below ♦ The NeoTrellis is a great choice for audio projects



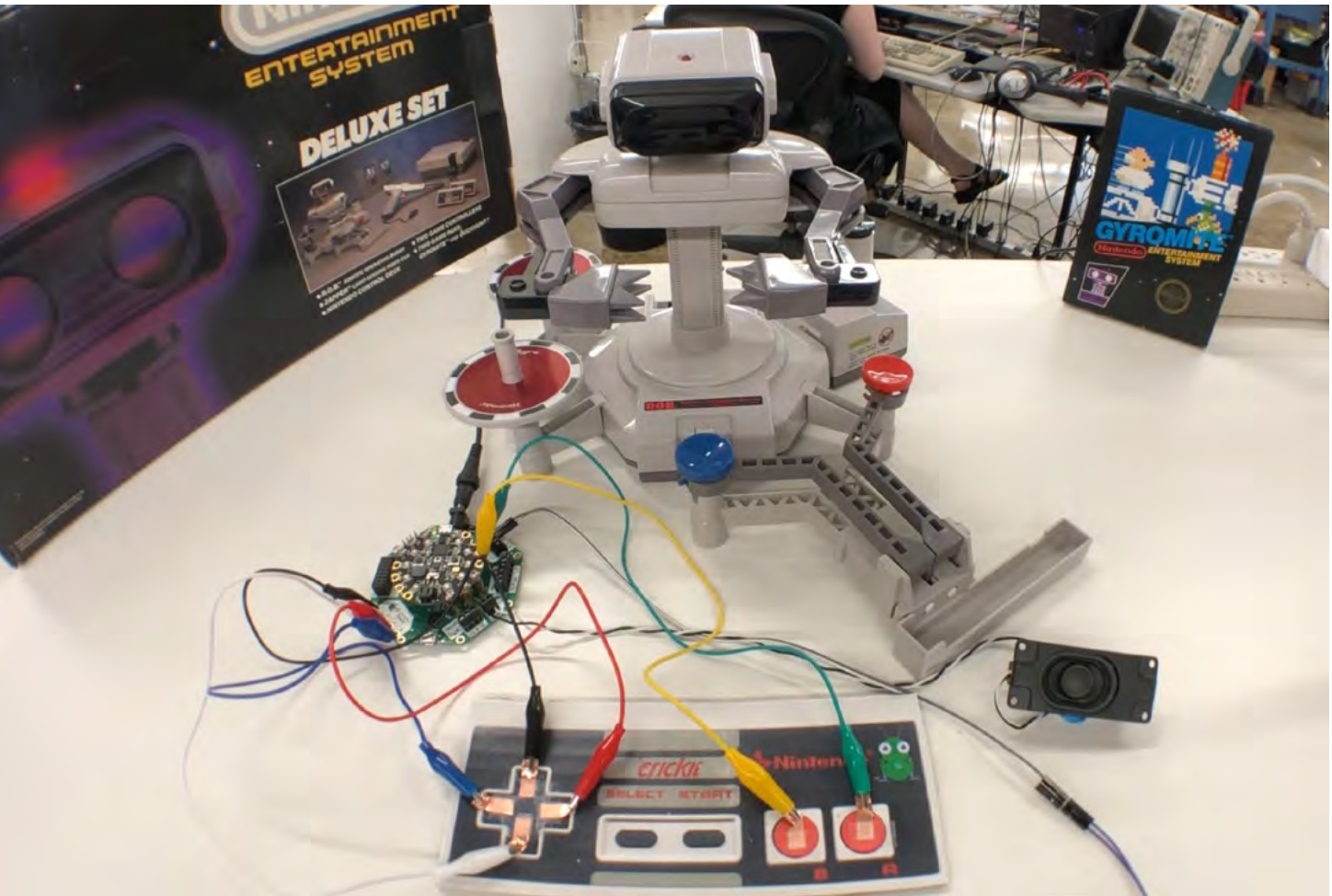

amongst the various people in the space, and the best ones kind of survived to go on.

“Take the space sector right now. People should be open-minded to the fact that Jeff Bezos might have ideas that come to fruition that maybe Elon Musk hasn’t quite thought of or funded. Obviously, Musk has a lead in a lot of this. I see a lot of SpaceX Falcon 9 launches from Kennedy Space Center – I can watch them take off from the end of the road, and it’s wonderful. So I would hope that all that technology is burning more ideas and proving the good ideas to help everybody rather than saying, ‘Well, why do we have all of these different ones?’ Let’s just go with the more proven ones, especially with the government.

“I mean, Ariane and the Artemis programme from NASA, there’s some good technology already

established. And those can be leveraged. I mean, in electrical engineering, you don’t throw out a 100-year-old idea just because it wasn’t thought of in the last 20 years; people often go back and say, ‘That’s exactly what I need’.

And I think that can happen in the space programme too.

[At university] I jumped into the electrical engineering classes, specialising in digital circuits, and microprocessors at the time, but also switching power supplies. There was a professor at the

university who invented a different kind of switching power supply that was kind of in-between a buck and a boost. So I mean, he was teaching us all the intricacies of switching mode power supplies back when it really wasn’t used all that much. And now they’re everywhere. So, I was programming a wide variety of microprocessors, and building my own

You don’t throw out a 100-year-old idea just because it wasn’t thought of in the last 20 years

Above ♦ Microcontrollers can be used to control all sorts of hardware

systems. And that led to being noticed by an upperclassman, who said, 'Well, we have this position as an intern at JPL [Caltech's Jet Propulsion Laboratory].'

SPYING ON THE SILK ROAD

"So I was recruited. I worked on microprocessor systems for a programme that was building synthetic aperture radars, at the time flying on aircraft. Those radars were able to penetrate foliage and sand, and they were finding things in jungles and deserts that had never been found before. They were finding the ancient trade routes between China and the biblical areas because they're hidden in the sand. I mean, they were trodden for 1000 years, but you can't see them now because the sand's there, but the radar could penetrate through and see those routes. That technology later was perfected for the Space Shuttle, and there was at least one Shuttle mission where they flew and mapped various parts of the Earth with a synthetic aperture radar.

"JPL offered me a full-time job upon graduating. And it would have probably been a really good career – I have friends who stayed at JPL, and they've managed programmes and some of the more famous missions, but I was looking to get out of Southern California, and my opportunity was being recruited by Boeing. The work they put me on was working on the Ronald Reagan Star Wars programme. When they did simulations in my group – which were right out of the movie *WarGames* – they would simulate firing missiles at Russia from submarines, and missiles being fired back, to see who might annihilate who.

"There's some interesting things about working in defence, but I didn't find it the right fit for me, and my electronics knowledge was starting to taper away and I didn't like that. But a colleague in the group, I think he was a former government employee, he brought in a newspaper clipping that said, 'see the world, you don't have to kill anybody'.

"And so I applied, took some tests and a physical, and eventually I moved cross-country to Washington, DC and had a lot of training. And then they shipped me to New Delhi, India. But it was interesting in that I was using my engineering skills to protect people in embassies – over the years, embassies became very big targets. There were attacks on Nairobi and Dar es Salaam against the American embassies in the late 1990s. And there were lesser-known attacks using technical systems, as opposed to bullets and thick walls and stuff; the diplomats there hate thick walls and barbed wire, because that doesn't look like this inviting thing of exchanging ideas.

"We rode that thin line of making embassies accessible but still secure. We introduced explosive detectors and X-rays, kind of like an airport, and they did find some things, bad things people were looking to bring in. Again, it's kind of leveraging some of the ideas of others. And that would be all of the aviation security people to keep embassies and consulates secure. So it kind of fits into that same mould of not reinventing the wheel.

"Eventually I managed various groups who did fun things. [Anne played a part in getting the new US embassy in London built.] Then, as my career was winding up, thought I'd better think of a hobby that I really like. And there it was: electronics!" □

Below ♦
Books: an old idea for sharing knowledge that's still relevant today



Letters

ATTENTION ALL MAKERS!

If you have something you'd like to get off your chest (or even throw a word of praise in our direction), let us know at hsmag.cc/hello

PICO PLEASE

A request: please let's have more Pico stuff. When I first got my hands on one of these little boards (which I found on the cover of HackSpace magazine, no less), there weren't any projects about that I could copy. Obvious, really, given that it was new. But I thought, fine; there will be some more along in a minute. So give us more! My Pico is sitting in my desk drawer and I feel guilty for not doing more stuff with it!

Dave Chappell
Pennsylvania

Ben says: Well, last issue's How I Made featured a Pico being used to display automotive data in a car. And then there was the keyboard, also in the last issue, which used a Pico to map buttons to notes. Next issue, we've got a lathe that was damaged beyond repair, only for a humble Pico to come and save the day. And this issue... well, you're reading this issue, so you'll find out soon enough. But I do think you're right: it's past time for us to round up a load of Pico ideas in one place, to find out what people have been doing with them out in the wide world, and to inspire us all to make something new. We're on the case!

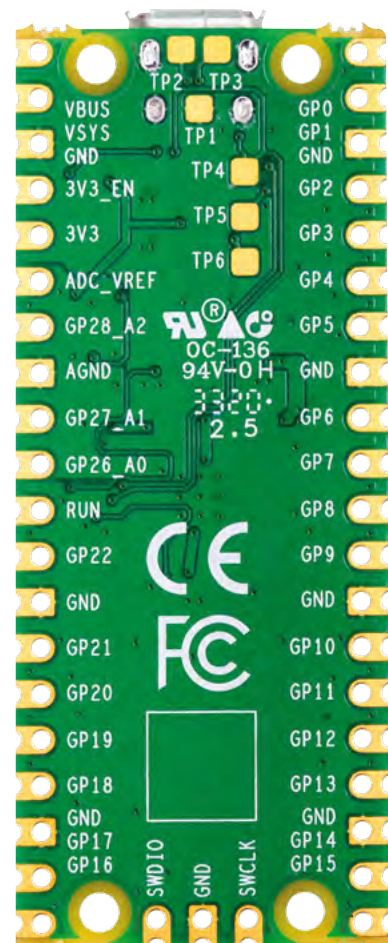
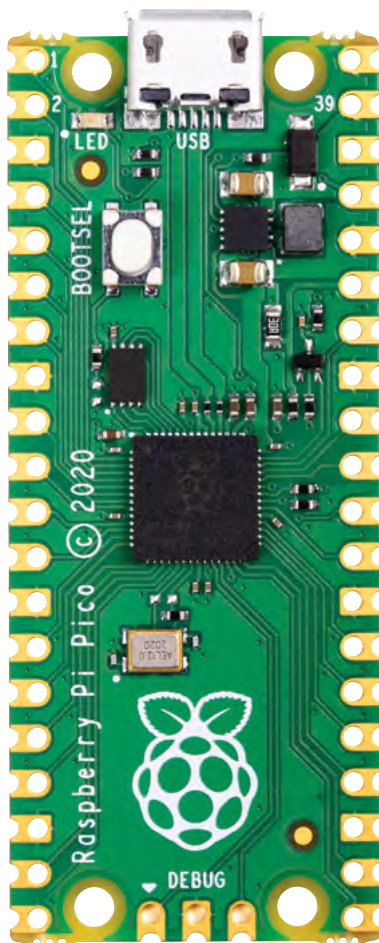



LOCK PICKING

There was an introduction to lock picking in the last issue... why would I need to know how to break in somewhere without a key? It's bad enough that people associate 'hacking' with crime, but showing actually how to break into people's homes is just fuel for the fire. What were you thinking?

Brian King

Bradford

Ben says: As our writer says in part 1 (you can read part 2 on page 72), the golden rule of lock picking, is "never pick a lock that you don't own". And the interest in lock picking (at least, what we find interesting about it) is simply the desire to find out how things work. It's like cracking a code, working out how the pieces fit together, and then turning the lock with a satisfying 'snick' of metal on metal. You have to be patient, and not try too hard – it's quite a relaxing process. The meditative nature of lock picking would be severely diminished by flashing blue lights and the presence of Her Majesty's Constabulary.

VALVES

I read with interest your simple circuit build using a vacuum tube – now, can we have some more please? I've always loved the way the valves in my guitar amp glow for a couple of seconds after I've switched it off – it's as if there's magic in there. There might as well be for all I understand it, or at least until I read the last issue.

Simon Brown

London

Ben says: In many ways valves are rubbish; they break, they're massive, they're expensive, and they run at high voltages, which make them a lot less forgiving than transistors. The chip in my smartphone has 3 billion transistors – that's just the processor, not the RAM or the storage. An equivalent chip with 3 billion valves just wouldn't be possible – there isn't room in my pocket for that much valve-based power. However, valves look cool, and that's very important. All we can promise is that we'll try to get some valve-based projects – and if anyone reading this has made something interesting with vacuum tubes, let us know!



CROWDFUNDING NOW

KrakenSDR

For when one radio just isn't enough

From \$299 | crowdsupply.com | Delivery: March 2022

Software-defined radio (SDR) is where much of the processing of a radio signal is done in software rather than (as is more traditional) hardware. The result is a very flexible system that makes it possible to use the same receiving hardware to do a number of different tasks. Some of the most popular SDR systems have been digital TV dongles, which are cheap and offer quite a flexible interface. However, these are fundamentally designed for receiving TV, and not for the needs of radio enthusiasts and makers.

Enter KrakenSDR. This packs five radio receivers into a single package. The advantage of having more than one is that it lets you compare the signals received at different points. This can be used for features like direction-finding, passive radar, and beamforming.

Obviously, as well as the radio hardware, you'll need some computational hardware to do the software-defined part of this. Kraken recommend a

Raspberry Pi 4, and will provide an SD card image with the relevant software already installed. This includes a web interface so you can access the hardware remotely, and there's also an Android app that you can use on the go.

//

This gives you the hardware you need.

You just need to worry about the software

//

KrakenSDR is a base for you to build on. Whether you're trying to locate beacons (such as wildlife tags), identify sources of interference, or just need five separate radio receivers, this gives you the hardware you need. You just need to worry about the software. □

BUYER BEWARE

When backing a crowdfunding campaign, you are not purchasing a finished product, but supporting a project working on something new. There is a very real chance that the product will never ship and you'll lose your money. It's a great way to support projects you like and get some cheap hardware in the process, but if you use it purely as a chance to snag cheap stuff, you may find that you get burned.



Left  A set of five compatible antennae is an optional add-on

Below  KrakenSDR is, confusingly, the hardware part of software radio

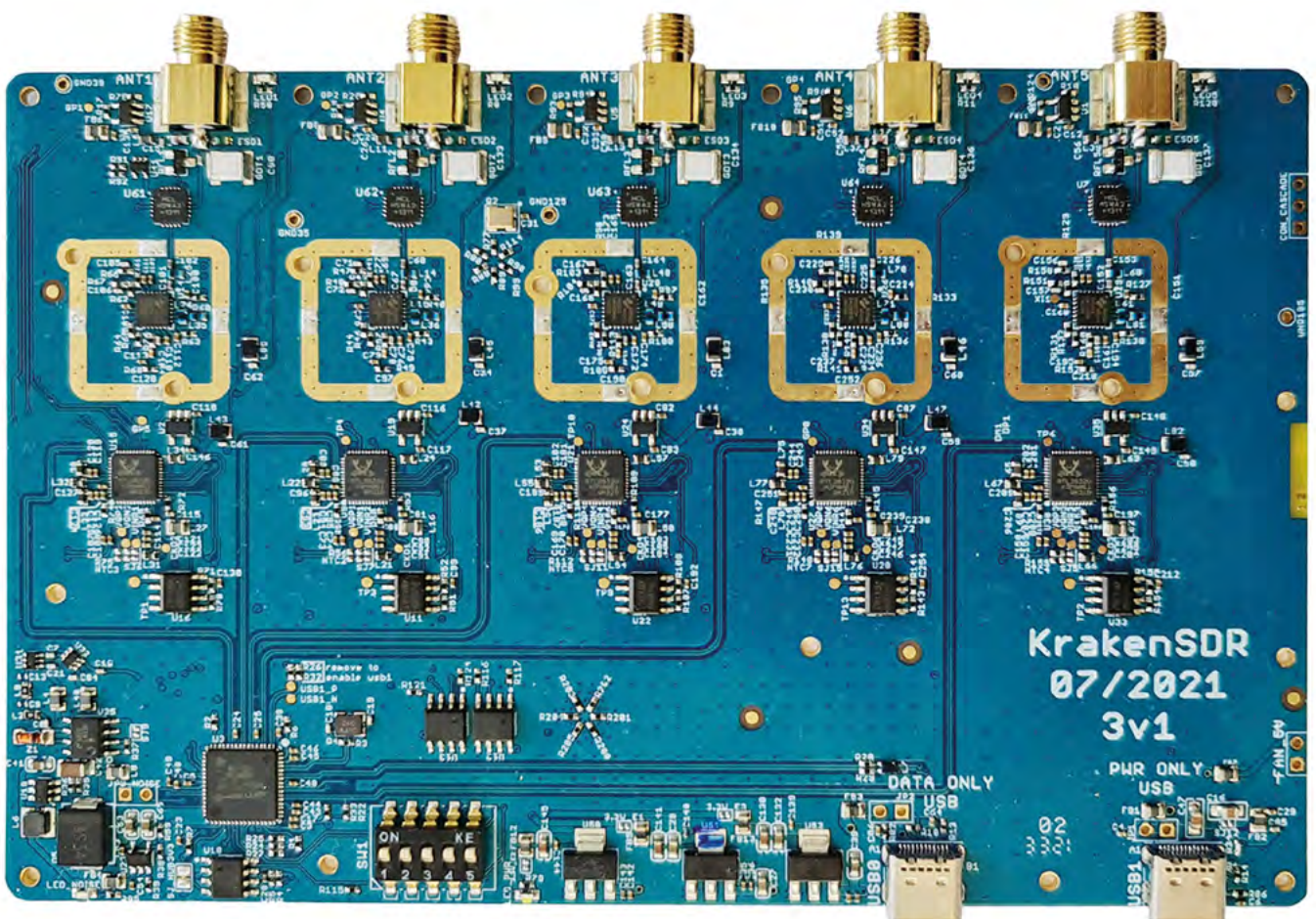

THE TOP SUPPLIERS. THE LATEST TECHNOLOGIES.



Digi-Key
ELECTRONICS
10,100,000
Components available online

ANALOG DEVICES
75,879
Unique products

TEXAS INSTRUMENTS
133,768
Unique products

FREE SHIPPING
ON ORDERS OVER
£33 OR \$50 USD*



0800 587 0991
DIGIKEY.CO.UK



2,000+ INDUSTRY-LEADING SUPPLIERS | 100% FRANCHISED DISTRIBUTOR

*A shipping charge of £12.00 will be billed on all orders of less than £33.00. A shipping charge of \$18.00 USD will be billed on all orders of less than \$50.00 USD. All orders are shipped via UPS, Federal Express, or DHL for delivery within 1-3 days (dependent on final destination). No handling fees. All prices are in British pound sterling or United States dollar. Digi-Key is a franchised distributor for all supplier partners. New products added daily. Digi-Key and Digi-Key Electronics are registered trademarks of Digi-Key Electronics in the U.S. and other countries. © 2021 Digi-Key Electronics, 701 Brooks Ave. South, Thief River Falls, MN 56701, USA



LENS

HACK | MAKE | BUILD | CREATE

Uncover the technology that's powering the future

PG
44

HOW I MADE: DIY FILM SCANNER

Digitise family memories with a Raspberry Pi, 3D printing, and a spark of brilliance

PG
52

INTERVIEW: SAM TOPLEY

We love DIY electric musical instruments, especially when they're so warm and soft



PG
58

IMPROVISER'S TOOLBOX

Give empty drinks receptacles a new lease of creative life

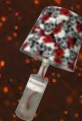

PG
32

INTELLIGENT

LEGO®

Build brains into your bricks with these smart projects

CODE WITH

LEGO®

Power up your bricks
with LEGO® Technic™ Hub
or Raspberry Pi



LEGO® is one of the gateways into making for many people. These little plastic bricks are the perfect compromise on ease of use and functionality for developing minds to express their creativity in a physical form.

Thanks to a programmable electronics system, you can expand your builds with technology to add motion or sensing. LEGO® has created some really easy ways to get started programming these electronics. If you've not used LEGO® in a while, you might be surprised to know that LEGO® offers one of the easiest introductions to programming. We'll look at their Icon Block and Word Block systems that offer drag-and-drop coding to make your bricks light up, beep, or move. You can even take a step further and code your brick-based builds in MicroPython.

Microcontrollers are a great choice for powering LEGO® bricks – the technology stack is simple and easy to use. However, sometimes you need a little more processing power for your builds. The new Build HAT lets you connect a Raspberry Pi computer to your LEGO® electronics. This means you've got the processing power and connectivity to grab data from the internet, process images using machine learning, and interact with a huge range of other hardware. There's a whole lot more possible with LEGO® than there used to be. →

Getting started

The LEGO® Technic Hub offers an easy route into the world of programming

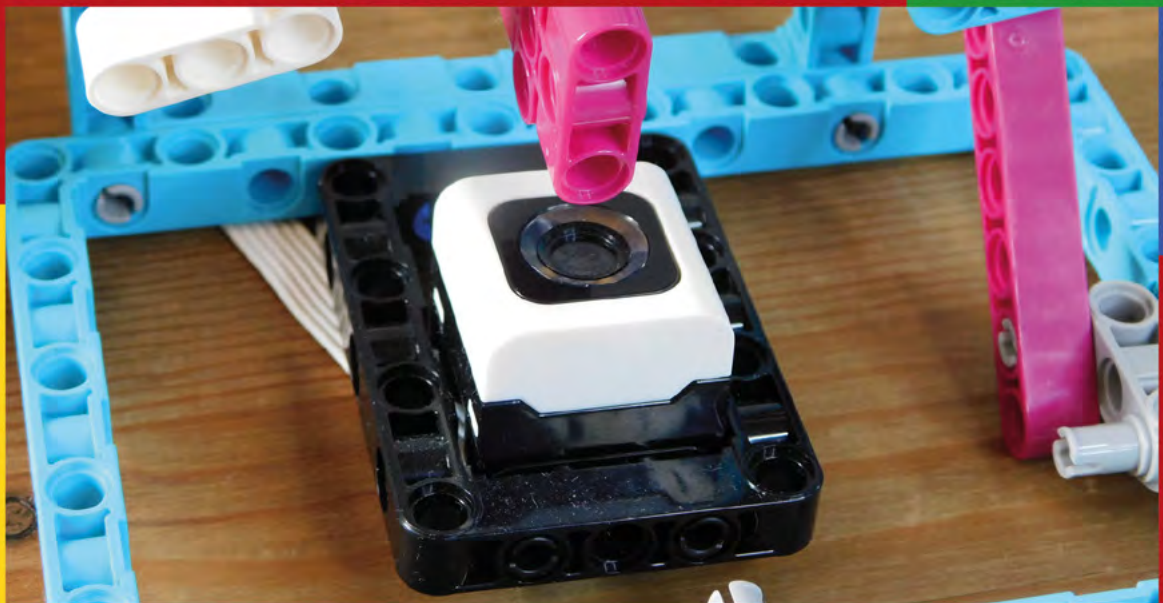

The LEGO® Technic Hub comes in a few forms, but the basic thing that you need to look at is the number of connections (the same LPF2 connectors are used for both inputs and outputs). There are also a couple

of different apps that are used to program the Hub, depending on which version you use. We've used the Hubs that work with the SPIKE Prime app, but others use the Powered UP app. There are also the MINDSTORMS kits, which use the Robot Inventor app.

It's programmable in three ways: Icon Blocks, Word Blocks, or with MicroPython. The first two are based on Scratch and use drag-and-drop coding, while the latter is a more traditional programming language.

Icon Blocks is a stripped-down programming environment. You've got access to the features of the

hardware, but fewer language features. There are no variables, and the concept of 'if' statements doesn't exist. You can create multiple code paths by defining different starting conditions for each (for example, you can have a piece of code run when a button is pressed).

Word Blocks and MicroPython have broadly the same set of features, and give you quite a bit of control over the hardware.

Let's take a look at a simple program for making music. There's a buzzer in the Hub, so we can generate notes. We're going to use the colour sensor to decide what notes to play. At this point, you could play this rudimentary instrument any way you want. We've built a contraption with a rotating wheel on which we've hung different coloured bricks. As the wheel spins, bricks drop over the colour sensor and different notes are played.

Above  The colour sensor can detect what colour brick is above it



Above  Our simple sequencer just loops around a selection of bricks to make a tune

Let's take a look at the MicroPython code for this:

```
from spike import PrimeHub, LightMatrix, Button,
StatusLight, Speaker, ColorSensor, App, Motor,
Timer
from spike.control import wait_for_seconds, wait_until,
Timer
from math import *

import time

hub = PrimeHub()
motor = Motor('B')
color = ColorSensor('D')
motor.start(10)

while(True):
    current_color = color.get_color()
    print(current_color)
    if(current_color == 'violet'):
        hub.speaker.start_beep(60)
    if(current_color == 'white'):
        hub.speaker.start_beep(55)
    if(current_color == 'white'):
        hub.speaker.start_beep(50)
    if(current_color == 'yellow'):
        hub.speaker.start_beep(70)
    if(current_color == 'cyan'):
        hub.speaker.start_beep(80)
    if(current_color == None):
        hub.speaker.stop()
    time.sleep(0.5)
```

In this example code, we've got a motor attached to port B and a colour sensor attached to port D.

We're running the motor at 10% speed, and it beeps away different notes depending on what colour brick is in front of the sensor. →

HARDWARE

MOTOR – MEDIUM OR LARGE

The LEGO® motors include position sensors, allowing you to turn them at a precise speed or to a precise angle. This means that you can use them as you would a servo or stepper motor, as well as a usual DC motor. You can even use the position sensor without rotating the motor, which lets you use it as a rotary encoder.

This positioning is accurate to a few degrees. You can maximise this by gearing down the motor, which reduces any positioning errors.



COLOUR SENSOR

This returns the colour of the brick in front of the sensor. Obviously, it doesn't have to be a brick, but the sensor is tuned to the palette of the LEGO® components in the SPIKE Prime sets. With a bit of imagination, this can be a really useful component. You can turn a slider of multiple bricks into an input device, automatically sort your bricks by colour, or – as we'll see – build a music synthesizer.



FORCE SENSOR

You can use this as a simple button, but it can also detect force up to 10 Newtons. You can use this to control motor speed, change the pitch of a note being played, or anything else where you need to get a range of input from the user.



DISTANCE SENSOR

If you're making robots and don't want them to crash into things, this is what you want. It can detect distances between 1 cm and 2 m with +/- 1 cm accuracy. Perfect for avoiding walls or household pets. If you're of a musical bent, this can also be used for making your own theremin, or other instruments.



LEGO Projects

Here are a few of our favourite coded LEGO® projects

Rubik's cube solver

hsmag.cc/PrimeCuber

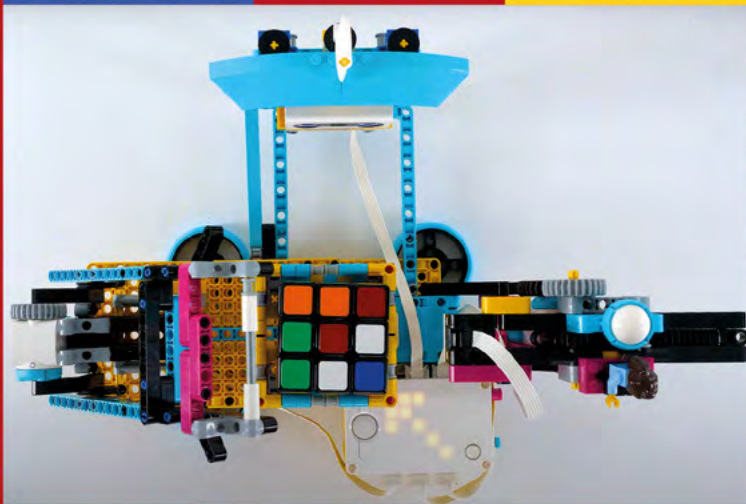

The colour sensor is put to good use in this Rubik's cube solver. Two motors spin the cube while another positions the sensor. The solving is handled automatically, so just drop in your scrambled cube, and watch as your robotic assistant rotates it to uniformly coloured completion.



Hexapod robot

hsmag.cc/HexapodRobot

You might think that a hexapod robot would need at least six motors, but with some clever linkages, YouTuber Dimitri Dekyvere manages to get this walking robot built with just three. There's also an articulated tail to add a scorpion-like look to the electromechanical creation.

Electric screwdriver

hsmag.cc/ElecScrew



Why buy an electric screwdriver when you can spend more money making your own? Well, while this is perhaps not the most featureful screwdriver around, it's a fun way to test out the speed and torque implications of different gearing.



Marble machine

hsmag.cc/LegoMarbles

It's a universally agreed fact that it's mesmerising to watch marbles roll down runs, but it's a chore to pick them up and start them once they've reached the bottom. Save yourself the bother by packing a motor in there and get it to lift up the marbles itself.

Guitar

hsmag.cc/LegoGuitar

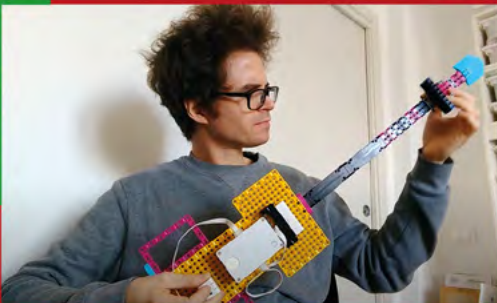

Musical instrument builds are a fun way to express your creative side – both in the build and in playing it. The Technic Hub has an in-built speaker, and this guitar build gives you a way of playing it. Purists will claim that without strings this isn't a real guitar, but that's only because they're jealous of its sweet brick-based sound.



Lawn-mower

hsmag.cc/LegoLawnMower

Do you waste your precious free time hacking away at invasive green stuff in your garden? You could save this time by letting it grow wild and providing a haven for invertebrates and other small animals. Alternatively, automate the trim with a LEGO® robot that spins its way through the overgrowth. →

Raspberry Pi Build HAT

Integrate the Raspberry Pi (plus the whole of the internet)

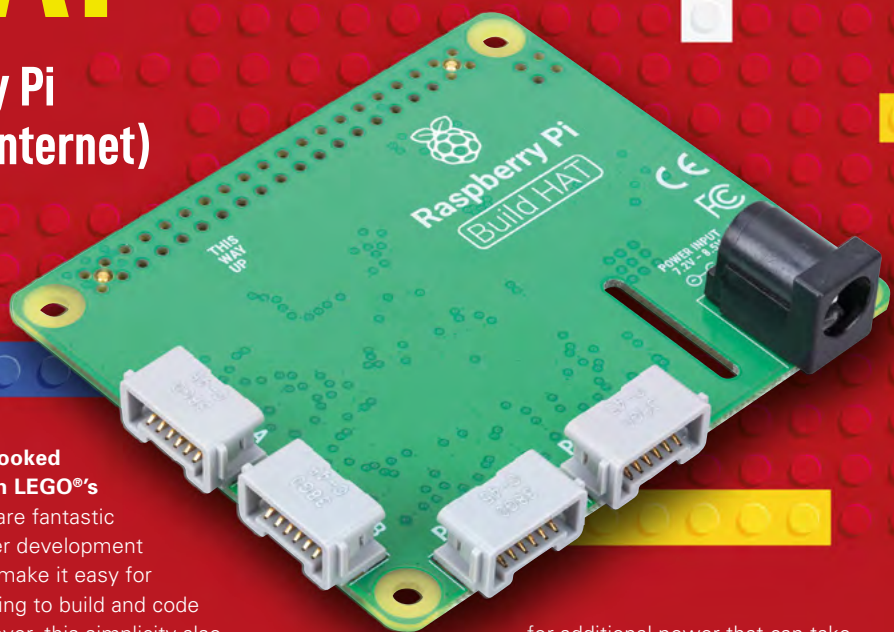

So far, we've looked at builds with LEGO's Hubs. These are fantastic microcontroller development systems that make it easy for

people new to programming to build and code their own systems. However, this simplicity also means that they don't have access to the sheer range of capabilities of some other systems. This is where the Build HAT comes into its own.

Using the Build HAT, you can connect a Raspberry Pi computer to the motors and sensors of the LEGO Technic and SPIKE Prime systems. You get access to the full range of LEGO hardware and also all the software of the Raspberry Pi ecosystem, and this enables you to create far more complex builds.

There are four LPF2 connectors for your LEGO parts. The Build HAT will block access to the GPIO pins unless you use header extenders. These pop straight through the HAT and let you access the pins if you want to attach other hardware. The Build HAT uses GPIOs 14 and 15, so as long as the additional hardware you want to use doesn't need these, then you can plug it straight in. If you're adding an additional HAT, then you can check what pins it needs at pinout.xyz.

While you can power the Build HAT from Raspberry Pi, some of the accessories need more than the 5V that Raspberry Pi headers can provide. There's a barrel jack

for additional power that can take 7.2V – 8.5V. Raspberry Pi has released a power supply for this, which works great for projects that can have a power cord. If you want to make something more portable, you'll need a battery solution. This could be a set of AA batteries or a 2S LiPo battery.

There's a cutout for the camera connector, so the full range of Raspberry Pi inputs is available.

On the software side, there's a Python library – you can find full details of how to install and use this at: hsmag.cc/BuildHatIntro.

One particularly useful feature of the Python library (which it has in common with MicroPython on the Hub) is the concept of motor pairs. This allows you to use two motors in sync. The Build HAT (or Hub) will use the encoder information from the motors to make sure they're running at the correct speed. If you've built robots before, you might be aware that it can be tricky to go in a straight line. Two motors are never quite identical, so even when powered the same, they will tend to run at slightly different speeds. If you've got one

Above  All the components are on the underside of the HAT, leaving the topside clear

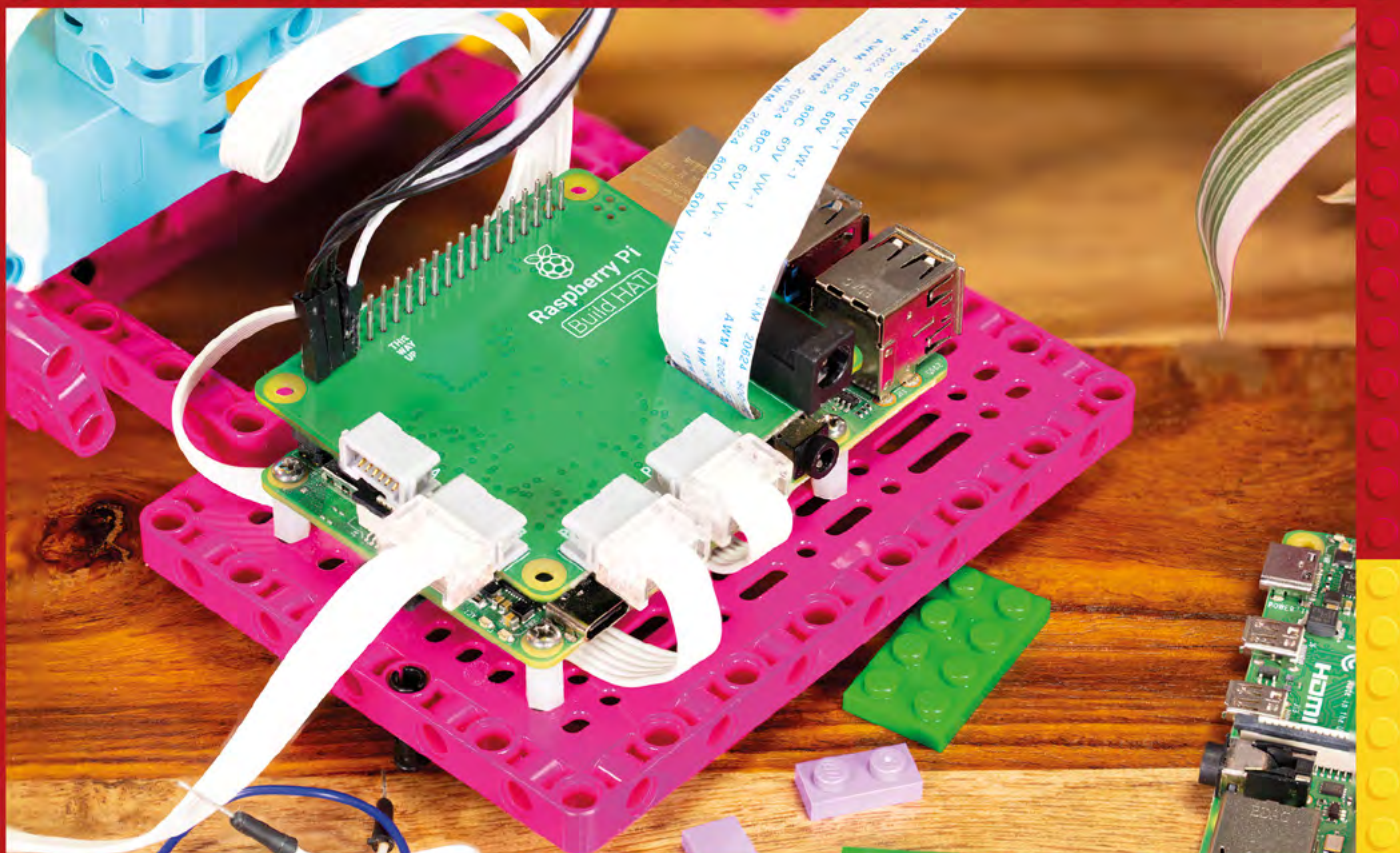

Above  The Maker Plate is the first product that LEGO® has ever created that's designed to connect to something other than LEGO®.

Below  The Build HAT is powered by the same RP2040 microcontroller as Raspberry Pi Pico

powering each side of the robot, it will tend to veer off course. This setup avoids that.

As someone who grew up with LEGO® models (and a treasured LEGO® Technic set), this author is excited to see what you – the maker community – do with this. It lets you combine data, sensors, and actuators together quickly and easily to create almost anything, in the same way that a box full of coloured bricks lets you create an almost endless set of models. →

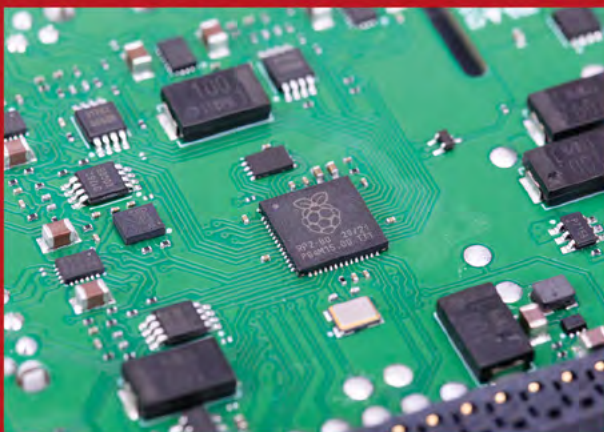

MAKER PLATE

LEGO® is designed to connect to other LEGO®. Through a well-thought-out system of bumps (spots) and clever spacing, it's easy to connect bricks, bars, axles, mini-figures, and other assorted bits and bobs together to make, well, almost anything. The Build HAT changes this slightly because it means you have to introduce something that's not LEGO® into your system. Due to a frankly unforgivable oversight, back in 2012 when the Raspberry Pi team first created the form factor that we now know as 'Model B', they forgot to add plastic spots to the bottom, and so we can't slot it nicely into our LEGO® builds.

Creative makers should have no problems devising a brick-based solution to this, but for a more permanent solution, LEGO® has created the Maker Plate, which you'll find included in the Spike Prime Expansion Set (hsmag.cc/SpikePrimeExpansion – however, the Maker Plate is not included in older versions of the Expansion Set).

Build HAT projects

Super-powered brick builds

Despite being a brand new project, there's already a great selection of projects that you can build or adapt to your own ends. Here are a few of our favourites from projects.raspberrypi.org. We've no doubt that there will be loads more examples across the internet in the coming weeks and months.

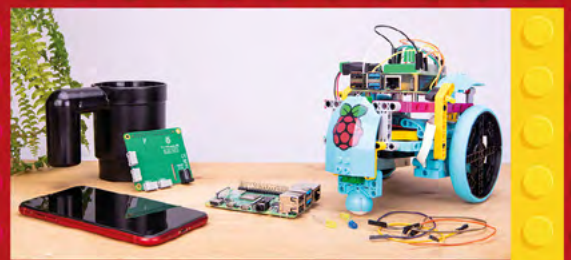

Remote-controlled car

hsmag.cc/RCLegoCar

Raspberry Pi's built-in Bluetooth can get data from other Bluetooth devices, such as a smartphone. This project uses the BlueDot library to get information from your phone to your Raspberry Pi, and uses this to control a buggy. You can use a similar technique to control your buggy using other games controllers. Or, you could add a camera or other sensors to make the buggy self-driving.

Face

hsmag.cc/RobotFace

Do you anthropomorphise electromechanical contraptions? Then this is the project for you. It adds an expressive face that can smile and frown depending on what object is in front of the camera. This project uses TensorFlow to recognise what objects are on display, and change the face appropriately, but you can program the face to react to anything.

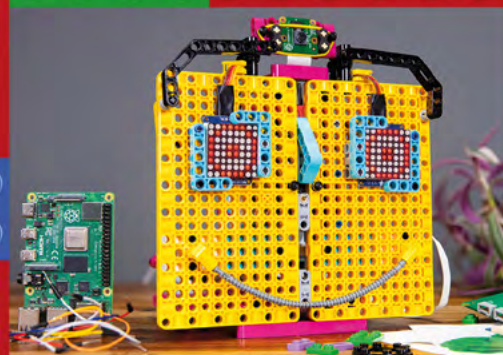

Dashboard

hsmag.cc/LegoDash

There's a huge amount of data available to us. Some of it from online sources (such as weather forecasts), others from sensors we can attach to a Raspberry Pi. The hard part isn't getting information, it's displaying it in a way that's both useful and interesting. Numbers on a screen are easily overlooked, and sometimes it feels like we live in a world of blinking LEDs. How about a LEGO® information dashboard? You can use the motors combined with other hardware attached to Raspberry Pi to build a system of dials and gauges to create an interesting, informative, and aesthetic display.

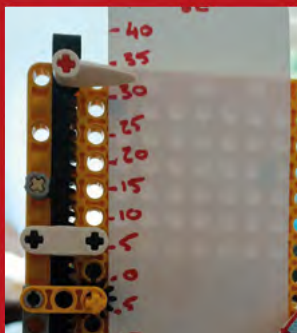

Plotter

hsmag.cc/PlotterLego

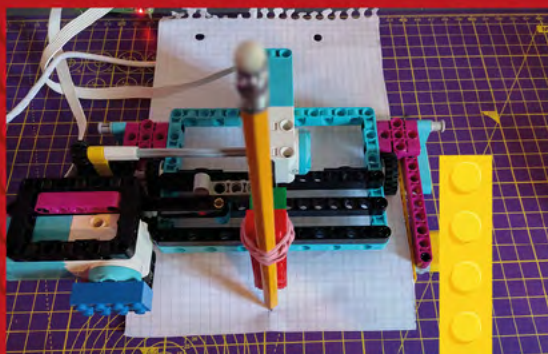

There's something mesmerising about watching a robotically controlled pen drawing on some paper. It's the 1980s equivalent of watching a 3D printer run, though usually a little faster and easier to see what's going on. This particular project is designed to output data – think a Hollywood-style seismograph or polygraph but made of LEGO®. What information should you plot out? How about temperature, pollution, or the skin resistance of a supervillain you're questioning? □

Games controller

hsmag.cc/LegoController

The LEGO® motors also have encoders built-in that enable them to sense their position. In normal operation, this means you can set their speed precisely, or rotate to a specific angle. However, you can also read the position of the wheel without activating the motor. This lets you use the motor as a rotary encoder. In this project, the motors are used to control a game of Pong, but you can also use them as input for almost any program you're writing.

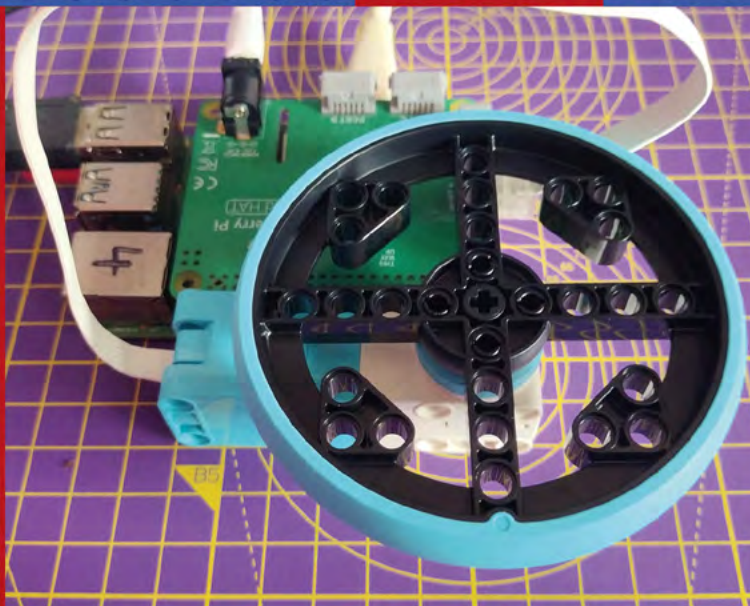

SUBSCRIBE TODAY

FOR JUST £10

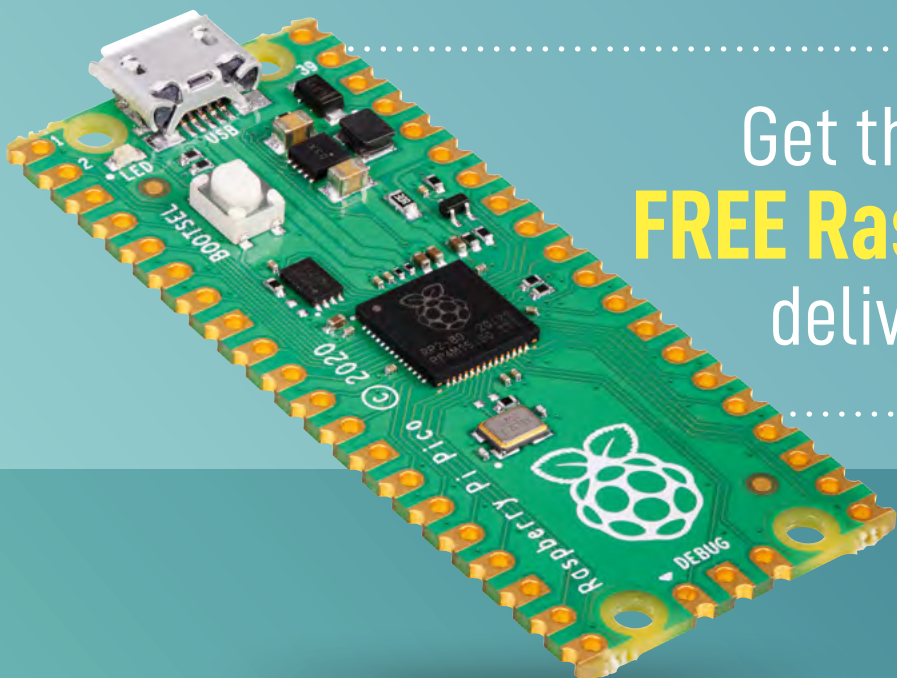

Get three issues plus a
FREE Raspberry Pi Pico
delivered to your door

..... hsmag.cc/FreePico

UK offer only. Not in the UK?
Save money and get your
issue delivered straight to your
door at hsmag.cc/subscribe.
See page 66 for details.

Subscription will continue quarterly unless cancelled

SUBSCRIBE on app stores

From £2.29



Buy now: hsmag.cc/subscribe

Free Pico with print subscription only



MAKE | BUILD | HACK | CREATE

HackSpace

MAKE | BUILD | HACK | CREATE
TECHNOLOGY IN YOUR HANDS hsmag.cc | December 2021 | Issue #49

SAVE 44%

CODE WITH LEGO
Power up your bricks with LEGO® Technic™ Hub or Raspberry Pi

Stereo photography
Explore the magic of 3D images

Security
Make your own lock picking tools

GLASS PURE DATA GRAFFITI

MAKE | BUILD | HACK | CREATE
TECHNOLOGY IN YOUR HANDS hsmag.cc | October 2021 | Issue #47

est D prints

LORA
Adding long-range radio to a project

Essential builds for your home, office, and workshop

LED S PICO BUBBLE **NO SMD PURE DATA**

How I Made A RASPBERRY PI FILM SCANNER

Bringing cellulose to the 21st Century

By Anton Gutscher

Before smartphones and video cameras, there was a period of time where memories were captured on film. In 1932

Eastman Kodak launched their 8mm film, now known as Standard 8 or Regular 8, and it became popular very quickly. 8mm filming had its peak of popularity in the 1950s to the 1980s, after which it became rapidly replaced by video cameras. Mostly captured without sound – wonderful memories nevertheless – it made home movies possible for a large audience for the first time.

When my grand-aunt passed, she left behind a tremendous amount of film reels. Family events, as well as holidays, had been captured in the dozens over the years and stored in boxes in the basement.

Feeling responsible and curious at the same time, I looked at the options of



bringing the content into the 21st century, having them available for all family members on modern equipment such as tablets, smartphones, computers, and TVs.

One possibility would have been to get them digitised. There are companies out there offering exactly that, and I used such a service for a few reels from another family member some years back. The result was really good, but bringing hundreds of reels with unknown content to such a service seemed a bit odd and costly to me.

So I looked into commercially available film scanners. There are a few out there, but reading the reviews wasn't very encouraging.

One day I stumbled upon an article about a guy using a Raspberry Pi to capture films using an old film projector. Since I didn't have any projector, that wasn't really an option for me, but it sparked the idea of using a Raspberry Pi Camera to capture film, frame by frame and using a stepper motor for film transportation.

One day I stumbled upon an article about a guy using a Raspberry Pi to capture films

The two most popular film formats were Regular 8 and Super 8. The '8' stands for the width of the film in millimetres. The picture frames are even smaller: 4.5 × 3.3mm for Regular 8 and 5.5 × 4mm for Super 8, because a part of the filmstrip has sprocket holes for film transportation in the camera during filming.

So the first thing I needed to know was if and how the Raspberry Pi Camera would be capable of taking a picture of the tiny film frames in good quality.

PICTURE-PERFECT

Firstly, I 3D-printed a small adjustable camera mount that allowed me to experiment with different settings. While impressed by the quality of the camera itself, I noticed that the field of view is much too large for the tiny film frames. I had a clip-on macro lens for smartphones laying around – I tried this and it worked! The frame now took about 40% of the field of view, just enough to avoid the distortion of the lens on the sides.

While I've learnt that the camera with the additional macro lens would be capable of capturing these tiny pictures in reasonably good quality, I also needed to find a way of consistent lighting through the film. An LED under an acrylic sheet for diffusion did the trick. While the light tapered off slightly towards the edges, it didn't matter too much since these parts would be cropped away.

Now it was time to look at the next challenge – moving the film frame by frame.

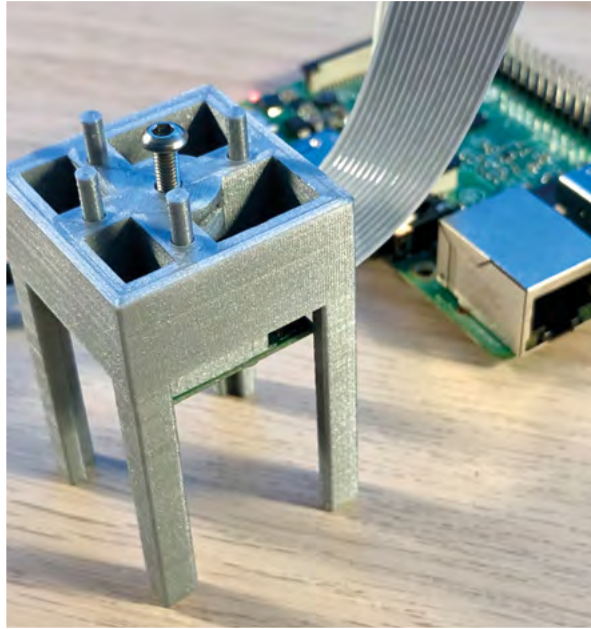

Left ♦ 3D printing let me rapidly iterate this design

Below ♦ Precisely moving the film proved to be the hardest problem

I started experimenting with a simple 28BYJ-48 stepper motor. These motors are inexpensive and easy to control with the Raspberry Pi. Moving the film with a 3D-printed sprocket worked fine, but it was not precise enough. Given the height of only 3–4 mm for a frame, even a tenth of a millimetre variation in film transportation makes a visible jitter once you view the pictures stitched together as film.

So I read up on stepper motors and decided to try a bipolar NEMA 14 0.9° stepper motor without gear. This motor →

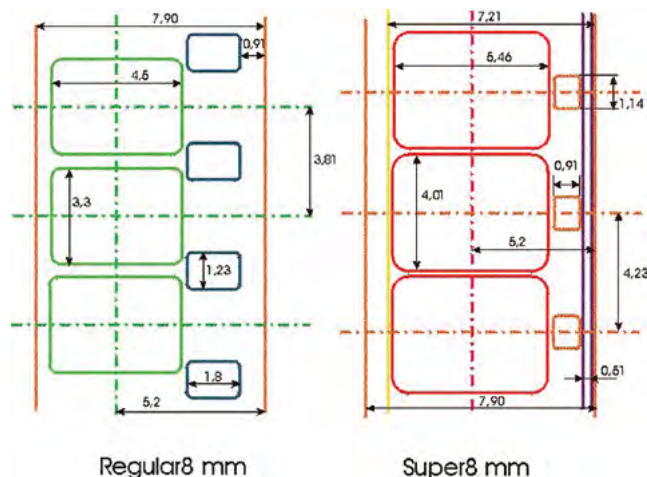
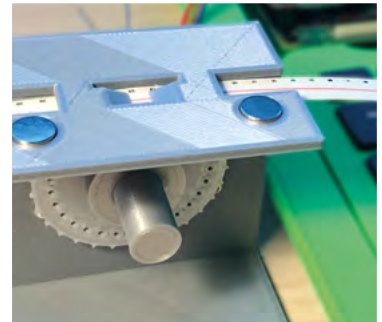

Right ♦ The two 8mm formats have slightly different dimensions

FEATURE



Right ♦
The camera is held in place by a 3D printed mount

Below ♦
Accurate lighting is essential

Using wooden building blocks, I made a frame to hold the film reel and could, for the first time, scan thousands of frames in one go

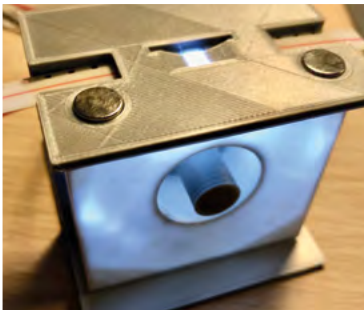

also required a different motor driver. I used the DRV8825 stepper motor driver. The results have been very promising, so I continued optimising the film transport with this motor. Using my son's 'MATADOR' wooden building bricks, I made a frame to hold the film reel and could, for the first time, scan thousands of frames in one go. Thousands may sound a lot, but considering that Regular 8 was usually filmed with 16 frames per second and Super 8 with 18 frames per second, a single minute of film takes about 1000 frames.

This setup allowed me to optimise the camera settings, but it also revealed some problems.

The stepper motor got warm during operation, around 50°C, which seemed normal, so nothing to worry about, I thought. But after scanning for a longer period of time, I realised that the film

adjustment was way off and the transport wasn't working as precisely as before. I noticed that the

Left ♦
The lighting dims a little towards the edge, but this doesn't affect the scan

film transport sprocket was not sitting firmly on the motor axle anymore. Looking at the 3D-printed mount plate, I saw small changes in the geometry. Not a lot, but enough to cause the setup to not work as it should.

I had printed all parts in PLA, which I thought should have no problem handling such moderate temperatures, but it did. So I took a spool of ABS, reprinted the mount plate of the stepper motor as well as the sprocket, and never had that problem again.

A much bigger challenge was sections where parts of the films had been glued together. At these points, the film is slightly thicker, which would sometimes cause problems with the film transport. While watching the scanning process on the screen, I could instantly spot it; however, the machine needed to run unattended for hours. This was a real headache. After experimenting on the film transport parts, I concluded that I could not fix it by only mechanical improvements and that I, therefore, needed another solution for the problem. If only the machine could see what I see when I watch it running into the problem ... Well, I already had a camera taking a picture of every single frame; why not use it for a quality check?

I read up on computer visualisation, and after overcoming some struggles installing OpenCV on my Raspberry Pi, I did some

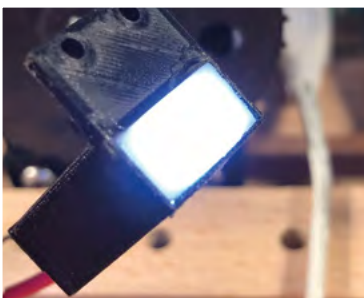

experiments with it. That opened a whole new range of possibilities! Not only could the Raspberry Pi now check on every single frame if it was adjusted correctly, but using the sprocket holes on the film as reference, it could also automatically correct the position before saving the picture by adjusting the film with the stepper motor. What a breakthrough! In hindsight, this technology may have made it possible to use the cheaper 28BYJ-48 stepper motor and adjust the inherent imprecision, but at that time, the design was too much centred around the NEMA 14 already, so I did not want to change it anymore.

The only thing left to do was optimise the part of the picture analysed by OpenCV in order to reduce calculating time. Since the only part really relevant was the sprocket holes on the filmstrip, I cropped out just that area for analysis.

There was one more thing this technology enabled: it allowed precise automatic cropping of the individual pictures of the frames. Every imprecision of the



Left ♦
The sprocket feeds the film along

Below ♦
I brought all the electronics together onto a HAT

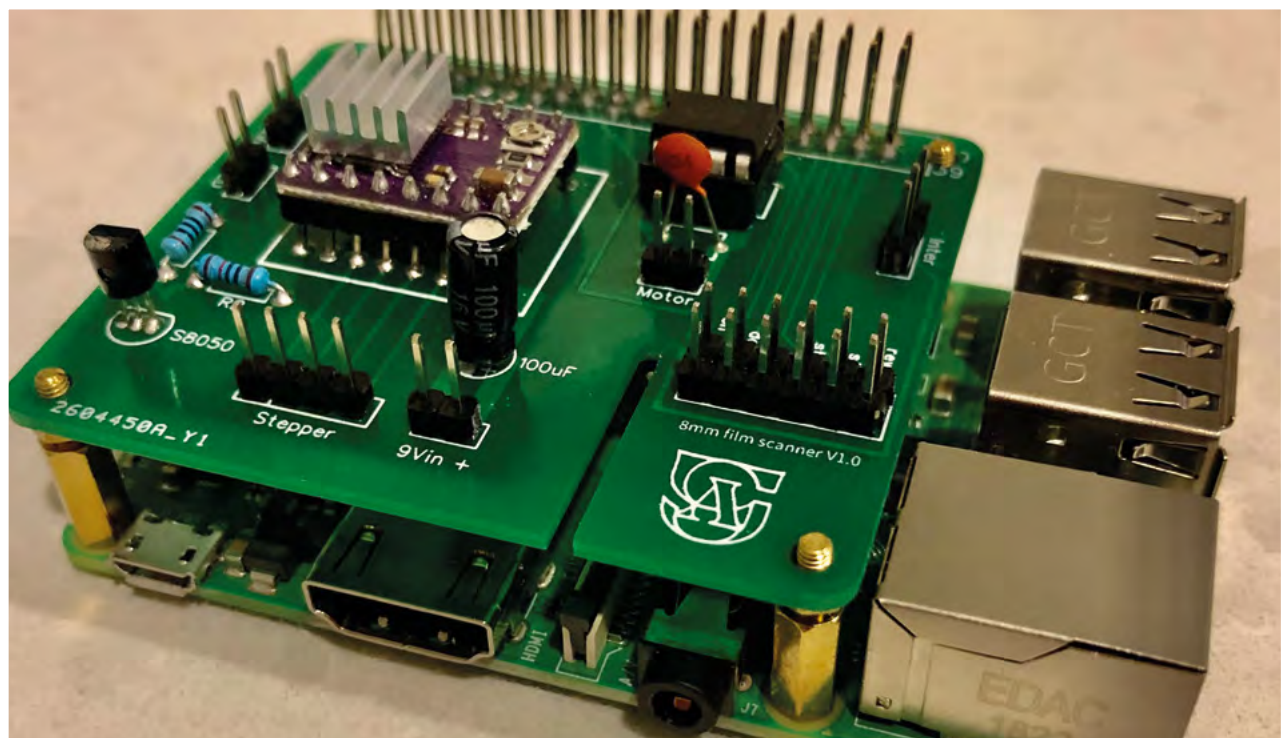

FEATURE

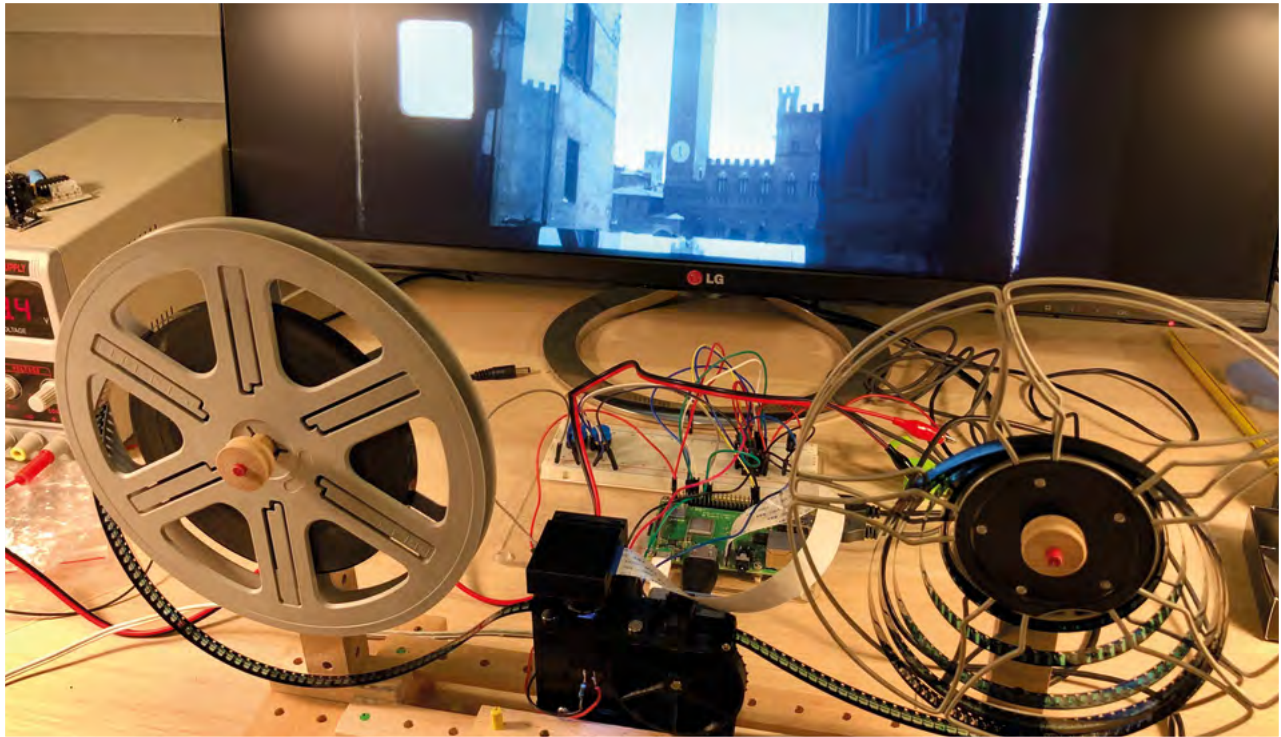

Above ♦
The magic of finally seeing the old film is hard to describe

Below ♦
I designed and tested the project using a breadboard

transportation could be compensated by exact cropping, as long as the complete frame was scanned. So while at first it looked like a workaround for a problem caused by the mechanics, OpenCV became a key element of the project.

Originally, I thought I would process the individually scanned frames outside the machine on another computer, using video editing tools. But having now precisely

cropped frames made me think it would be possible that it could all be done in one go – scanning, cropping, stitching, from the film reel to the digital copy of the film. Again, I searched the internet for software that could stitch frames to a movie on the Raspberry Pi and I found FFmpeg, which did exactly what I needed.

With the increasing complexity of the project design, the tool I used to design simple geometries for 3D printing became a bottleneck. I started this project using Tinkercad, easy to learn and use software. But now, I needed something that could simplify design changes and provide me with additional design tools, so I started to learn Autodesk's Fusion 360 since the internet seemed to be full of makers using it. It was not an easy start, and many things that feel so intuitive by now made me struggle in this first project. But it was totally worth the learning effort. It became one of my most appreciated pieces of software, and I cannot imagine having done many of my other projects without it.

With this new tool in place, I redesigned practically everything and added the holders for the film reels as well as the casing for the Raspberry Pi and the other electronics.

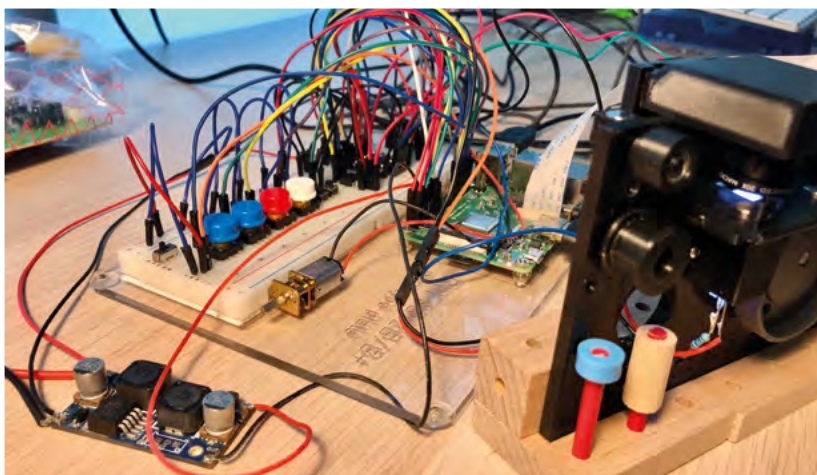

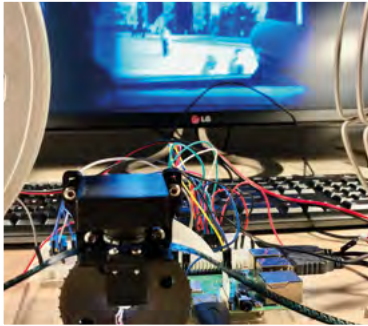

Above ♦
With everything working properly, it was time to tidy up the build

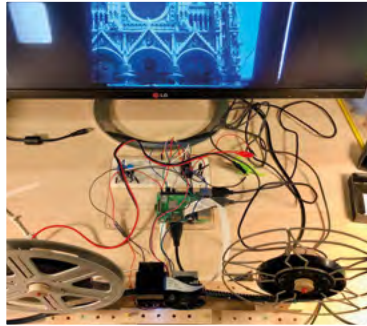

Above ♦
If you want to scan your own 8mm films, head to hsmag.cc/8mm

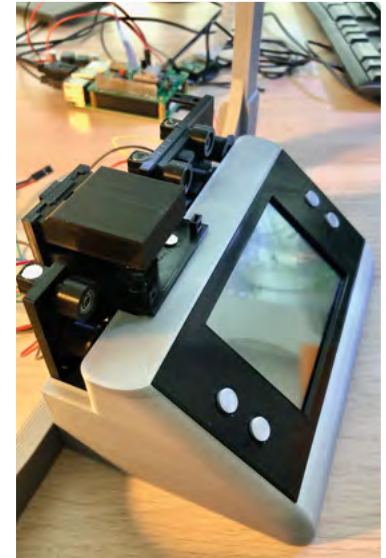

Above ♦
The final build is kept safe in a custom-designed enclosure

Since I planned to potentially build more than one of these scanners, in order to hand them over to other family members so they too can scan their films, I decided to go with a custom PCB to make the assembly easier. I designed the PCB as a Raspberry Pi HAT and ordered five pieces online. It took about a week until the PCBs arrived. I soldered the parts in place and put everything together. I was really happy with the compact design. I was ready for the first scan of a film reel with the fully assembled machine.

It worked well – until it didn't.

Since the Raspberry Pi and the other electronic components have always just been lying on my desk, it never crossed my mind that rising temperatures in an enclosed case will ultimately cause problems. After about half an hour, it got

too warm for the Raspberry Pi's liking and started indicating it. So I changed the design of the case, adding air vents and also putting a heatsink on the Raspberry Pi's CPU, which I hoped would be enough since I did not want to add a cooling fan into this already cram-full machine.

LIGHTS, CAMERA, ACTION

It was time for another test.

I took a film reel that had 'Singapore 1976' on the box. It seemed that my grand-aunt had been there on a holiday in 1976. Since I live in Singapore, I was especially curious to watch this one, and I thought it's the appropriate first film to scan entirely with my (hopefully) completed little machine. All went well, and after a while, the ready-to-watch digital version of a

holiday memory from 1976 was ready to be seen for the first time after its long sleep in a box in the basement.

Seeing the city how it looked so many years ago through the eyes of my grand-aunt, seeing the people she filmed, young and old, moments of her experience being in Singapore more than 40 years ago. It made me appreciate these little time capsules and feel proud that I could bring them to life again with such a simple machine.

This project was as exciting as it was challenging. While building and troubleshooting, I found so much useful information on the internet that helped me to learn, understand, and get inspired, that I really wanted to give back something, so I've put all the information on how to build this scanner online for anyone to access (hsmag.cc/dsvNHR).

In hindsight, there are things I would do differently. Maybe I will make another version of it one day, hopefully someone else will. I would be very happy if it would be because of this project. □

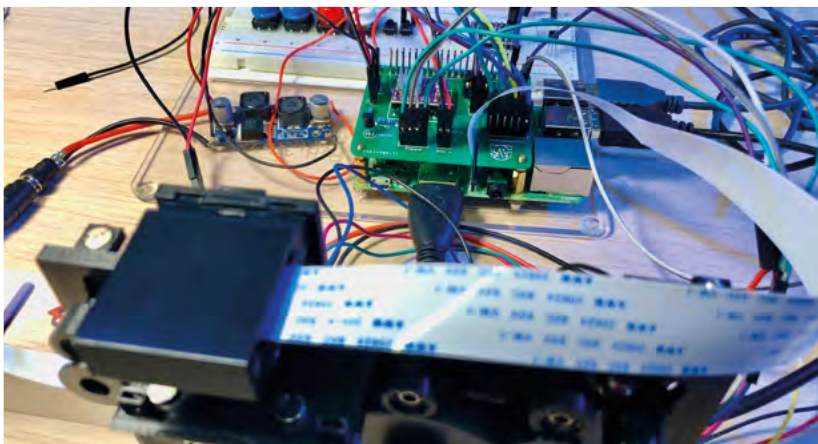

Left ♦
The HAT simplified the electronics

THE *Official*

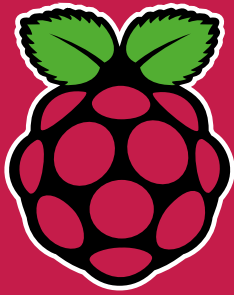

RASPBERRY PI HANDBOOK

2022

200 PAGES OF RASPBERRY PI

- QuickStart guide to setting up your Raspberry Pi computer
- Updated with Raspberry Pi Pico and all the latest kit
- The very best projects built by your Raspberry Pi community
- Discover incredible kit and tutorials for your projects

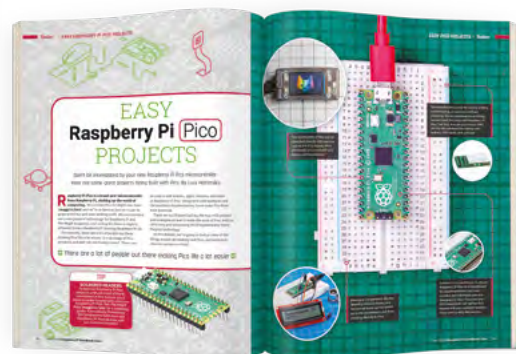
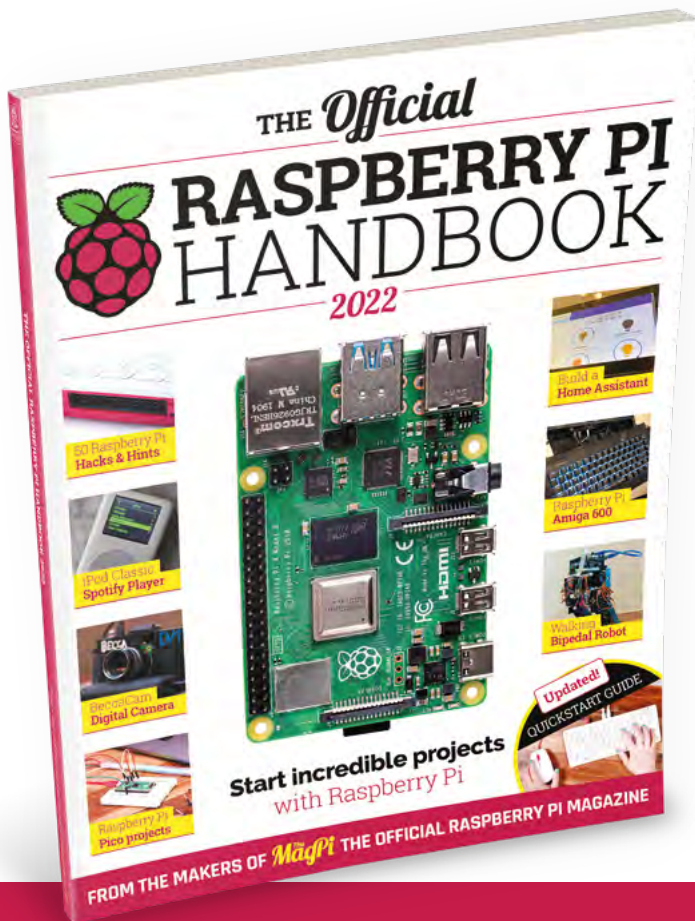

Buy online: magpi.cc/store

THE OFFICIAL Raspberry Pi Beginner's Guide

The only guide you
need to get started
with Raspberry Pi

Inside:

- Learn how to set up your Raspberry Pi, install an operating system, and start using it
- Follow step-by-step guides to code your own animations and games, using both the Scratch 3 and Python languages
- Create amazing projects by connecting electronic components to Raspberry Pi's GPIO pins

Plus much, much more!

£10 with **FREE**
worldwide delivery

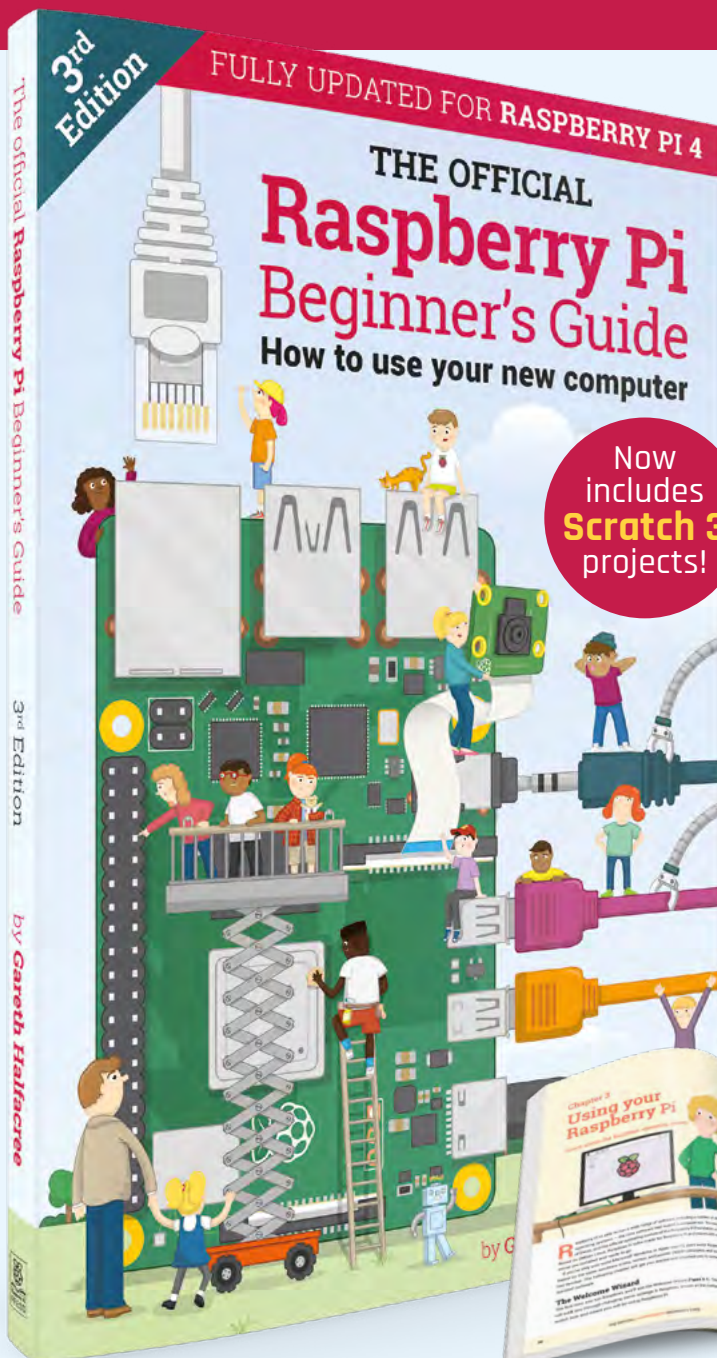

Buy online: magpi.cc/BGbook

HackSpace magazine meets...

Sam Topley

A triple node of craft skills, DIY audio, and electronics

Sam Topley is a musician, an electronics expert, and an impressively skilled worker of textiles, in particular wool. Where those three skills overlap in the imaginary Venn diagram of life, you'll find her brilliant work – circuits that both feel and sound fuzzy, pompoms that both look and sound loud, and a load of new ways to interact with synths. We spoke to Sam to find out what she's working on at the moment and what's going on in the DIY music scene, and why electronics, like music, is just another form of self-expression. >



Above ↕
Why use breadboards for circuits when you can use embroidery hoops?

HackSpace Morning Sam! You work at the Institute for Sonic Creativity. That's an epic title. It sounds like it should be headquartered in a hollowed-out volcano.

Sam Topley Oh, it's awesome. That's where I'm doing my PhD at the minute, at the Music Technology and Innovation Institute for Sonic Creativity, at De Montfort University in Leicester. I did my undergraduate degree and my master's degree. And now I'm doing my PhD there. It's such a fun place to be; there's a really, really good community, and lots of really interesting projects going on.

HS What sort of stuff are you doing there?

ST I'm investigating a craft-focused approach to electronic musical instrument building. The idea is that I'm putting craft, and in particular textile craft, at the forefront of an electronic musical instrument building practice – and just seeing what happens.

I'm not just doing pompoms – I'm doing some embroidery, I'm doing some knitting, some bits of weaving. All kinds of textile crafts, thinking about how they can be used in DIY electronics. It's a lot of fun. I don't want it to finish.

HS Why yarn? Why textiles?

ST Why not! My background is in music. I've always been interested in technology and electronics and computing, and I've also always been interested in textiles; since I was a teenager, I've been making my clothes and knitting and things like that. So, I think, why not? There's a lot of similarities in the way that we'd work with electronics and the way that we'd work with textiles.

Things like conductive thread can open up a whole new world for so many different possibilities. There's so much you can do with tactile objects and instruments and things.

HS Have you seen any divide or snobbery between electronics and programming and crafting?

ST Thankfully no. People are curious about these sort of new ways. So yes, I feel very welcomed. But, in the same breath, e-textiles are also making their own space within maker communities, which is really good as well.

HS What do you mean by e-textiles? I've seen conductive thread. Is there any more than that?

ST I'd use the phrase e-textiles to kind of broadly describe conductive materials, or any kind of textile materials with

Things like conductive thread can open up a whole new world for so many different possibilities

electronic properties. So you can get all sorts of types of conductive threads, depending on what kind of project you want to do. You can also get conductive yarns, conductive wool, fabric, all sorts of materials, really. And with these materials, you can make your own interfaces, or maybe you can stitch a circuit.

A lot of people who work with textiles would lean towards making wearable technologies. Not me personally. I'm more interested in object-orientated projects. It's a broad field.

HS What are you working on at the moment?

ST One of the main projects I've been working on for the last year or so is the noisy pompoms project, which is based

on a DIY kit that I've put together, whereby you can build your own pompom musical instruments. It's based on a cardboard box that contains all of the electronics and a speaker. And then you make your own pompoms to attach to this cardboard box, squeeze them and that makes sound. So the harder you squeeze the pompoms, the higher the pitch of the sound. It's quite a playful musical instrument that you can make yourself. The idea has been there for years and years and years, and it's had many iterations and versions of itself, but I feel like it's come into its own now. It's mature as a result of being stuck at home during the lockdowns last March. You can make your pompom at home, you don't have to have access to a specialist kind of makerspace; you can do it at the kitchen table if you want to, and it doesn't require any kind of specialist materials.

And since developing the kit, I've been doing some online workshops and, thankfully, now some face-to-face workshops too. I'm really just getting stuck into that.

Making a new instrument together in a workshop space, whether it be online or in a physical space, it gets you thinking about how we can make music together. That's really been keeping me busy for the last year.

HS You describe yourself as a sound artist on your website. What's the difference between a sound artist and a musician?

ST I've toyed with this a lot. I think when somebody asks 'what do you do?', I can say that I'm a musician. But then the next question is 'what do you play?' If you say that you're a sound artist, the next question is 'what do you make?' It opens up more questions. I make my own instruments; I make artworks that make sound. If you're a musician, that means you're a saxophonist or whatever. That's why I like to use that term. →

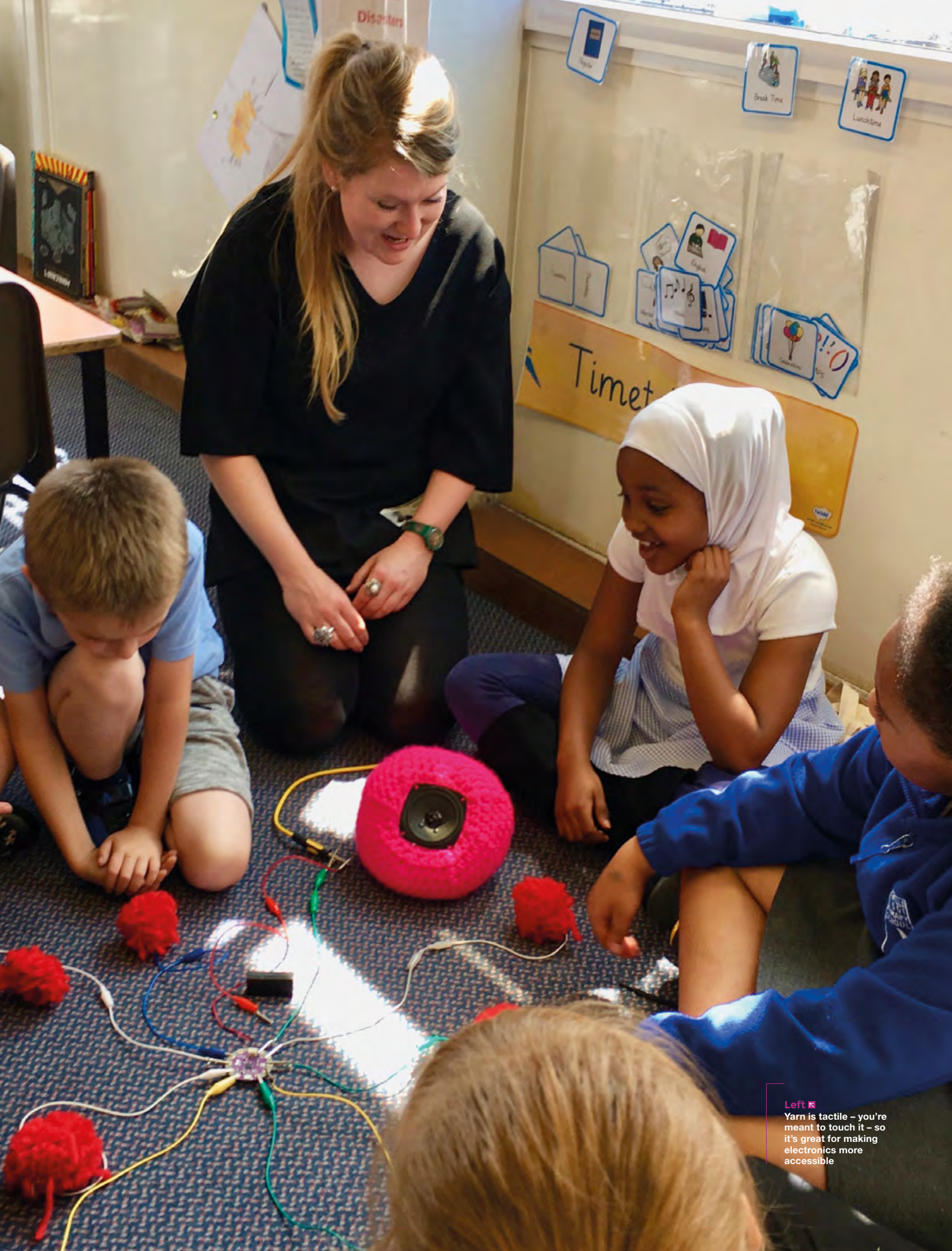

Left  Yarn is tactile – you're meant to touch it – so it's great for making electronics more accessible

HS What's wrong with guitars and harpsichords and making music on already-existing instruments? If it was good enough for JS Bach, why isn't it good enough for you?

ST There's obviously nothing wrong with those instruments at all. But there's always space for new music, new ideas. Especially with making your own instruments, there's scope for a whole host of new kinds of music – just as the harpsichord was new, the guitar was a new instrument all those hundreds of years ago. Why not carry on that tradition of inventing new instruments and new kinds of music that go along with it?

I don't want to sweep everything away. My background is in music. I have studied Bach; I played the clarinet growing up, did all my grades and things like that. I respect that kind of music, too. It's just, I'm interested in new music, right?

HS You've got to know the rules before you can break the rules.

ST Maybe. Or maybe not knowing the rules is a good starting point as well. So you can just do what you want. Maybe there's no boundaries or any kind of preconceived ideas of well, I should make more music like this, or should modulate this way...

HS How did you get into electronics?

ST I first got into electronics when I was a girl, maybe about eight years old. My next-door neighbour at the time was into hacking and making and, in his front room, he had all his computer work out there. And he taught me to rebuild computers. So, as an eight-year-old, I was like, oh, wow, this is really cool. This is so cool. From then on, I built a home computer myself, out of components, and then when I was a teenager, I got into coding as a way of expressing yourself. Making your own website or making your own whatever page at the time.

I guess it's kind of always been a part of my life, working with technology or electronics. But it isn't until probably the last ten years that I started to study music technology. I thought, OK, this stuff has always been really exciting to me, this way of working and this way of thinking. So why not bring it in to my music-making?

So, I started tinkering and started thinking about how I could build a circuit, using things like the 555 timer. That's like a repertoire piece among instrument builders. And then yeah, I guess getting onto the harder stuff, Arduinos and thinking about how I could program that and what kind of music that these devices would allow.

Nowadays I use all sorts. I still work with a lot of analogue electronics. At the moment, I'm really keen on thinking about how these can be seen as a part of the kind of artwork itself. I'm looking at buying old components and stitching them in embroidery hoops and things like that, so you can actually see the electronics and see what's going on. I've done a lot of capacitive sensing projects with Arduinos – I love the LilyPad Arduino. It's great. It's super for textiles work because you can just stitch it onto fabric, or use crocodile clips to attach all sorts of crafty projects.

HS Do you ever use Raspberry Pi?

ST I'm learning, I'm learning. So I bought one, maybe two or three years ago, for an interactive installation project that I was working on. I thought, this is going to be great: this is going to allow it to be free of the computer. It's something that would definitely, for me, facilitate a lot more interactive work, which will be really good to just be able to leave something, like a yarn bomb that I've made interactive, and leave it up and running without my laptop.

My friend, he's a multimedia artist, Francesc Martí; he works with a lot of Raspberry Pis and little screens and a mix of audio-visual work. While he was doing his PhD with me at the Institute

for Sonic Creativity, he was teaching me how to use them, as a favour for redoing some software for him. So yeah, it's something that I really want to get into using.

HS I saw a circuit of yours that was embroidered onto fabric. Does that actually work?

ST Of course it works! This here is a 555 timer that's acting as an oscillator. And when you touch the conductive surface area, you're essentially completing the circuit. The harder you squeeze it, or the more you interact with this part, the more you can vary the pitch of the sound.

HS One final question for you: who else do you think we should be keeping an eye on in the field of DIY electronic music?

ST Oh, I can list a million people whose work I'm into at the moment. First is Lara Grant. She's based in America and she does a lot of work with textiles and soft modular synthesis systems. She's one of the organisers of an event called the eTextile Spring Break, which is kind of a research maker residency where we all get together and make and play stuff – I love what she's doing. Helen Leigh is an absolute superstar in the field, doing all sorts of wonderful projects. Locally to me in Leicester, there's Jim Fries – he does some wicked work with electronics. And if you haven't heard of her, I can strongly recommend you check out Afroditis Psarra – she's Greek, but she's based in Washington DC. Again, she does some really cool work with electronic textiles. She's another superstar in the field. She runs the DXARTS SoftLab at the University of Washington, where she's doing so much research into soft synthesisers and things like that. She's got some really cool projects. But there's too many to mention. That's what makes this field so fascinating – the sheer number of ideas that you see all around you. □

Below ⚡
A 555 timer makes
a great basis for
synth projects

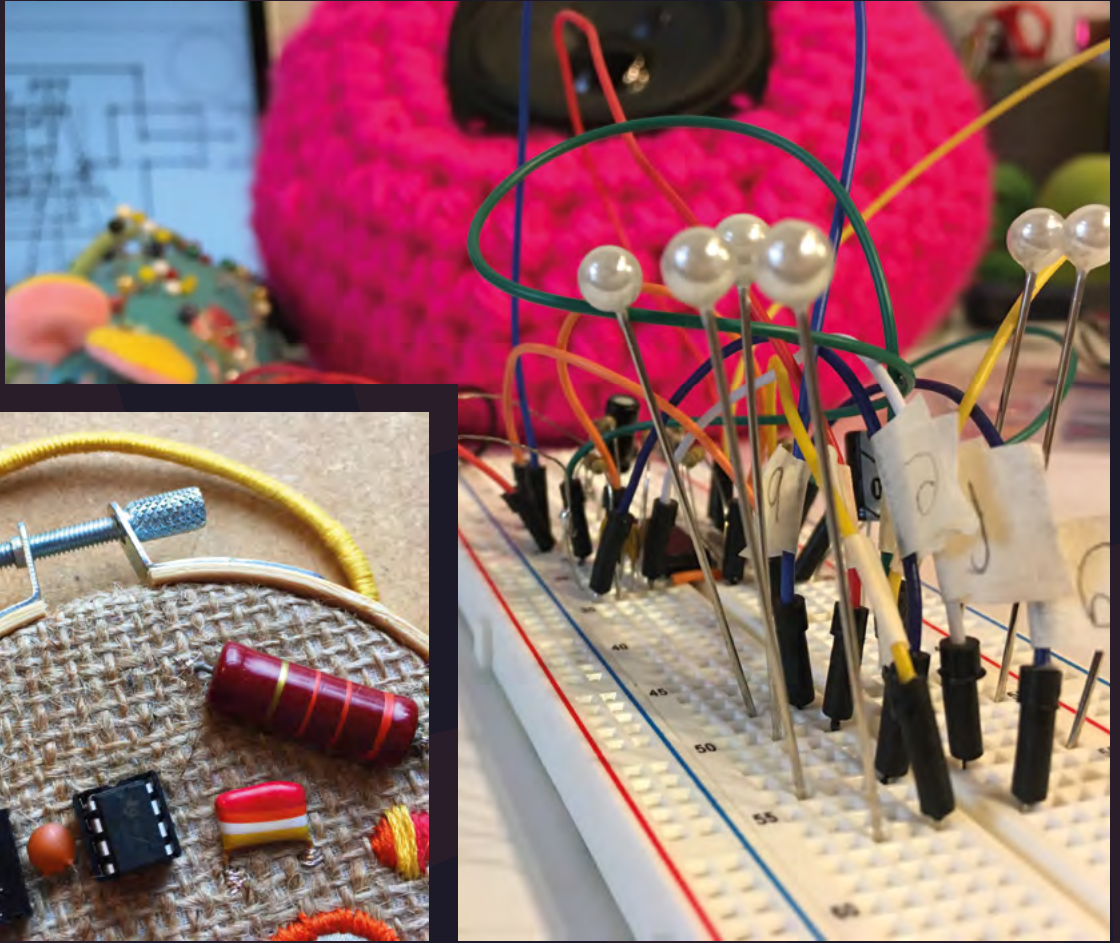

Left ⚡
This has to be the
easiest interface
yet: you squeeze
the pom-poms to
make sound and
vary the pitch



GLASS BOTTLES



Glass bottles are a cinch to reuse. Rosie Hattersley looks at new uses for old



Rosie Hattersley

[@RosieHattersley](#)

Rosie Hattersley writes tech, craft, and life hacks and tweets [@RosieHattersley](#).

Fill 'em up and start again is the most obvious way to reuse empty glass bottles, but there's probably a limit to how many you can make use of so easily.

While glass is an uncontentious item to put in your recycling bin, reusing what you've already got is an even better approach if it means you then don't buy something new.

Practical options here include using glass bottles as indoor planters, upcycling them as striking lamp bases or pendant lights, or simply half-filling one with water and using it as a vase. But since HackSpace readers are rarely content with something so straightforward, we've tracked down some more creative ways to make use of sturdy glass repositories.

Glass, of course, is made from molten sand and has been around for several millennia, with artefacts

successfully cool glass, so that it retains its strength, include a process known as annealing, which involves the use of gradual temperature reduction chambers. These more robust forms of glass bottle also make them more suitable for reuse, and able to withstand cutting tools without fracturing.

If you are keen on the idea of upcycling some bottles, knowing how to safely cut glass will be an invaluable skill. Helpfully, there's an Instructable explaining how to cut through glass bottles in a fairly low-tech and safe way:

[hsmag.cc/GlassBottleCutter](https://www.hsmag.cc/GlassBottleCutter).

Once you've cut your bottles, they can easily – and effectively – be given a new lease of life as drinks tumblers (as long as you've first smoothed the cut edges, of course) or, as in this selection from BensBottleUpcycling, as candles:

[hsmag.cc/BensBottles](https://www.hsmag.cc/BensBottles).

We also love the idea of creating an automatic bird feeder in which the bottleneck prevents all the seeds spilling out onto the bird table. Lots of examples can be found online such as [hsmag.cc/BottleBirdFeeders](https://www.hsmag.cc/BottleBirdFeeders), and the step-by-step guide provided by Birdy Official is a handy resource:

[hsmag.cc/BirdyOfficial](https://www.hsmag.cc/BirdyOfficial).

For an elegant option that is decorative as well practical, use a coloured glass bottle and bend lengths of copper around the bottle's form. The copper coils are also used to suspend the upended bottle from the branch of a tree once it's been filled with nuts and seeds.

"IF YOU'RE KEEN ON THE IDEA OF UPCYCLING SOME BOTTLES, KNOWING HOW TO SAFELY CUT GLASS WILL BE INVALUABLE"

from Southeast Asia showing its use at least 2300 years ago. Early examples were thinner and more brittle than the bottles we can produce these days, thanks to the availability of much hotter furnaces and moulds. Advances in our understanding of how to

RECYCLED BOTTLE TABLE AND STOOL

It lacks the elegance of the commercial creations we've just mentioned, but for sheer inventiveness, we had to include this amazing make which conjures usable furniture from almost nothing

more than sand, some old bottles, and a tyre. Once packed in tightly to a sand and cement former, the beer bottles seemingly all but disappear as the

table and stool begin to take shape, the latter with a leg conjured up from a drainpipe former. In fact, the first 13 bottles, plus a further eight added later, will become an integral part of the tabletop and come into their own after dark. Once the two pieces have been painted, the final twist in the innovative upcycling project sees the table and stool pimped with lights and flash through the beer bottles' glass bases. →

Project Maker
CEMENT
CRAFT IDEAS

Project Link
hsmag.cc/TableAndStool

Left ♦
Glass plus LEDs
can create some
stunning effects



BOTTLE LAMP-STAND

Project Maker
EMMA'S LETTERS

Project Link
hsmag.cc/SkullsLamp

Whether you keep the label and add a light and additional external decoration, or cover up the outside with paint or other materials, prettying up an old bottle can be an easy creative project for a child, or a more artistic endeavour.

Maker site Etsy is chock-full of beautiful lamp-stands and chandeliers made from repurposed glass

bottles – an idea that was in vogue during the early to mid-1970s, but without the level of panache some of these modern makers display. If the bottle you're reusing has an attractive label, it makes sense to retain it as part of the design, as per the gorgeous selection showcased by Etsy seller Emma. Choose a bottle with an interesting shape, or spray or embellish it to add character, then pair with an eye-catching shade. Clusters of LEDs inside are a popular inclusion too.



Right ♦
Step 1. Empty the bottle. Mmmmm

Credit
Emma's Letters

GLASS BOTTLE INSTRUMENTS

The song *Ten Green Bottles* clearly describes sitting targets just waiting for someone to take aim at them, but if you have an array of empty bottles, you could do worse than use them to create some tunes of your own. You'll

get eco-entertainment simply by turning them into wind chimes. Among the more whimsical musical instrument ideas is this one for a kazoo, which involves using a candle-flame to heat up the glass near the neck to make it easier and safer to remove. You also need to remove the bottle's base



and, once the edges have been sanded, glue a snugly fitting plastic cap in place with holes cut out for different notes.

Blue Peter and Bill Bailey have both been ambassadors for glass bottles as musical instruments, demonstrating how blowing across the rim of a bottle top produces a musical note, with differing notes

resulting from different bottle sizes or amounts of water in each. Lashed together they serve a turn as glockenspiels too. Or, you could just enjoy a remote-control car playing the Mario theme tune on a line of glass bottles: hsmag.cc/MarioSong.

Project Maker
JAMES
MCGEEHEE

Project Link
hsmag.cc/GlassKazoo

Left ♦
Rzzzz Rzzzz
RRRRRRRZZZZZZ
RZZZZ

BOTTLE FOLLY

Bottle walls can be both decorative and practical, breaking up the monotony of cement and allowing sunlight to stream through. Southwest USA has

dozens of examples of Earthship homes built using bottle bricks (details of how to make such 'bricks' are here: hsmag.cc/BottleWalls), while Thai monks took things a step further: the 20 buildings of the Wat Lan Kuad have walls and sculptures made from hundreds of Chang and Heineken beer bottles. For a bottle building that you can actually visit, British retiree Richard Pim spent several years repurposing 5000 of his own and friends' empty wine bottles in order to create the dome-shaped Bottle Folly (aka the Blotto Grotto) in his gardens in Pembridge, Herefordshire. He told industry magazine *The Drinks Business* of the 5m wide, 3m tall room: "Some parts

of the glass hemisphere directly face the sun at all times of the day, giving an extraordinary sparkle which is reflected in an interior pool". Richard recently sold Westonbury Mill Water Gardens, but its new owners have vowed to keep the garden and its three follies for the public to enjoy.



Project Maker
RICHARD PIM

Project Link
hsmag.cc/BottleFollies

Below ♦
Why do modern houses never have follies?

Credit
Richard Haworth





The
MagPi

HackSpace
TECHNOLOGY IN YOUR HANDS

CUSTOMPC

3 ISSUES FOR £10



FREE BOOK



hsmag.cc/hsbook

Subscribe to The MagPi, HackSpace magazine, or Custom PC. Your first three issues for £10, then our great value rolling subscription afterwards. Includes a free voucher for one of five fantastic books at store.rpiexpress.com/collections/latest-bookazines
UK only. Free delivery on everything.

FORGE

HACK | MAKE | BUILD | CREATE

Improve your skills, learn something new, or just have fun tinkering – we hope you enjoy these hand-picked projects

PG
70

LOCK PICKING

Create your own
lock picking tools

PG
76

DIY TABLET



Turn Raspberry Pi into
a portable computer

PG
80

FREECAD

Design 3D objects directly
from photographs

PG
86

STEREO PHOTOGRAPHY

Like photos but in
the third dimension

PG
64

SCHOOL OF MAKING

Start your journey to craftsmanship
with these essential skills

64 Compressors



PG
94

MIDI CRACKERS



Control a Pure Data synth
using Raspberry Pi Pico



Working under pressure

Using compressed air in the workshop



Dr Andrew Lewis

Dr Andrew Lewis is a specialist fabricator and maker, and is the owner of the Andrew Lewis Workshop.

There's a particular sound to a working garage. Ratcheting noises, the clink of spanners, and the unmistakable hiss of air as impact wrenches and die grinders are connected or disconnected to a compressor. It's a sound that's not heard very often in the home workshop, but compressed air tools can be an excellent addition to every maker's arsenal. In this article, you'll learn how compressors work, their strengths and weaknesses, and how to look after the compressor in your workshop.

Compressors might seem a bit old-fashioned to some people, given that they essentially exploit a similar technology to steam-engines. This idea couldn't be further from the truth, and there are multiple advantages to compressed air in the workshop. Compressing air into a tank is

a great way to store energy. It's cheap, doesn't involve environmentally damaging chemicals, and transferring compressed air through hoses is a lossless process. Because the source of motive force is stored in a tank outside of the hand tool, air-powered tools tend to be lighter and more powerful than their battery equivalents. Air tools also offer no chance of electrocution, and less chance of spark generation in difficult work environments. Dust and other contaminants are blown away from air tools, rather than being sucked into the cooling vents or air intakes of electrical and petrol/diesel tooling.

This paints a very rosy picture of compressed air tools. If they're so good, why aren't they flying off the middle aisle of the supermarkets and into every home workshop? The advantages listed above are balanced by a set of disadvantages that limit the situations where air tools are practical. Most obviously,



the compressor is a large tank of high-pressure gas, and there are risks and maintenance requirements associated with that. If a battery fails in an 8-volt power tool, it might, under certain circumstances, start a small fire. If the safety valve or storage tank fails on a compressor, it will probably demolish the building that it's in. If you aren't competent and diligent while working with pressure vessels, they can kill or maim you in very loud and spectacular ways. Another disadvantage is that the motor on a normal compressor is loud, typically around 80dB. Reducing this level of noise is prohibitively expensive for the normal user.



If they're so good, why aren't they flying off the middle aisle of the supermarkets?



Let's take a look at the gross anatomy of a compressor. At the highest level, a general-purpose compressor will have some form of compression apparatus and a motor that drives it, an air storage tank, safety valves, a pressure switch, and air outlets. The basic operation of these parts is not complicated, although several different technologies might be used to accomplish those operations.

There are a number of specialist technologies that only apply to large industrial compression systems, but they aren't found on domestic grade machines, so we won't concern ourselves with those in this article. →

Above ♦ This small compressor is fine for airbrushing and running low-duty tools like an air nailer or tyre-inflator. With a small tank and a low-powered, single-piston compressor, it's less useful for angle grinders or other tools that run for more than a few seconds at a time



Above

Pressure can be measured in different units. Make sure you understand what the numbers mean before hooking up your compressor

QUICK TIP

Different air tools work at different pressures. The correct pressure rating is normally stamped or printed on the tool. Set the regulated output of your compressor to match the tool before you connect it.

The compression head will typically be either a reciprocating or a rotary head. Reciprocating heads use one or more pistons to compress air into the storage tank. You can think of this mechanism as a very heavy duty bicycle pump, or a balloon inflator. These heads are found on the cheapest type of compressor, and are ideal for home use. Reciprocating heads are oil-cooled and have a duty cycle of around 30–50%, meaning that they are best suited to intermittent use, such as running a hand tool for short periods of time. The piston type of compressor is a well-established technology. It is robust and can cope with working in a dirty environment without too much trouble. It's also a simple mechanism that can be maintained without specialised tooling. However, the reciprocating head does need more overall maintenance, and will wear out eventually (after several years in normal home use). Rotary head compressors are a more modern design that uses precisely aligned counter-

rotating screws to compress the air into the tank. Unlike reciprocating compressors, the rotary screw compressor is more efficient and has a 100% duty cycle, which means that it can run constantly without overheating. The rotary screw is also quieter, but the precision of the mechanism means that it is more complicated to maintain and is less robust than a reciprocating piston compressor. Rotary screw compressors are more expensive, and geared towards constant use in cleaner environments. A paint shop and spray booth would be a good example of where the rotary screw would be a good choice for a compressor.

The motor driving the compression head is something you'll need to pay attention to if you're buying a new compressor. Assuming that you'll be

Rotary screw compressors are more expensive, and geared towards constant use in cleaner environments

using an electric motor rather than a petrol or diesel engine, you'll need to make sure that your motor is suitable for use on your electrical circuit. Some larger compressors use three-phase power, or use a higher amperage than a normal 13A socket can provide. You don't want to buy a compressor that blows your circuit-breaker if it switches on while you're boiling the kettle. The connection between the compression head and the motor is also important. Direct drive motors connect directly to the compression head,

SAFETY CHECKS

Before you start using a compressor, you need to do some basic safety checks. First, check for signs of obvious damage. If there are any dents, rust patches, cracks, or punctures, stop and get the item repaired or replaced. Check that the dials are working, and that the quick-release fittings are closed and free from debris. Check the oil level, check that the air pressure in the reservoir isn't too high, and keep watch while the compressor fills the tank to make sure that the pressure switch turns off the motor when it should. Avoid direct skin contact with high-pressure air. It might seem innocuous, but high-pressure air injuries can be devastating, and can even result in amputation or death. Always wear appropriate PPE when working with compressed air.

NOISE REDUCTION

Noise is a common issue with compressors, and there are a few things you can do to try and minimise the nuisance. Putting the compressor further away is a common solution, but in the suburban setting, you might find it difficult to site your compressor in a place where everyone is happy. Building a sound-proof box is another common solution, and this works quite well. Any dense, heavy materials will help absorb sound from the compressor. Just remember that you need sufficient airflow to fill and cool the compressor. Adding a larger baffle to the air intake of the compressor will help reduce noise levels, as will moving the intake further away. Decoupling the motor with rubber washers can reduce vibration, and anti-vibration rubber matting does an excellent job of reducing transferred vibration from the feet of the compressor.



and are more efficient, but they are also noisier in operation. Belt drives use pulleys and belts to connect to the compression head, and are quieter because less vibration is transferred through the belt. However, belts can slip and stretch over time, and will eventually need to be replaced.

The compression head and the motor are usually mounted onto the reservoir. The air reservoir is just a pressure vessel with an inlet, an outlet, and a drain.

The drain is mounted on the bottom of the tank, and is used to clear out any condensed water. You should empty the air reservoir and check this valve regularly. The inlet of the tank connects to the compression head, and the outlet attaches to the regulator, pressure gauges, safety valves, hose connectors, and pressure switch. The pressure switch is usually adjustable and controls when the motor switches on and off. If the pressure switch fails, it's possible for the compressor →

Above ♦ This compressor has a well-sized tank and a dual piston compressor with a powerful motor. It's heavier, louder, and less portable than the small supermarket-branded compressor, but it can produce enough power for prolonged use of sand-blasters, die grinders, power saws, and paint guns

Left ♦ You can see the pressure gauge, outlets, and red safety valve in this picture. You might notice that the red safety valve doesn't have a ring pull attached. New regulations recommend that these ring pulls are not used as they are often used to open the safety valve to drain the tank. This repeated misuse weakens the safety valve prematurely, so newer compressors and replacement valves won't have the ring pull





Above

There are a number of different competing standards for air hose fittings, some as small as 1/8", featuring a mix of male and female fittings with parallel or tapered threads, barbed connectors, push-fit connectors, and different bore sizes. If you keep a few different types to hand, you will have a much wider selection of the wrong type when you're connecting up a new tool

to keep running continuously even when the pressure in the tank is reaching dangerous (as in explosive) levels. The safety valve (usually a small red valve, sometimes with a ring pull on it) will blow in this eventuality and bleed off the excess pressure. It's important never to mess with the operation of the

COMPRESSOR STATS

There are three numbers that are important when you're looking at a compressor: horsepower; cubic feet per minute (CFM); and capacity in litres. Horsepower is the power of the motor, and this is important because it relates to how much power you'll be using to recharge the compressor. The CFM shows how quickly the compression head can compress air when it's running. More CFM means less time to refill the tank, and more power that you can use for tools like grinders and sand-blasting kits. The capacity of the tank in litres tells you how much reserve air you'll be able to store in one go. Small tanks around 25 litres are fine for some light airbrushing or firing the odd nail into some wood, but you'll find yourself waiting for your compressor to refill the tank if you do much more than this. Larger tanks give you more time to work without the compressor running, which can be useful in a domestic setting where you don't want to run the compressor after a certain time of day to avoid disturbing the neighbours. If you have a 100-litre tank, you can carry on working with your tools for some time, even if the compressor is switched off.

It's important to set an appropriate pressure and connect your tools to the regulated output

safety valve, because dying a violent and painful death is not an effective use of workshop time.

On most compressors, the output will have a regulator valve, two quick-release connectors, and two gauges. One of the gauges will show the pressure in the tank, and the other will show the pressure that the regulator is set to. The regulator usually only connects to one of the outlets, and the other outlet is connected directly to the tank. It's important to set an appropriate pressure and connect your tools to the regulated output, or you might damage them.

Connecting your tool to a compressor should be easy, but in practice, this supposedly simple task is complicated by the sheer number of competing standards and hose fittings. In the UK, there are two main quick connector standards in use, and these are often referred to as PCL and Euro fittings. The PCL connector takes its name from the manufacturing company, Pneumatic Components Limited, which produces the connector. Confusingly,



Above ♦ Here you can see the size difference between a battery-powered die grinder and an air-powered grinder. The smaller grinder is easier to handle, lighter, and faster than the battery version

MAINTENANCE

A compressor and air tools need regular maintenance to perform properly. Tools should be kept lubricated with a spot of silicone oil on their oiling ports (usually the air inlet) every time they are used. Make sure that quick connector fittings are similarly treated with oil, and any worn or damaged O-rings or seals are replaced as soon as they are spotted. Check the oil level in the compressor regularly, and change the oil as directed in your operator manual. Empty and drain the reservoir regularly to make sure no water builds up inside the tank, and use oil and moisture traps in your air-lines to protect sensitive tools like spray-guns. Check that the pressure switch is operating properly, and adjust it if necessary. Check that the emergency stop button works, and that the cables show no signs of overheating. If you are going to be leaving the compressor for any length of time, switch it off and de-pressurise the tank.

PCL also produces the Euro fitting, which is more properly called a PCL XF connector. The PCL XF has a larger bore for more power-hungry tools. There are other standards of connector out there (such as Schrader couplings and Automotive types), but they're less popular in the UK and Europe. You can either buy an air hose with these fittings already attached, buy a standard hose with a BSP fitting and fit adapters to them, or buy barbed PCL or Euro connectors and fit them directly to a length of air hose with hose clips. If you need to fit a particular connector to a tool, then you'll find that most tools use a 1/4" BSP fitting with either a straight or tapered thread. If you are connecting to a tool that's likely to vibrate (like a reciprocating saw or an air hammer), then you should use a short, flexible whip hose between the tool and the connector. These hoses are fitted to stop vibration from the hand tool propagating into the hose connector and wearing it out prematurely and are recommended by the Health and Safety Executive in the UK. For the home workshop, it's likely that all of the compressor hoses you'll use will have 1/4" BSP fittings, but it's possible you'll encounter larger connectors on some tools. Some cheap import tools also have metric threaded fittings, and adapting them to work with different connectors can be difficult. It is possible to make adapter hoses with different fittings to switch between connector types, but it's best to just pick one standard and stick to it if you can.

There is a wide range of air tools available for you to use. The most useful tools will vary depending on your own personal needs, but some air tools

really transcend maker styles and are worth special mentions. Air-powered nail guns and staplers are excellent, and should be in everybody's air tool collection, as should a die grinder and a body saw. The air duster is reason enough to buy a compressor on its own, and an air nibbler makes cutting through sheet metal a breeze. If you have a laser cutter, attaching a compressor to your air assist will work wonders for the cleanliness of your cut edges. ▣

Below ♦ Air tools are easy to get hold of, and are typically much cheaper, lighter, more powerful, and tougher than the battery or mains version of the same tool



WARNING

Locksport is the practice of picking locks that you own. Using these tools and techniques on locks you don't own may be illegal. You should be aware of the laws and regulations on owning lock picking tools in your country

Lock picking, DIY tool time!

Nothing feels quite as good as picking a lock using tools that you made yourself. Building on last month's guide to lock picking, let's make some tools and accessories to increase your locksport capabilities



Jo Hinchliffe

 @concreted0g

Jo Hinchliffe is a constant tinkerer and is passionate about all things DIY. He loves designing and scratch-building both model and high-power rockets, and releases the designs and components as open-source. He also has a shed full of lathes and milling machines and CNC kit!

Making your own tools for locksport is great for many reasons, but there's two that stand out. Firstly, it is incredibly satisfying to open a lock using homemade tools. Secondly, you

can make a specific tool for a specific lock that might not be available to purchase. Finally, this is a cheap activity; many manual tools can be made on a budget, which means you can learn and experiment for very little cost.

Let's look first at making some tension wrenches. There are actually lots of designs for pin tumbler tensioning tools, but the two most common are the flat-style ones cut from a thin sheet of metal, or the bent and twisted ones formed from a thin metal strip.

To make a small, flat tension wrench, we can use a small piece of a hacksaw blade. Hacksaw blades are a good choice as they are often of reasonable quality steel, are about the right thickness for many locksport tools, and are pretty cheap to buy or replace. Be careful when handling them as they are obviously designed to cut things. There are numerous ways to mark out a design on a hacksaw blade: you can make a card template and draw around it, you can colour the blade with permanent marker and then use a metal scribe to draw your wrench, or you can simply draw the wrench shape onto the hacksaw blade using a fine-tipped marker and a ruler. Dimensions are not massively critical, but you need to make the part intended to fit into the lock small enough to fit – we went with around 3mm wide and pretty much the full width of the hacksaw blade for ours. For the length of the tension tool, we went with roughly 80mm, but feel free to adjust this as you feel necessary (**Figure 1**).

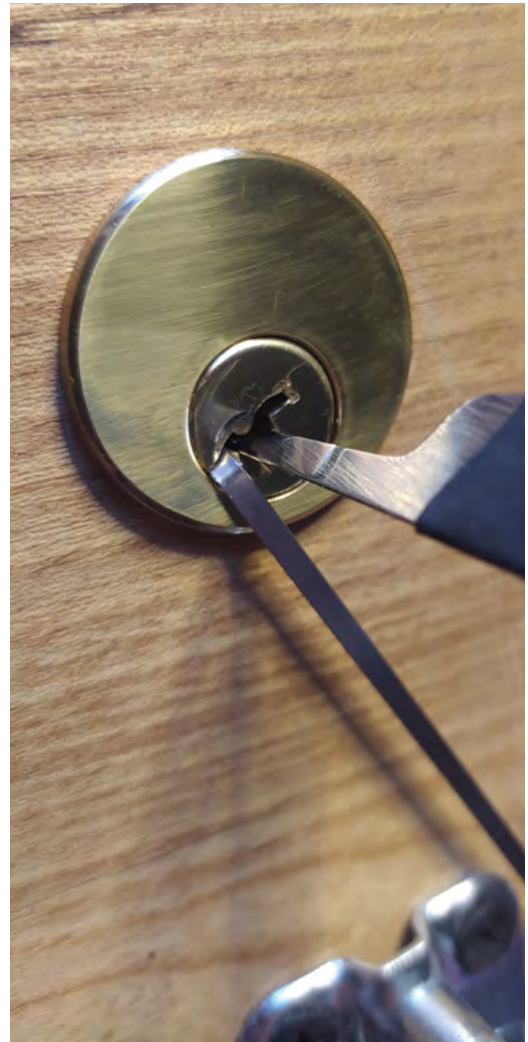

Right  Using the DIY half-diamond lock pick and the windscreen wiper tension wrench to open a pin tumbler lock held in our practice board



Figure 2 ♦ This small stainless steel strip has been removed from a discarded windscreen wiper blade

We mainly used our rotary tool with a cut-off disc to cut away most of the material, but we also used our bench grinder for bringing larger areas to size – the bench grinder is easier to use in certain awkward corners. One thing you need to take care with when grinding tools is that the metal doesn't become too hot – this is important in terms of not burning yourself, but also it's about the metal not losing its tempered quality. If you overheat the hacksaw blade, it will lose its springiness and hardness and become less effective as a tool. Having a small tray of cool water next to your work area is great – you can dip the part into the water every few seconds to prevent it from overheating.

We ground out the bulk of the material with the rotary tool and then made final adjustments using the bench grinder. Having got our tension wrench to size, we can begin to clean it up. We tend to clean the paint off the hacksaw stock once we know our tool is ground to the correct shape, rather than investing more work into it before shaping, in case we make a mistake!

To clean up our flat-style tension wrench, we used a cordless drill with a sanding 'flap wheel' attachment to remove all the paint, and finally, we used some fine sandpaper to polish the wrench.

Whilst the flat wrench is great, the most common type of tension wrench is the 'straight wrench'. The straight wrench is a thin strip of steel simply bent at 90 degrees. The first challenge with this is often, 'where do I source a thin strip of steel?'. In DIY lock picking communities, there are two commonly discussed sources from which you can salvage thin strips of steel for all kinds of lock picking tools. The

“ We used a cordless drill with a sanding 'flap wheel' attachment to remove all the paint ”

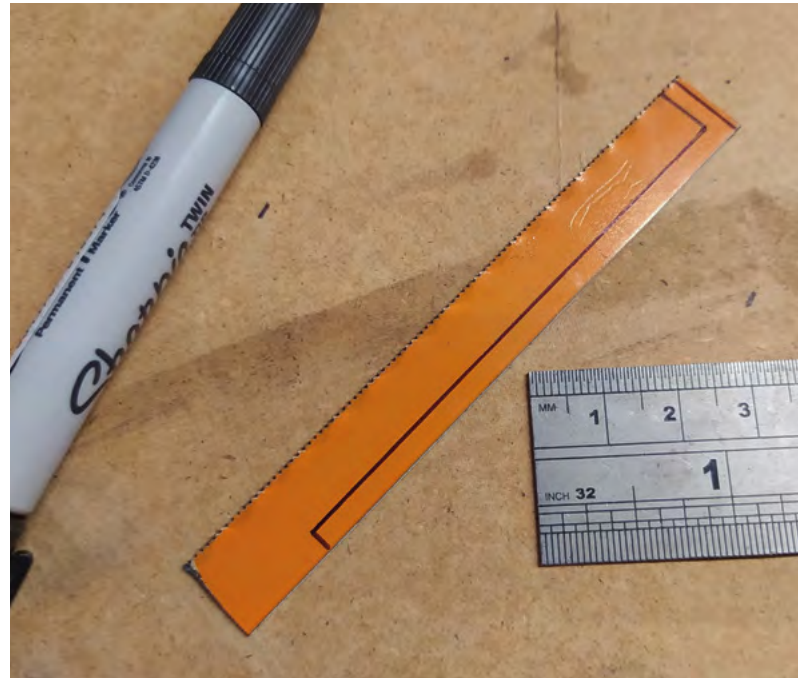

Figure 1 ♦ Using a thin permanent marker and a ruler to mark out our flat tension wrench design

first source is cast-off car windscreen wiper blades. Inside a windscreen wiper blade, there is commonly a metal strip running the length of the blade (**Figure 2**). When you swap your blades, peel the blade apart and retrieve the 3mm wide steel strip. It's quite decent stainless steel but can be a little brittle, so you need to make bend angles a little larger to avoid it breaking. The second source of superb steel for locksport tools is street-sweeper bristles (**Figure 3**). Street-sweeper vehicles have circular brushes filled with steel bristles

that rotate to brush debris out of gutters. Due to natural wear and tear, these brush heads tend to regularly drop bristles at the edge of the road as they clean, often at a frequency of one bristle every 15–20 metres. A walk

through a town, casting your eye into the gutter next to the pavement, will yield a few sweeper bristles, and over time, you can build up quite a stock of them! Don't worry if they are a bit rusty; they will polish up really well.

Using a sweeper bristle or a wiper insert, it is pretty straightforward to make a straight wrench. Simply create a 90-degree bend in the strip and cut to length. You can experiment with the length of the inserted section of the wrench. As a guide, the further the wrench slides into the lock, the more secure the wrench feels and maximises the feedback. However, the further a wrench enters a lock, the less room →

YOU'LL NEED

- ♦ Some hacksaw blades (used is fine!)
- ♦ Some street-sweeper bristles, or the innards of car windscreen wipers
- ♦ A bench grinder, or a hand-held rotary tool with grinding accessories
- ♦ Permanent marker and a ruler
- ♦ Some heat shrink
- ♦ Safety glasses
- ♦ Fine-grade sandpaper

TUTORIAL

Figure 3 ♦ Although it may seem a strange hobby, collecting broken street-sweeper bristles provides an excellent stock of materials for making a variety of locksport tools



there is for the pick to manoeuvre, which can make manipulating the rear pins more difficult. As a rule of thumb, most wrench makers and manufacturers would aim to have a wrench enter a lock no more than half the length of the lock cylinder barrel.

Making lock picks themselves is a similar process to how we made our flat-style wrench. Two of the materials we have used before, hacksaw blades and street-sweeper bristles, are very common in lock pick making. Again, there are no hard and fast rules about shape and design, but it is worth looking at and reading up on other makers' approaches, and it can be a good idea to start off with some tools made from pre-existing templates.

One of the most common lock picks is the half-diamond pick. It's often the first tool people pick up when trying to single-pin pick a new lock, and even if you end up using another pick on a particular tumbler lock, exploring the lock with a half-diamond allows you to feel each pin using the half-diamond as a probe.

A quick image search online for the terms 'lock pick template' revealed lots of results. Where possible, it's useful to find and download templates that have some kind of scale in them so that you can ensure any pattern you take from the template

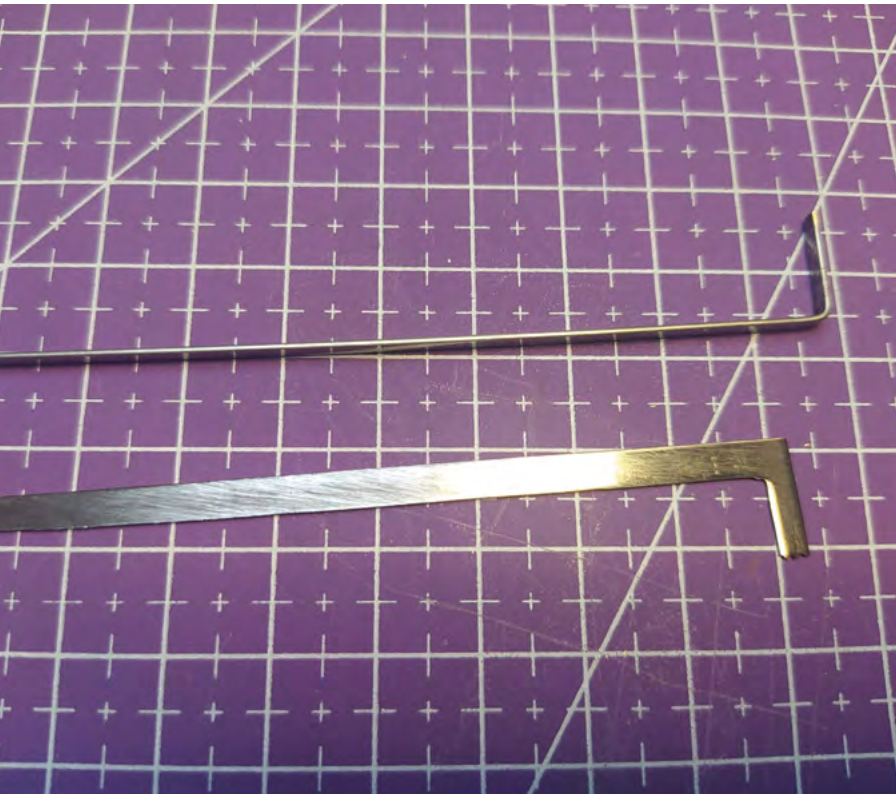

THERE'S A TWIST

Some tension wrenches feature a twist in the handle. This twist allows the wrench to be somewhat flexible and enables variable tension to be applied to a lock. The idea is that your hand pressure applies some tension, but the lock also resists that tension, and the twist allows the lock tension to counter-rotate force back into the wrench. This is useful in some more advanced cases when raking and picking locks. However, this twist in the wrench, in some way, acts as a vibration absorber and means that you will get reduced feel and feedback from the lock through the tension wrench. It's definitely advised to not use this type of wrench whilst learning and developing feel.



Above ♦ DIY tension wrenches ready for practice

Figure 4 ♦ A lock pick template image that we downloaded from many that can be found online

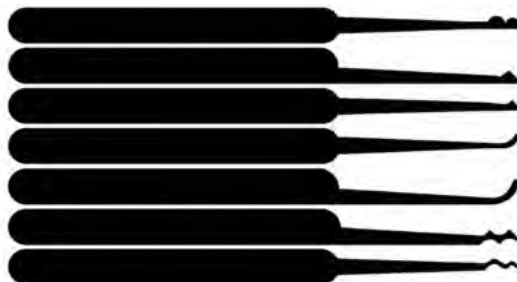



Figure 5 ♦ Again we used a thin permanent marker and a ruler to mark our design onto our hacksaw blade blank

QUICK TIP

We covered what these tools are and what they do in last month's issue!

is sized accurately. There are numerous ways to use these templates. In our case, they will simply inform a design we will draw on a hacksaw blade blank (Figure 5), but equally, you could print the templates, carefully cut them out, and glue them onto a hacksaw blank to give you a drawing to grind to. If you use that method, you can simply either wash or sand away the remaining paper off the blank once it's ground. We find that method a little tricky as you can't cool the work with water as you grind, and you have to work very slowly.

In Figure 4, you can see numerous designs, but we are going to take inspiration from the second pick from the top. This is a half-diamond, but notice that the bottom of the tool is completely flat. Whilst this slightly limits the range of motion within a lock compared to the more tapered half-diamond pick that is underneath it on the template, it does make this pick a good starter design as we need only grind the upper part of the tool tip.

We marked our design onto a hacksaw blade using a fine-tipped permanent marker. We made the tool tip length around 45mm (the length from the tool handle to the end of the half-diamond tip). We made the point at which the tool tip joined the handle around 4mm high. We then carefully ground out the design using the combination of the bench grinding wheel and the rotary tool. Again, similar to when we made the flat wrench, we then



Above ♦ Our small collection of completed tools: two tension wrenches, a half-diamond pick, and a double-ended 'Bogota'-inspired rake

cleaned the paint off the freshly ground lock pick, and we also ground back the handle section to remove the hacksaw blade cutting edge.

It's important with both wrenches and lock picks that they are as smooth and polished as they can be before use in a lock. Lock-pick tools are generally

harder than the brass or alloy materials that pin tumbler locks are made from and they will leave marks and create wear in the lock. Apart from being very telling for lock forensics experts this wear and tear introduces tiny metal particles into

the mechanisms causing further wear. Lock picks should have no sharp edges and so we tend to use a range of emery cloths to smooth out all the edges and then move through towards very fine grades to polish our lock picks as best we can.

Last month, we looked at both single-pin picking and also raking pin tumbler locks so we wanted to →

It's important with both wrenches and lock picks that they are as smooth and polished as they can be

QUICK TIP

With all locksport tools, there are no rules, using pre-existing design ideas is usually a good starting point, but do experiment and find out what works for you.

TUTORIAL



Left ◆ Bogota rakes made from sweeper bristles are relatively easy to make using a small file instead of grinding tools if they aren't available

Each of the two tools can be used as a tension wrench using the non-pick end

GET A GRIP

Often people want to put handles on their lock pick tool creations, and there are numerous pros and cons. You can find examples online of beautiful tools with ornate handles which are a credit to the creators. You can also find examples of tools that would work excellently with no handles, and tools with handle sections that have been crudely finished when compared to the tool end. When learning to lock pick, it's a good idea to not have any handle material at all on your lock picks and wrenches. Any handle material attached to your tool will reduce or dampen any movements in the lock being transmitted to your fingers, which makes lock picking harder to achieve. When you develop some feel for lock picking, you might want to add handle material to increase the grip on a tool, or even just to stop tools jangling and rattling when they're in storage. A great, cheap starter handle material is heat shrink, which you slip over the tool and then use heat from a heat gun, soldering iron, or even a lighter to shrink over the tool. You might also want to play with creating ergonomic grips using products like polymorph or Sugru. Further down the line, you might want to create 3D-printed handles, or handles made from exotic wood, fibreglass, and leather. You are only limited by your imagination.



make some kind of raking tool. There's a classic pair of rake tools called 'Bogota' rakes – you can find clear instructions for the original design in the DIY tools section of lockpicking101.com, including dimensions and spacings for the wave-shaped tool tips. The original, excellent design uses two street-sweeper bristles bent into a couple of angles – each of the two tools can be used as a tension wrench using the non-pick end. The original design also makes use of a small spring and a safety pin to make these tools a 'stealth carry' option, pinning them to the inside of a jacket. Again, rules vary on this across the world, but here in the UK, it would be problematic to justify why you ever needed to conceal lock picking equipment about your person!

As we don't want to conceal our Bogota rakes, we will change the design to make a handy two-in-one raking tool. We are going to use a street-sweeper bristle, but we'll keep the bristle straight and cut the rake tools into each end. We can, of course, use the same tools – the grinder and the rotary tool – to make the Bogota-style rake, but as there is a lot less material to remove compared to a hacksaw blade, we opted to use a small file to create the shapes in the bristle.

Again, once we finished roughing out the tool, we spent some time polishing and smoothing the lock pick to allow it to move cleanly in the lock. This is particularly important with rake tools as they tend to be moved more vigorously in and out of a keyway.

As you improve your feel and begin to open locks using single-pin and raking lock picking approaches, you might notice that, if you are working with the lock in hand, you get feedback through the hand holding the lock. This is perhaps useful as a beginner, but really, you want to try and only rely on feedback that comes back through the tools into your hand. The ultimate goal is to manipulate a lock installed, as designed, in a door or other solid structure. A good solution for this is to make a practice board. A practice board is a simple project where you

essentially install a lock in a block of wood – this means you have to pick the lock with the lock in a position where you can't hold it. If your practice lock happens to be one you found in a door in a skip or junk pile, you may consider just cutting a chunk out of the scrap door.

If you have a collection of locks, you can mount multiple locks on one practice board, but for a simple, small practice board project, we opted to make a board that had one pin tumbler lock installed, as well as a shackle to which we can attach a padlock (**Figure 6**). We cut a piece of 30mm thick timber into a rectangle roughly 15 cm by 20 cm. Our five-pin tumbler lock required a 28mm hole to mount through, and we drilled this using a spade drill bit. We don't want to mount the back of the lock particularly (the latch mechanism that would be fitted to the inside of a door), and we also wanted to be able to remove our lock quickly so that we can 'repin' it. Repinning is where we disassemble the lock and change the pin sequence for a new challenge. Many of this style of pin tumbler lock have M5-threaded mount holes, and we replaced the original fittings with two M5 bolts and some simple 3D-printed cylinders that act as oversize washers to firmly clamp the lock into position (**Figure 7**).

CHALLENGE YOURSELF

Repinning a lock is essentially disassembling a lock and changing the order of the pins inside. This is a complex subject which we aren't going to cover in detail here, but it's useful to know that if you have a lock that isn't a challenge anymore, you could create a new puzzle just by repinning the lock. You can challenge yourself further by replacing pins with special security pins that are harder to pick. There are lots of guides online, and it's worth reading a few before you attempt this task – it's easy to get it wrong and end up with a scattered collection of pins! Repinning locks means that a practice board with just one lock installed can actually be used to create a great variety of locksport challenges.



We added a small block of wood to the base of our practice board; this block of wood allows the board to stand up unaided. However, we found that unless you make a large, heavy base, your practice board will move around on a desk when in use. Using the added small block, we tend to use our practice board either clamped to the edge of a desk using a small G-clamp, or the block is small enough to grip the entire practice board base in a small, desk-mounted vice.

To finish off our practice board, we sanded all the edges smooth and added the padlock shackle. In use, it works very well and is small enough to be packed away easily.

The tools and the practice board we have made are enough to provide many hours of lock picking practice, but it's definitely fun to add to your DIY tool arsenal and explore how different lock picks can be used. We hope you have enjoyed this two-part exploration of this fascinating hobby, and feel free to send in any images of lock picking tools you may have been inspired to make! □



QUICK TIP

It's a good idea to polish the working ends of tools with fine-grade sandpaper to reduce wear inside your practice locks.

Figure 6 □
A wooden practice board allows you to work on a lock in its correct orientation without feeling any of the lock's components. It can add a new dimension to your practice

Figure 7 ♦
The back of our practice board showing our printed lock clamping system

Build an Android tablet with Raspberry Pi



Rob Zwetsloot

Rob is amazing. He's also the Features Editor of *The MagPi*, a hobbyist maker, cosplayer, comic book writer, and extremely modest.

magpi.cc

Top Tip

Installer issues

Run the installer as Administrator if you're having issues, and check if the SD card runs, even if the final checks fail.

Emteria.OS is a version of Android for Raspberry Pi. Let's use it in its natural, portable environment, and use it for development

Android on Raspberry Pi has been a topic of discussion for years in specific spaces, and while there have been attempts in the past to port Android, emteria.OS has been the best way to use Android on Raspberry Pi for a few years now. With some recent great updates, we're revisiting this great OS to get it working as an Android tablet, and see how it can be used for Android dev.

01 Raspberry Pi hardware

You'll need a Raspberry Pi 4 for this project so that you can make the most out of your custom tablet, although you can use a Raspberry Pi 3B+, Raspberry Pi 400, and Compute Module 3 with emteria. Emteria also supports HDMI on Raspberry Pi so you can connect it to a monitor, TV, or other kind of small display depending on if you want to use it as a tablet for development.

With an official touchscreen, you can cut down on some wires and have it work in a traditional Android way.

02 Build your tablet - part 1

To make sure everything is working before fully committing to our build, we suggest just connecting Raspberry Pi 4 to the display at first. You may need to construct your screen, however that is quite simple and there are full instructions here: magpi.cc/screenbuild.

You do not need to add the jumper wires between the control board and Raspberry Pi though, as you will need to power Raspberry Pi and the display separately. You can use the special USB splitter cable that came with the SmartiPi Touch 2 case if you wish to make it easier down the road, however you will at least need a micro USB power supply and a USB C power supply.

03 emteria.OS Installer

You'll need to create an account for emteria. OS, which you can do at emteria.com. Once you've done that, you can head to the download page at magpi.cc/emteriainstaller and download the installer. Run the program once it's downloaded to



Emteria is a version of Android that can run on Raspberry Pi and other hardware

Using a touchscreen and case, you can create your own Android tablet using emteria

You'll Need

- Raspberry Pi 4
- Raspberry Pi Official Touchscreen Display magpi.cc/officialdisplay
- SmartPi 2 Touch Case magpi.cc/smartipiz
- emteria.OS emteria.com
- Mobile battery

install – you may need to tell Windows to ‘run the software anyway’ if a warning window pops up.

Once this is done, open the Emteria installer app, and you will be asked to login using the account details you created earlier. From there, select your hardware (Raspberry Pi 4), choose the right SD card if you have multiple plugged in, and then click flash for the installer to do its job.

04 Initial emteria.OS boot

Once the install has finished, plug your SD card into your Raspberry Pi connected to the touchscreen. Put the power in for the screen (the micro USB on the controller board), and then plug the power into Raspberry Pi 4.

It will cycle through the boot a few times before finally showing the emteria logo pulsing – after a while this will transition to a grey screen and do some set up before allowing you to click on next, where you’ll perform the classic Android setup.

05 Initial emteria.OS setup

The touchscreen will be working at this point, however you can always connect a mouse

and keyboard if you want to run through the process a little quicker. After setting your time zone time, and date, you then need to select your WiFi network to connect to. Once again, if you’ve used Android this should be familiar.

Now you need to activate your install (although you can test it out for eight hours before doing this). We logged in via our account, but you can enter a key if that’s easier for you. Skip the next two steps, agree to the EULA, and hit reboot for everything to be applied.

06 Build the tablet - part 2

If installation and setup went fine, you can install your Raspberry Pi and screen into the SmartPi case. Once again there is a handy build guide on how to do this: magpi.cc/smartipibuild.

At this point you can add a Raspberry Pi Camera Module to the whole case build, however at the

“ It will cycle through the boot a few times before finally showing the emteria logo ”

THE MAGPI



This tutorial is from in The MagPi, the official Raspberry Pi magazine. Each issue includes a huge variety of projects, tutorials, tips and tricks to help you get the most out of your Raspberry Pi. Find out more at magpi.cc

TUTORIAL



▲ Affixing Raspberry Pi to the back of the official touchscreen requires only screws and a DSI ribbon cable

time of writing it is not supported in the OS. The emteria team are working on it though, and some USB webcams are supported right now, so if you're desperate to take photos there are ways.

Top Tip

Sideload

Sideload is when you install an Android app from its standard APK file – you'll have to switch on a setting to allow installing apps this way though.

07 Install extra software

As emteria is not an official version of Android, you'll not have access to the standard Play Store. You can still sideload APK files if you download files to the device though, and there is F-Droid which is a free and open-source app store for Android. Opening up this app will prompt you to do an update before installing any apps, just like you would on the Play Store. You will have to allow it to install third-party apps from the system settings, which it will help you do.

08 Advanced settings

You've probably noticed that the tablet is currently set to landscape. With no gyro inside, you cannot automatically change the orientation. Bringing up the emteria settings allows you change the orientation to portrait (90 degrees), or even flip the entire screen over (180 degrees). You'll also notice there are a load of the developer settings sitting in here, such as keeping the screen awake (useful if you have it plugged into a power supply

for this stage), along with other settings for remote work, Ethernet connections, launching apps at boot, etc.

“ One of the great features of emteria is its ability to act as a kiosk ”

09 Other Android differences

While many parts of emteria work like stock Android, there are a few differences that are worth noting. First of all, as there is no dedicated off button on a Raspberry Pi, you'll find there is a shutdown app in the library that allows you to turn off, reboot, and head to recovery. The browser is not Chrome, and other default apps are swapped with non-Google based ones. You can still login to Google services using the browser though, and there are other browsers you can try as well.

10 Kiosk mode

One of the great features of emteria is its ability to act as a kiosk – a terminal with limited functions that you set yourself. It's meant for more

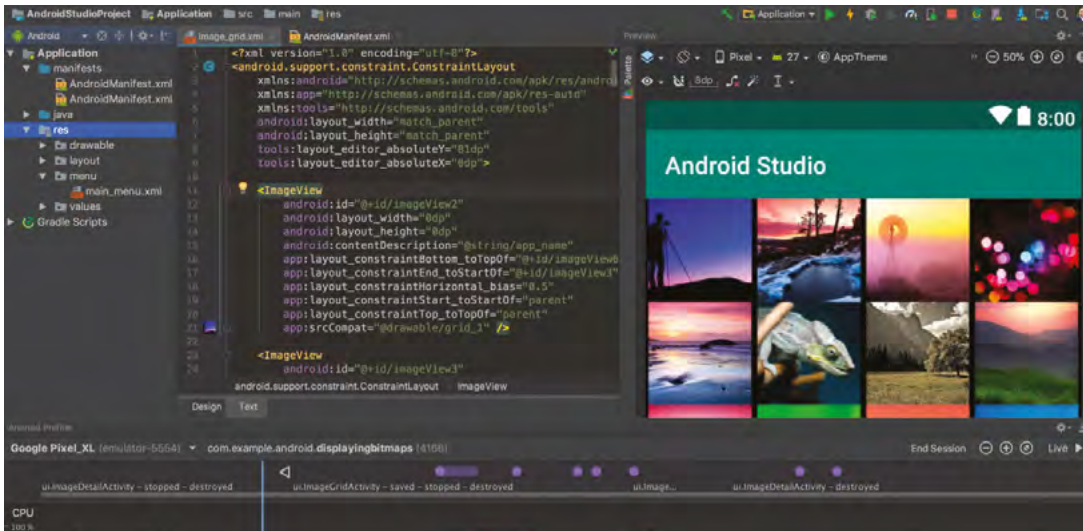

Android Studio is the development suite for Android apps

Choosing specific apps that can only be used in Kiosk mode can be great for kids or cafés

public places that might require people to sign up to a service, or get directions in a large area.

To turn it on, go to the emteria settings and toggle Kiosk state. Set a password so you can turn it back off, and then select Kiosk or Web launcher. In Kiosk launcher you can choose 'approved apps', which will be the only apps the users can use. Similarly, web launcher sets a selection of bookmarked websites that are the only ones that can be visited. Tapping ten times on the screen will bring back the Kiosk settings menu.

11 Portability

As well as a portable battery, taking a power supply with you can also work in case you stop in a place with power. SmartiPi Touch 2 also has a stand, making it easier to use on the go as well, however it does mean it's not quite as slim when folded up – the stand part can actually be removed with a screw to cut down on this size, making the whole thing a little easier to take with you.

12 Development tips

Emteria is based on the latest version of Android – Android 11 – making it a great development environment for Android apps. Even just connecting it to a monitor, or using the VNC functions, will allow you to test out apps you're creating.

Heading to developer.android.com will give you some great beginner tutorials and sample code on how to start, as well as the tools needed to build apps. [M](#)

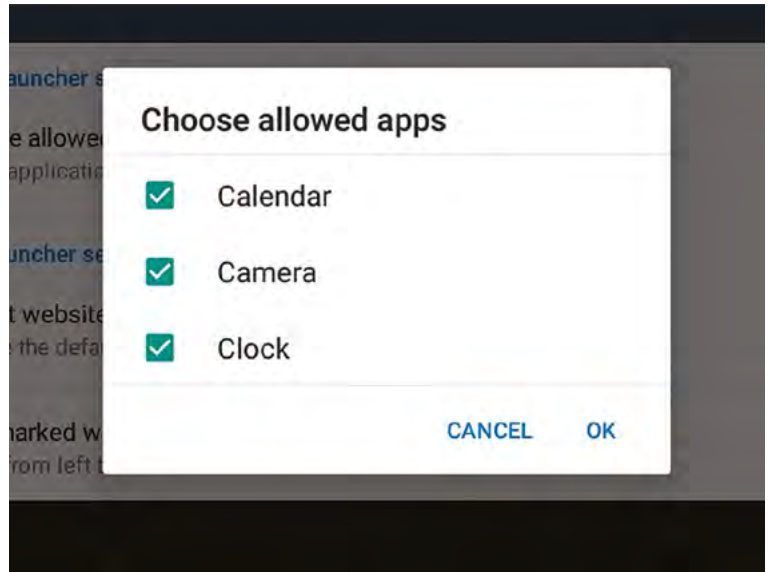

Emteria uses a specific program, much like Imager, to burn the latest version of the OS to an SD card

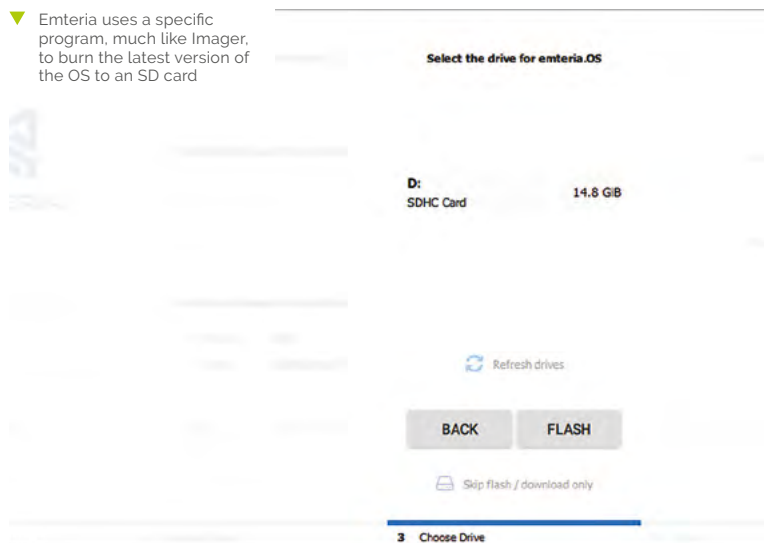

FreeCAD: intermediate sketching

Often a sketch is the foundation of a part, and we have only looked at the basics. Let's delve deeper into more intermediate features and approaches for sketching in FreeCAD



Jo Hinchliffe

[@concreted0g](#)

Jo Hinchliffe is a constant tinkerer and is passionate about all things DIY. He loves designing and scratch-building both model and high-power rockets, and releases the designs and components as open-source. He also has a shed full of lathes and milling machines and CNC kit!

Previously, in earlier parts of this series, we have looked at the basics of sketching in the Sketcher workbench and then occasionally looked at other Sketcher features, such as cloning and making multiples of objects (in issue 44). As such a fundamental approach to creating parts, it's certainly worth looking at in more depth.

To begin, let's revisit an approach we have used previously which we can use as an example. Open up FreeCAD and start a new project, move to the Part Design workbench, create a body, and then create a sketch in the XY plane.

In your new sketch, draw a rectangle using the 'Create a rectangle in the sketch' tool and don't worry about constraining it. Close the sketch and, back on the Part Design workbench, use the Pad function (on the 'Task' tab in the combo view window) to pad the

rectangle sketch into a larger cuboid. Next, select any face on the cuboid in the preview window and click the 'Add a sketch' tool to open a sketch that is attached to that face.

If we imagine that we want to add a hole to the upper right-hand corner of our selected face, and that we want the hole to be specifically placed with respect to the upper right-hand corner, this is slightly tricky. It's tricky, as the sketch underlying the cuboid object is unconstrained and we don't know its size or its position relative to the origin point. We have used a tool previously though that allows us to import underlying geometry and help us solve this issue. The tool we have used is the 'Create an edge linked to an external geometry' tool which, when selected, allows us to select underlying geometry objects, edges, and points, and make them selectable in the current sketch. So, to accurately place a hole positionally relative to the upper right-hand corner, we can simply select the right-hand edge of the cuboid and then, in turn, use that imported geometry to set horizontal and vertical distance constraints to the centre of our hole circle sketch (Figure 2).

In essence, what we have done in our hole, in a cuboid example, is use an underlying geometry to create a guide point in the new sketch onto which we can attach constraints. We can see, therefore, that guide points can be incredibly useful, but often we may need a guide point in a position where there is no underlying geometry that we can import. An incredibly powerful feature of the Sketcher workbench is that we can switch all the drawing tools to 'construction' mode. In a new project, again move to Part Design, create a new body, and create a sketch in the XY plane. Find the tool icon that looks like a red box over a blue dashed box, where the tooltip reads 'Toggles the toolbar or selected geometry

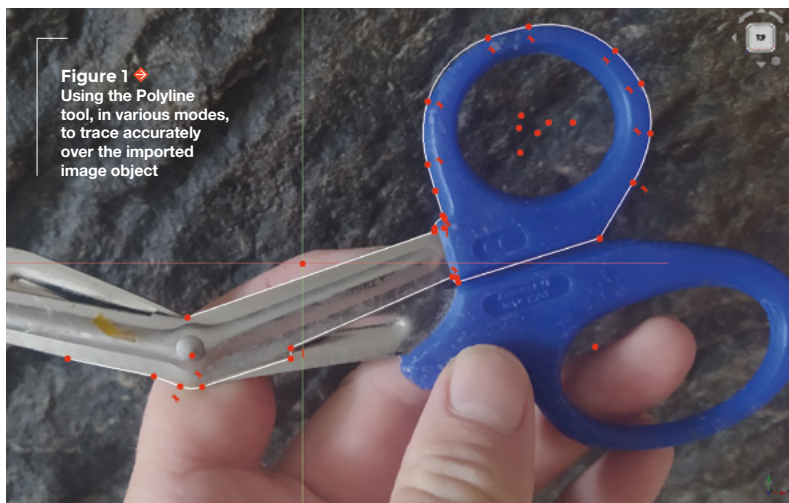

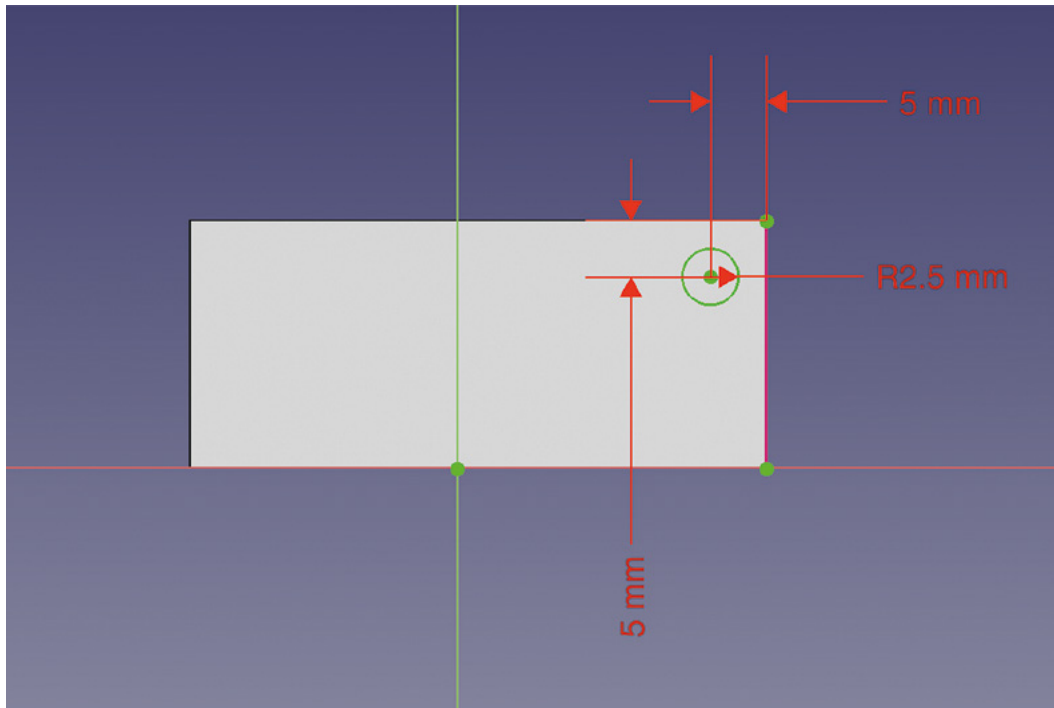
**YOU'LL NEED**

A computer with FreeCAD 0.19

QUICK TIP

We covered the basics of Part Design and the Sketcher workbench back in issues 37 and 38.

to/from constructions mode', and click it. You should see that all your drawing tools now turn from white lines in the icon to blue.

You should note, at this point, that drawing whilst in construction mode is exactly the same as standard mode. All the tools work in the same way; however, the geometries drawn will appear as blue lines and, when you move back to the Part Design workbench or other workbenches, you won't be able to see any construction geometry. The power of construction geometry is that, when you toggle back to normal geometry to draw visible parts of the sketch, you can, of course, attach points or constrain visible sketch edges and point to the construction geometry. Toggle back to normal drawing tools, and let's work through an example to show this in use.

In **Figure 3**, you can see the completed object we are aiming to make. We'll use some construction geometry to help, but along the way we will also explore the 'Create a slot' tool that we haven't used yet in this series. First, let's draw a standard circle in our sketch. Select the circle drawing tool and, starting from the origin point, draw a circle. Double-check your circle is centred to the origin, and then use the 'Constrain an arc or circle' tool to set the diameter of the circle to 30mm. Due to the nature of the plane origin point and axis lines, you might now appreciate that we have the Y axis line onto which we can attach one of our slots correctly but that, as there are three equally spaced slots, we don't have geometry onto which we can constrain the further two slots. We can solve this by drawing two construction mode lines.

Click the 'Toggles the toolbar or selected geometry to/from constructions mode' once more, and then select the 'Line' tool. Click and draw a line that starts at the origin point and moves out at an angle to meet the edge of the circle. Do this twice, with one construction line in the lower right-hand quadrant of the circle, and one in the lower left (**Figure 4**).

Often we may need a guide point in a position where there is no underlying geometry that we can import

Next, click the 'Fix the angle of a line or the angle between two lines' tool, and select the vertical Y axis line and then the lower right-hand construction line. As we want the three slots to be equally spaced, set this angle to 120 degrees. Repeat this, selecting the Y axis line and the lower left construction line so that →

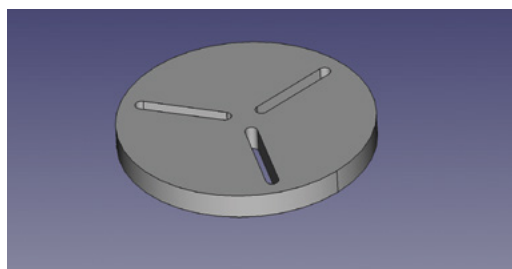

Figure 2 Using imported external geometry to create a guide point to constrain items to

Figure 3 This slotted plate uses construction mode geometry to aid the placement and constraining of the slots

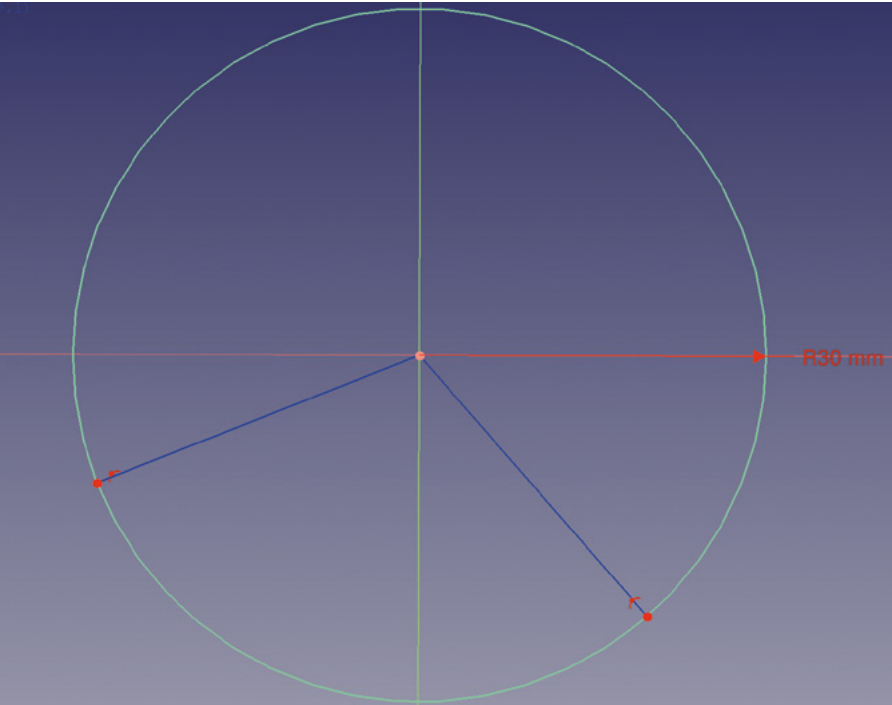
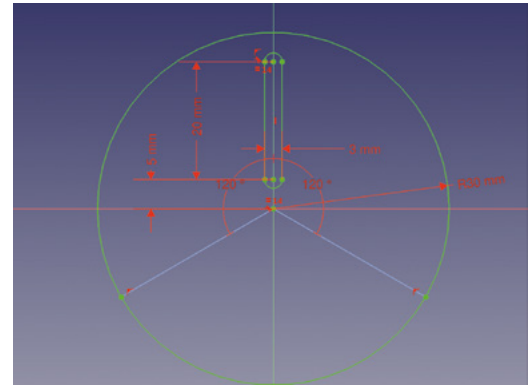

Figure 4 ◆

Setting up a pair of construction lines to be constrained to the correct angle to align our slots

Figure 5 □

Our construction lines created and the first slot added and constrained on the Y axis line



we have both our construction lines correctly positioned (**Figure 5**).

Select the 'Create a slot in the sketch' tool, and make sure you have toggled the drawing tools back to normal mode and you aren't still drawing in construction mode. Draw a slot by clicking somewhere on the vertical Y axis line and dragging down towards the centre of the circle, but don't connect the sketch to the centre origin point. Notice that when you draw with the slot tool, numerous constraints are automatically added, and this includes that the slot is either vertically or horizontally constrained. Let's fully constrain this slot. Begin by selecting the lower point on the Y axis line and set a vertical distance between it and the origin point of 5mm. Next, select the two points in the slot that are on the centreline, and create a vertical distance between them of 20mm. To set the width of the slot, select either set of two points that are at the end of the outer line, and mark the connecting point of the arc which forms the slot end. With two selected, set the distance between them as 3mm. This results in a fully constrained slot with a length of 23mm (slot length, plus the radius of the arc at each end) and a width of 3mm (**Figure 5**).

'M' HOT KEY

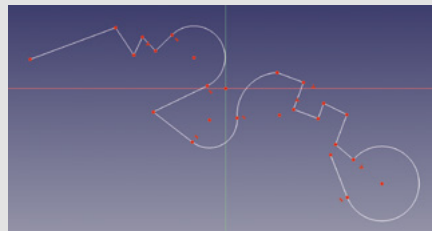

A very useful feature within the Sketcher workbench, when using the Polyline tool, is the **M** hot key. When the Polyline tool is in use, pressing the **M** key cycles the tool through various modes that are incredibly useful. To explore this in a new sketch, select the Polyline tool and draw a few random lines in the standard mode. Without right-clicking to complete a polyline, press the **M** key once. This first new mode enables you to automatically place a right angle line segment. Click the **M** key once more, and it will cycle the angle placement relative to the last polyline point. Click **M** again, and you can now draw an arc that is anchored tangentially on the last point of the line. Another **M** press changes the arc orientation, and a final **M** press allows you to draw an arc anchored to the last point, but not tangential. Whilst this sounds complex in description, it's simply a case of playing with the Polyline tool and it soon becomes instinctive.

QUICK TIP

The Image workbench works with lots of common file types, including SVG. However, you might be able to import an SVG as geometry, negating the need to sketch it!

SORTING YOUR SLOTS

To draw the other two slots is slightly more complex. Draw a slot of any size in the lower left-hand quadrant. Again, the drawn slot will be constrained to vertical or horizontal automatically, and so we need to delete those constraints to be able to position it on an angle. Find the small red horizontal or vertical dash that is the constraint. Highlight this with a left-click and delete it with the **DELETE** key. You should now be able to drag the slot into an angled position. To correctly place the slot following the construction line, we can use a single symmetry constraint. First, select two points that are at the end of the same arc forming the end of the slot, and then select the construction line. Next, click the 'Create a symmetry constraint between two points with respect to a line or third point' tool – this should now constrain the slot

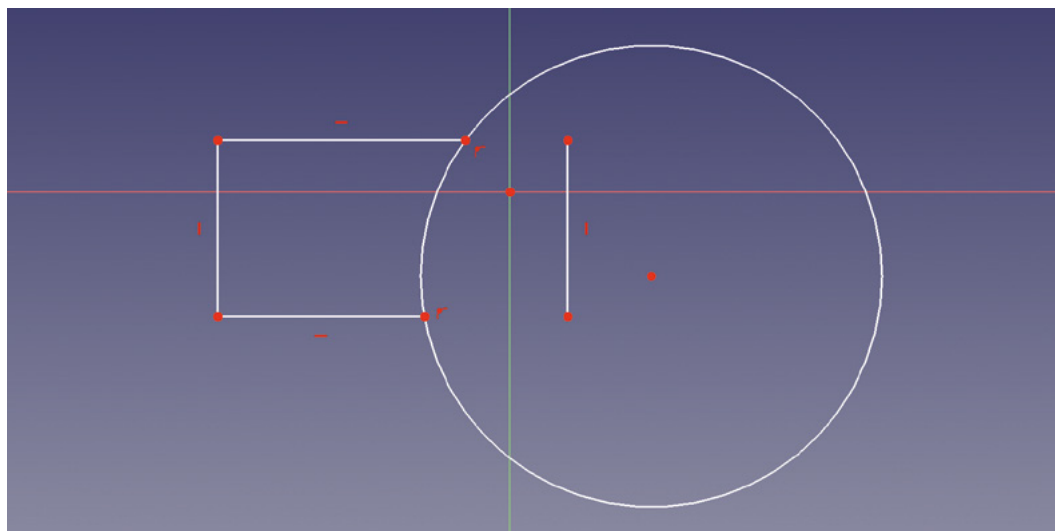

QUICK TIP

Most of the functions we have shown in this article work whether you are in construction or normal mode in Sketcher.

Figure 6 ♦ Using the 'Trim an edge' tool to remove intersecting lines

to be aligned with the construction line perfectly. We can now add distance constraints to bring the slot to the same relative position as our first slot. However, note that, due to the angle, we can't use vertical or horizontal distance constraints, so we need to use the 'Fix the length of a line or the distance between a line and a vertex' tool.

Repeat the above to get all three slots fully constrained, and then close and pad the sketch to get the final result. Whilst this is a relatively simple example, it does show how combining construction geometry alongside regular geometry is a powerful sketching approach. You can use all the drawing tools in construction mode and, as such, there is no end to the possibilities.

Moving away from construction mode, another really useful pair of tools are the 'Extend an edge with respect to the picked position' and the 'Trim an edge with respect to the picked position' tools, the latter of which is particularly powerful. If you have used Inkscape, the excellent open-source 2D vector graphics software, you probably have used the concept of Boolean operations, union, difference, intersection, and more, to combine different primitive shapes. This is similar to how, in the Part workbench, we use Boolean operations to combine primitive solids. It's a feature in Sketcher that I missed at first, until I discovered the 'Trim an edge with respect to the picked position' tool. As a simple example,

let's open a new project and again move to the Part Design workbench, create a new body, and then a sketch on the XY plane.

In this sketch, first let's select the 'Create a circle in the sketcher' drawing tool, and draw a circle anywhere on the plane. Next, select the 'Create a rectangle in the sketcher' tool, and draw a rectangle that overlaps the circle. If we now select the 'Trim an edge with respect to the picked position' tool, we can use this to get rid of parts of lines we don't require.

If you click a line that intersects another line, that line section will be deleted, even if they are from separate objects like our circle and our rectangle.

In **Figure 6**, you can see that we have deleted two line segments inside the circle that belonged to the rectangle circle.

We can of course also remove the line that belongs to the circle that is in between the lines of the rectangle in exactly the same manner. That just leaves the now disconnected line left over from the rectangle that is free-floating inside the circle (**Figure 7**). If we now try and use the 'Trim and edge with respect to the picked position' tool, we will get an error message. The Trim tool is only of use when a line intersects or is connected to another line. If we had deleted this line first using this tool, it would have worked as it was still connected to the rectangle, but now this tool will fail. For non-connected lines such as this one, you can simply left-click on it to select it as an item and press the **DELETE** key. →



The Trim tool is only of use when a line intersects or is connected to another line



QUICK TIP

When you import an image, it tends to import in an angled view. The view buttons and cube work exactly the same with the image plane, and pressing 'top' will give you a top-down view.

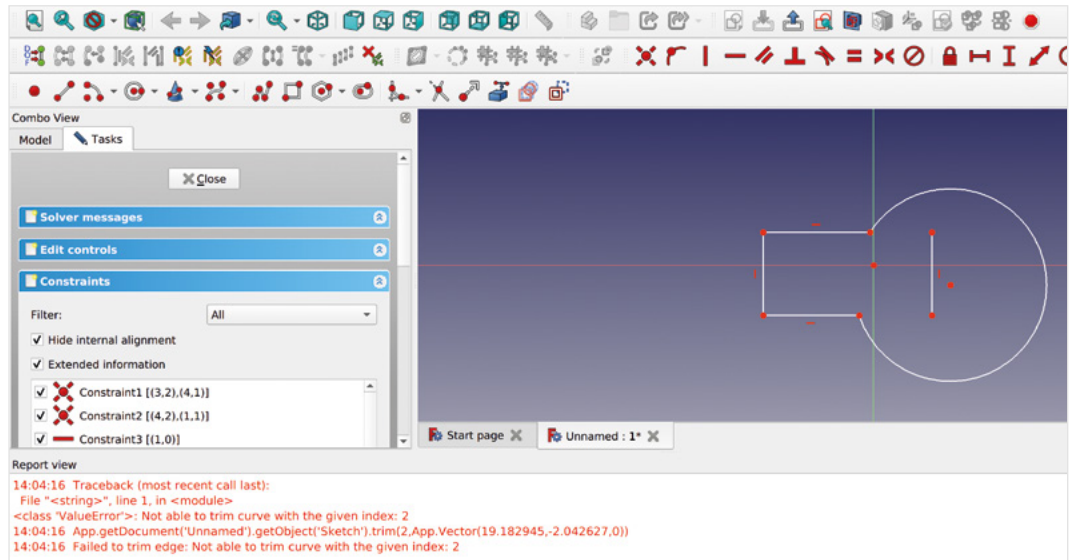

A similar useful tool is the 'Extend an edge with respect to the picked position' tool. In a new project and a new sketch, draw a rectangle and then draw some polylines near the rectangle that don't quite meet the rectangle lines, similar to **Figure 8**. Next, select the 'Extend an edge with respect to the picked position' tool and left-click on one of the lines that doesn't meet the rectangle. If you move the cursor, you can now extend this line to any position you like or, as it crosses the line forming part of the rectangle, that line will become highlighted meaning that you can attach the line to the rectangle at that point (**Figure 9**). This tool works not just on straight line geometry, but will also work to extend arcs and more.

Another slightly advanced sketching approach is the concept of sketching over an imported image, or images, to create some geometry that matches a real-world object. To do this we can use a separate

workbench, 'Image', to import picture files to particular planes. We also can then scale the images correctly and more. Let's create a new project and move to the Image workbench. On the Image workbench, you will see that there are three main tool icons. Find the tool icon that reads 'Create a planar image in the 3D space' and click it. Next, navigate to a picture file you want to import (**Figure 10**).

FINAL STEPS

Once you select an image, you will get a dialog box asking which plane you would like to attach the image to. We opted for XY in the first instance. The dialog box also has an 'Offset' input box – this is the distance from the selected plane where the image is placed. It's useful, when intending to trace parts of the image in Sketcher, to have the image placed slightly under the plane, so we added a -0.1 mm offset before clicking OK. You should now see your image loaded onto the selected plane and you can see an 'imageplane' object appear in the file tree view. Of course, like most items in the file tree, you can toggle the visibility of the imageplane item on and off using the **SPACE** bar.

Having imported our image successfully, we can switch to the Part Design workbench. Create a new body and then create a new sketch in the XY plane. If you imported the image with the correct negative offset, you should now see the image in the Sketcher workbench but with the datum lines above the image. To double-check, draw a shape in the sketch and make sure it appears over the image. You can now begin to draw and trace parts of your image using the Polyline tool. Using the **M** key to cycle through the different polyline modes, as described earlier in this article, can allow you to quite quickly create outline-traced sketches of quite complex items (**Figure 1**).

Figure 7 Trying to use the Trim tool to delete the final unconnected edge will result in an error. However, we can simply select the line and delete it

Figure 8 Setting up some lines that don't meet, for our example of using the 'Extend an edge' tool

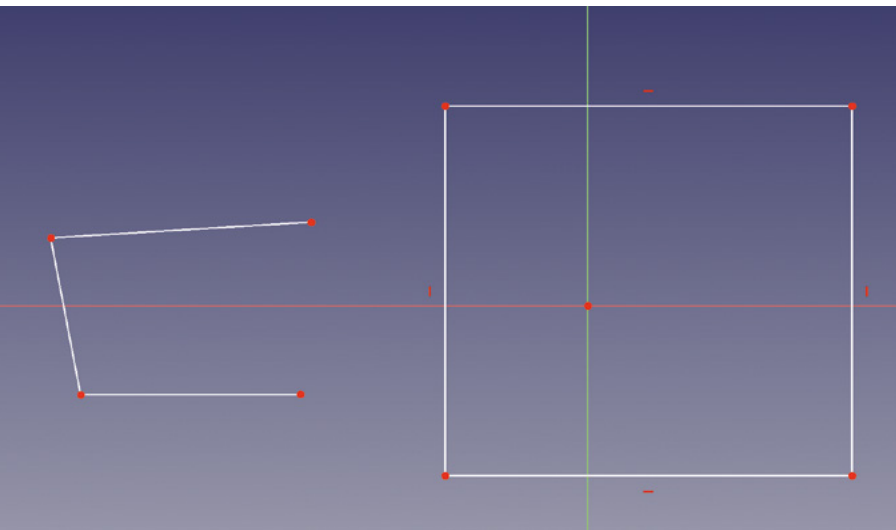

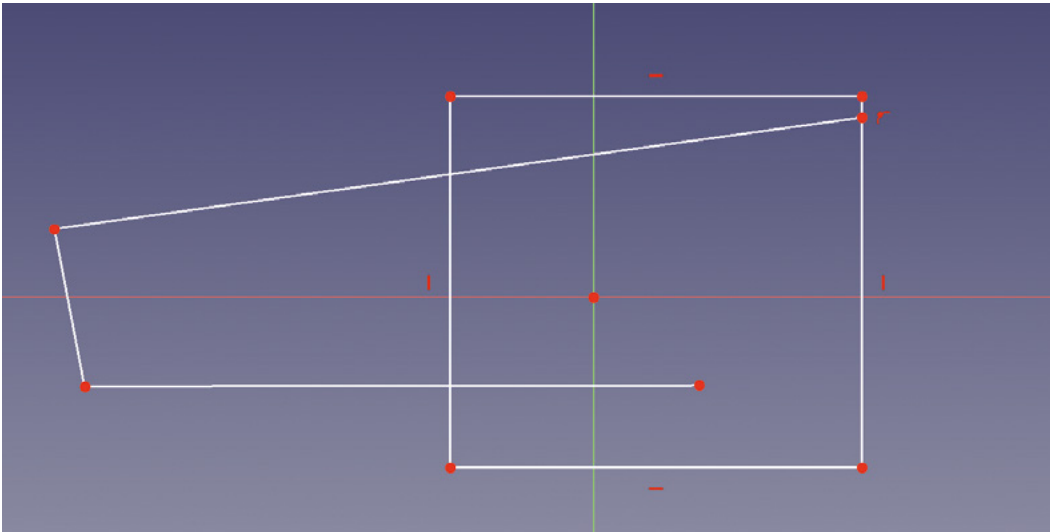

Figure 9 ♦
The lines are now extended into the rectangle – the upper line has been constrained onto the upright line of the rectangle

Figure 10 ♦
A photograph imported to the XY plane, and appearing in the preview window and in the file tree view

Tracing imageplane objects is an excellent approach, but one problem is that images, especially photographs, rarely scale correctly when imported. If you have followed along and imported an image and traced (or partially traced) parts of it, as a test, select a line and click the 'Fix a length of a line or the distance between a line and a vertex' constraint tool. You'll probably see that the length of the line doesn't match the reality of the object. In our case, if we click the first line on the upper part of the metal blade of our shear in **Figure 1**, we get a length of 105mm, which is way too big. Whilst there are ways to scale a complete sketch using the Draft workbench, a better approach in this instance is to scale the imageplane object before we do too much work with it. If we have access to the object in the image, we can simply measure a part of the object.

To scale our image plane object correctly, let's hide the sketch by toggling its visibility in the file tree using the **SPACE** bar. Then, return to the Image workbench. Click the 'Scales an image plane by defining a distance between two points' tool icon and a 'Scale image plane' dialog box will appear. First, input a known distance that applies to two points on the object. So we input 46mm. You then click on the first point on the imageplane object, so we clicked on the point on the top of the blade at the fulcrum point on the shears. Next, you click the second point representing the other end of the distance you input. In our case, this is the point at which the upper blade joins the handle. Finally, the dialog asks you to click the imageplane object you want to scale. Then you click OK, and the imageplane object is now scaled correctly to the object (**Figure 11**).

With a little forethought, we can make our image scaling process a little easier and more accurate. If we are creating the image ourselves, there are a couple of things we can do. Firstly, ensuring that our image

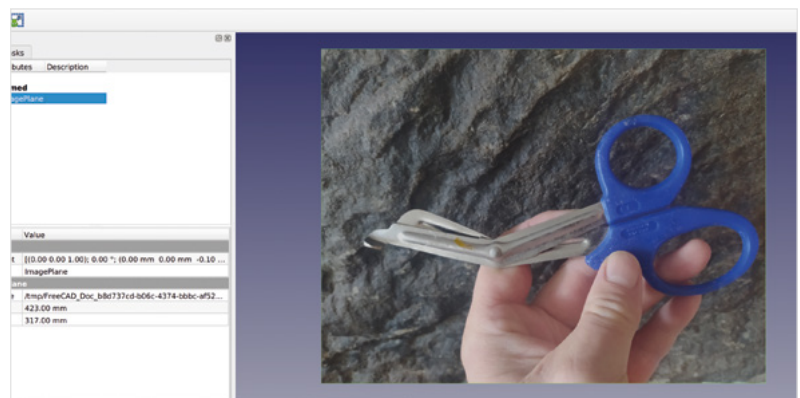

is parallel to the object means that when we trace the item, we aren't tracing a skewed version of it. Making sure a photograph is taken directly from above can help; or, if sizes allow, even better is to create a scan image of the object on a flatbed scanner. Finally, if you add a ruler or a cutting mat with a grid to the background of your image, you can use this as the reference points for the 'Scale image plane' tool for really accurate results. □

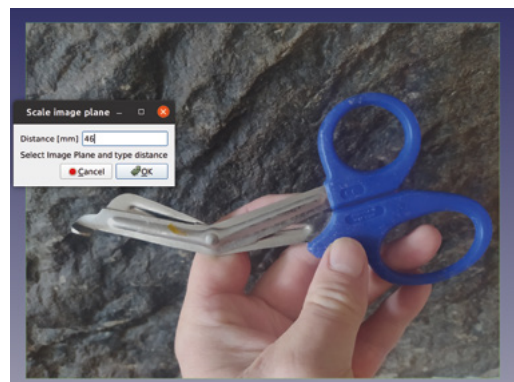

Figure 11 ♦
Using the 'Scale image plane' tool to make our reference image the correct size



3D photography – a practical guide

Ever thought your photographs lacked reality? Mike Bedford shows you how to give them real depth by delving into stereo photography



Mike Bedford

Despite loving all things digital, Mike admits to being a bit of a luddite, vinyl records and all.

Above

If you pick up second-hand compact cameras and fix them next to each other on a flash bracket, you've got a low-cost stereo camera

To a photographer, 3D can mean so many different things, which isn't too surprising because our eyes and brains use so many different ways to perceive depth. Much of the information we use – like perspective – is present in ordinary photos, but one important element is missing. That's something called binocular disparity, and it means that our two eyes see a scene from two slightly different viewpoints. The additional information this provides is processed subconsciously by our brains to enhance the feeling of depth and usually, when TVs, movies, or cameras are described as 3D, it means they provide binocular disparity. However, you don't have to buy a special camera to take three-dimensional photos. Here, we'll show you three different ways of taking 3D photos, and follow this up by looking at how to process them

so you'll be able to view them and experience that 'wow' feeling.

INTRODUCING STEREO PAIRS

Just as having two eyes is a key element of 3D vision, capturing a scene from two different viewpoints is essential for 3D photography. The result is a pair of photos – the left and right eye views – called a stereo pair. But this is just the start. To see depth, you have to view the pair so that your left eye sees only the left-eye image, and your right eye sees only the right-eye image. We'll look at two ways of doing that later but, to start, let's see how to capture the images.

The easiest way is to use just an ordinary camera, taking two shots but moving the camera horizontally by about 70 mm – the distance between your eyes – between the shots. It might not give the best results, but do try this out before moving on to more advanced



methods. For a camera with an optical viewfinder, like an SLR, hold the camera to your left eye and take a photo, then move it to your right eye and take another. If your camera has an LCD viewfinder, hold the camera securely while looking at the viewfinder, take a shot with your weight on your left foot, then transfer your weight onto your right foot and take another. Whichever method you use, try to keep the camera at the same height and facing in the same direction for the two shots. When you've taken a few stereo pairs, you'll probably want to jump forward to our description of how to process the images, so you can admire your handiwork before backtracking to discover some better ways of capturing stereo pairs.

USING TWO CAMERAS

3D cameras with two lenses are occasionally manufactured, but they're expensive. However, you can come close by using two cameras side by side. If you buy new cameras, that'll be expensive, but shopping around for two identical second-hand cameras offers an affordable option. The two cameras need to be mounted next to each other on a rigid support. We suggest using a flash bracket, the type that has two tripod screws, one for the camera and one for an off-camera flash, but use both for your two cameras. So both cameras capture the scene

at exactly the same time – important if anything is moving – ideally, you should trigger them both with a remote control. Also, both cameras must be at the same zoom level. So, unless the camera menus allow you to select a zoom level, the only option is to use both cameras at either their minimum or maximum zoom setting.

Another option that gets even closer to a dedicated 3D camera is to build your own. At one time this would have been unthinkable, but with a Raspberry Pi and a couple of Camera Modules, this becomes a possible if slightly ambitious project. You'd probably base it on an ordinary 2D Raspberry Pi camera →

Above ♦ Anaglyphs don't look too promising at first sight, but with a pair of red-cyan glasses – reminiscent of horror movies in the 1950s – all that changes

POLARISING

If you bought a TV during the most recent 3D craze a few years ago, it might allow you to view your stereo pairs in 3D. But have you ever wondered how a 3D TV works? The bottom line is that it displays the left and right images alternately at high speed. Each time it flips between photos, it polarises the light oppositely. The glasses that you wear have differently polarised filters for the two eyes. Because light will pass through a filter with the same polarisation, but will be blocked by a filter with the opposite polarisation, each eye ends up seeing only the image that's intended for it.



Above ♦
In this front view of our mirror rig, you can see two lenses: the actual camera lens and a virtual reflected lens. Each takes one image of the stereo pair

Below ♦
Here we see the mirror rig from the top, to give you a better idea of how it was constructed

project, but modifying it by addressing the issue of attaching two cameras to the Raspberry Pi.

SLIDE BRACKET

Next is a solution that requires just a single camera, so it's going to be cheaper – in fact, you'll probably use a camera you already own. Really it's just a more sophisticated version of the simple approach of moving the camera between your two eyes. It's not going to work if the scene contains moving objects, but it's a really simple method. Without some additional hardware, taking two photos with the same camera risks the framing of the scene changing between shots. The software we're using can correct

HOLOGRAMS

Seeing a photo with binocular disparity for the first time is quite an eye-opener, but stereo photography isn't the ultimate 3D experience – enter the hologram, a proper hologram, not a mobile phone gimmick. As well as providing binocular disparity, a hologram lets you choose whether to focus your eye on near or far objects, and if you move your head left and right, objects that were previously hidden by closer objects come into view. The snag is that a hologram has to record features as small as the wavelength of light, and digital image sensors don't come close, so you have to use ultra-high resolution photographic film. Oh, and while you're taking a shot, vibrations or air currents mustn't cause your rig to move even by the tiniest part of a millimetre. Let's just say it's challenging.

this sort of error, but for best results, it's good to get them as close as possible when you take the photos. You can buy slide rails that you attach to a tripod before attaching the camera to the rail, so you can slide the camera horizontally, remaining at the same height and pointing in the same direction.

Our solution is similar, although it's much easier to make. We call it a slide bracket, and looking at the photo (**Figure 1**, overleaf) will be enough for you to figure out how to build and use one. We made ours from chipboard, gluing and screwing the joints, and embedding a tripod socket in the base. Ideally, to eliminate any possibility of scratching your camera when you slide it, we recommend gluing some fabric





such as velvet to the inside surfaces of the base and the back of the bracket.

MIRROR RIG

Our next method uses only one camera, and the two shots are captured at exactly the same time, so it'll work with moving objects. It might seem to offer the best of both worlds, although there are drawbacks. Even so, if you get bitten by the 3D bug, this is surely something you'll want to try, but we'd have to call it experimental.

The method involves taking a single photo while holding a mirror to the side of the lens and almost perpendicular to the camera. Assuming the mirror is to the left of the lens, the resulting photo has a horizontally mirrored version of the left-eye image on the left, and the right-eye image on the right. The drawback is that each image appears in only half of the full frame. Also, it captures part of the scene that doesn't appear in both images, so the useful area of each is a square or tall thin rectangle. For some subjects this is fine – but not, for example, with most landscapes.

Rather than holding the mirror by hand, you'll need to fix it in place. The exact arrangement of the rig will depend on your camera, and you'll have to fine-tune the size of the mirror, the horizontal separation between the mirror and the camera, and how much the mirror's far end is angled inwards. However, our photos should provide a good starting point. For your initial tests, use acrylic (Perspex) mirror material

because it's easy to cut. You'll notice, though, that you'll get quite bad ghosting in the reflected image which, at best, causes a lack of sharpness. So, having determined the size that you'll need using

ordinary acrylic mirror material, if you want to go further, you should buy something called first surface mirror (or front surface mirror), which has the reflective coating on the surface, not behind the glass or acrylic, thereby

preventing ghosting. Acrylic first surface mirrors are available, but they cost more than ordinary mirrors, and it's easy to damage the reflective layer. To keep the mirror rigid, and for ease of fixing, we attached it to plywood, with a non-solvent adhesive. Keep the weight of the backing material to a minimum to →

“

If you want to go further, you should buy something called first surface mirror (or front surface mirror)

”

Above ♦

A side-by-side view is the easiest way to present a stereo pair, but unless you invest in a stereoscope, it takes some practice to view it in 3D

Below ♦

Viewing an anaglyph with red-cyan glasses means that the left eye sees only the left-eye image, and the right eye sees only the right-eye image

(Public domain, from commons. [wikimedia.org/wiki/File:Plastic_3d_glasses.jpg](https://commons.wikimedia.org/wiki/File:Plastic_3d_glasses.jpg).)



TUTORIAL

prevent the mirror sagging at the far end, especially if you're using a large mirror or a long arm, as we did. We built the supporting structure from angled, perforated aluminium strip, using machine screws and nuts to fix it all together, and short wood-screws to attach the plywood to the framework. The mirror rig and camera are connected together using a flash bracket. We found, when using an SLR, that the rig is best for reasonably close-up subjects, but at longer range, it doesn't make especially good use of the sensor area. Our tentative tests with a compact camera suggested that it's better than an SLR with longer-range subjects.

PROCESSING STEREO PAIRS

All the processing can be done using the free StereoPhoto Maker (hsmag.cc/StereoPhotoMaker). It can even flip the reflected image taken with the

mirror rig at Edit > Rotate/Flip Image > Horizontal flip (left). Also, although it's better to get as much right as you can when you take the stereo pair, it will also correct any discrepancies between the two shots (Adjust > Auto Alignment), including the distortion in the reflected image caused by a mirror rig, and it prepares the stereo pair for 3D viewing. There's plenty of good documentation, so you'll easily learn how to use it, but we'll introduce you to a couple of the display options that StereoPhoto Maker supports.

First up is 'Side-by-side' images, which is exactly what it sounds like: the left and right images displayed side by side for printing or on-screen display. Surprisingly, this allows you to view the scene in three dimensions, and it's easiest if they're the correct size. It requires some practice, but if you

Below

This is an image taken on a compact camera using the mirror rig, straight out of the camera. The reflected left-eye image has ghosting because we didn't use a first surface mirror, and you'll see that the usable area, which is common to both views, is a fairly narrow vertical strip



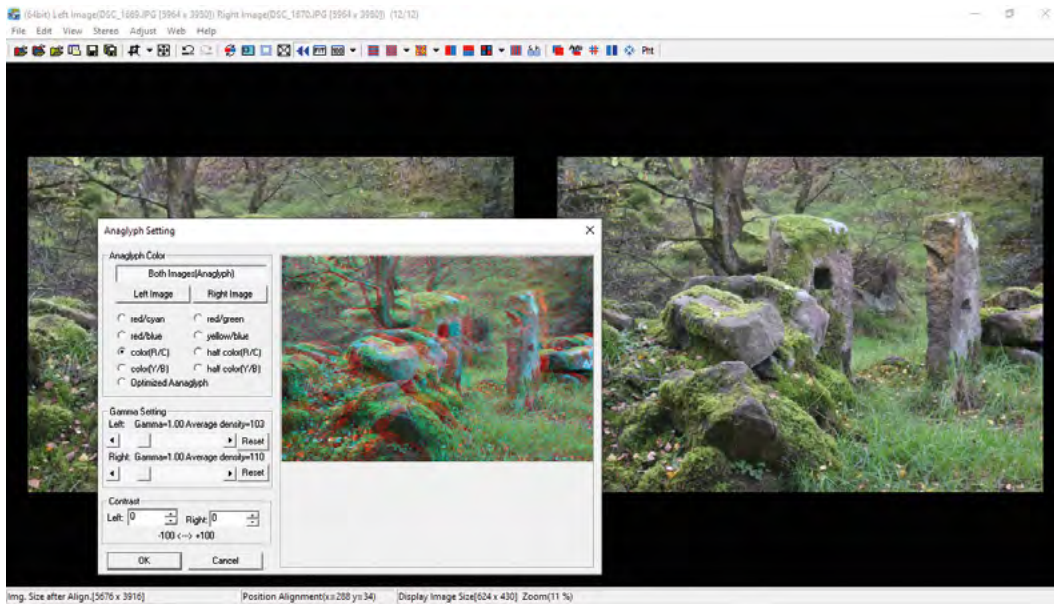

Left ◆ StereoPhoto Maker is a one-stop shop for all your stereo photo processing needs. Here we're processing a stereo pair taken with the slide bracket

Below Left □ Using a stereoscope – like this cheap one or more expensive ones that allow you to view larger images – lets you view a stereo pair without mastering visual tricks

Figure 1 ◆ A slide bracket couldn't be much easier to construct, and so long as your scene doesn't contain moving objects, it provides an ideal route into 3D photography

can view Magic Eye images, then you'll be able to view a Side-by-side stereo pair. And if you haven't acquired the knack, there's no shortage of tutorials online. Actually, there are two forms of side-by-side viewing, and they require different preparation and viewing techniques, so read up on both parallel and cross-eyed viewing. As an alternative to free-viewing, you can buy stereoscopes – simple optical devices that let you view a stereo pair if you don't have the knack to do so without – and some will work with larger images.

There's an alternative way of processing and viewing a stereo pair that doesn't need visual gymnastics or buying viewing equipment. It's called an anaglyph, and it comprises the red component of the left-eye image superimposed on the cyan



// This allows you to view the scene in three dimensions, and it's easiest if they're the correct size //

component of the right-eye image. Because red and cyan, between them, allow all colours to be displayed, the result has approximately the correct colours, although some objects will have red and cyan fringes. Not very promising, you might think, but don a pair of red/cyan glasses and all this changes. Because the red lens allows red light to pass but blocks cyan light and vice versa, each eye sees only the image intended for it and, hey presto, you've got a 3D image. □

CODE
THE
CLASSICS
VOLUME 1

CODE THE CLASSICS VOLUME 1



Brimble
Crookes
Gillett
Malone
Tracey
Upton





CODE THE CLASSICS VOLUME 1

This stunning 224-page hardback book not only tells the stories of some of the seminal video games of the 1970s and 1980s, but shows you how to create your own games inspired by them using Python and Pygame Zero, following examples programmed by Raspberry Pi founder Eben Upton.



- *Get game design tips and tricks from the masters*
- *Explore the code listing and find out how they work*
- *Download and play game examples by Eben Upton*
- *Learn how to code your own games with Pygame Zero*

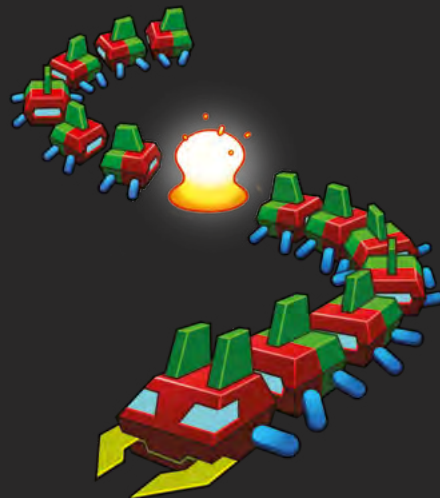

Available now hsmag.cc/store

Make a Pico MIDI 'crackers' controller and a Pure Data sound synthesizer

Create synth sounds and hardware to control them



Rob Miles

@robmiles

Rob Miles has been playing with hardware and software since almost before there was hardware and software. You can find out more about his so-called life at robmiles.com.



Create a Pico-powered MIDI controller and connect it to a Pure Data digital synthesizer. This works well with the Pico musical cheese box described in issue 48 of HackSpace (Figure 1).

THE PICO MIDI CONTROLLER

The article 'Make a Pico musical cheese box', in HackSpace issue 48, described how to use a Raspberry Pi Pico to make a device that transmits MIDI notes and drum patterns. We used it to control a Pure Data music patch running on a Raspberry Pi, which made sounds from audio samples and sine waves. In this article, we are going to create a 'crackers' controller to go with the cheese box. Then,

we'll make a Pure Data digital synthesizer to run on the Raspberry Pi to create interesting sounds, and use the crackers controller with it.

INSIDE THE BOX

Figure 2 shows the contents of the box. The wiring looks a bit crackers (hence the name), but it worked first time. The trick was to have a full circuit diagram before starting construction, and then connecting each cable in turn.

Figure 3 shows the circuit for the box. Two ground connections are used: one for the pixel rings, and another for the buttons and rotary encoders. You could control more values by adding more buttons and pixel rings.

Figure 1 The 'crackers' MIDI controller is on the left. The red parts of the rings around each of the four knobs indicate the level of that setting. The other colours (blue, green, yellow, and magenta) indicate which setting is being controlled by that encoder. The musical cheese box is on the right

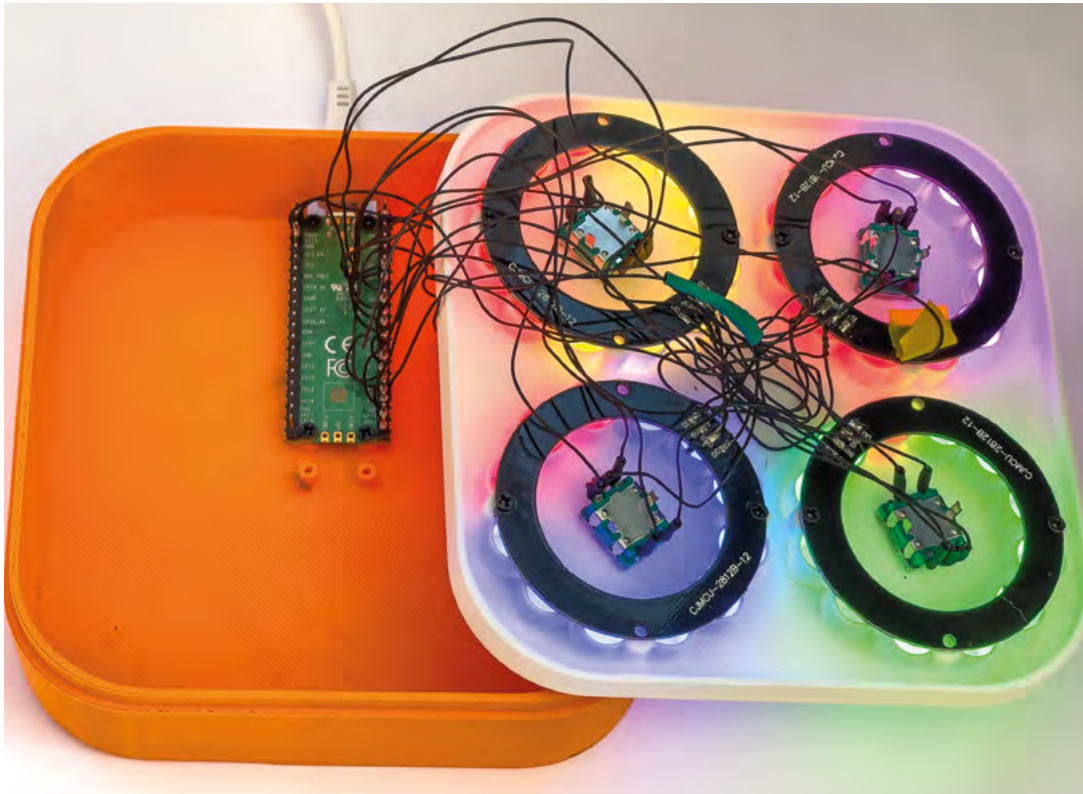

Figure 2 ♦ The box contains mounting pillars for a second Pico in case two devices were required: one to scan the encoders and another to send the MIDI messages. Fortunately, it turns out that a single Pico can handle both tasks quite happily

Figure 3 ▣ Each encoder uses three data lines: two for the rotary encoder and a third for the button you can trigger by pressing the controller knob down

DIGITAL ROTARY ENCODERS

The user of the controller will adjust the synthesizer settings by turning knobs connected to rotary encoders. The encoders generate two streams of ‘on-off’ pulses as the knob is rotated. The Pico microcontroller reads these streams and calculates the distance and direction of the rotation.

Figure 4 shows the signals produced by a rotary encoder. The encoder was turned two ‘clicks’ forward and then two clicks back. For the first two clicks, the upper signal goes high first, but for the second two clicks, the lower signal changes first. This is how the

software can determine the direction and movement of the encoder. CircuitPython provides a **rotaryio** library that does all the hard work of reading these signals. The library contains an **IncrementalEncoder** class that reads encoder movement.

```
import board
import rotaryio
import time

# create the encoder
encoder= rotaryio.IncrementalEncoder(board.GP8, →
```

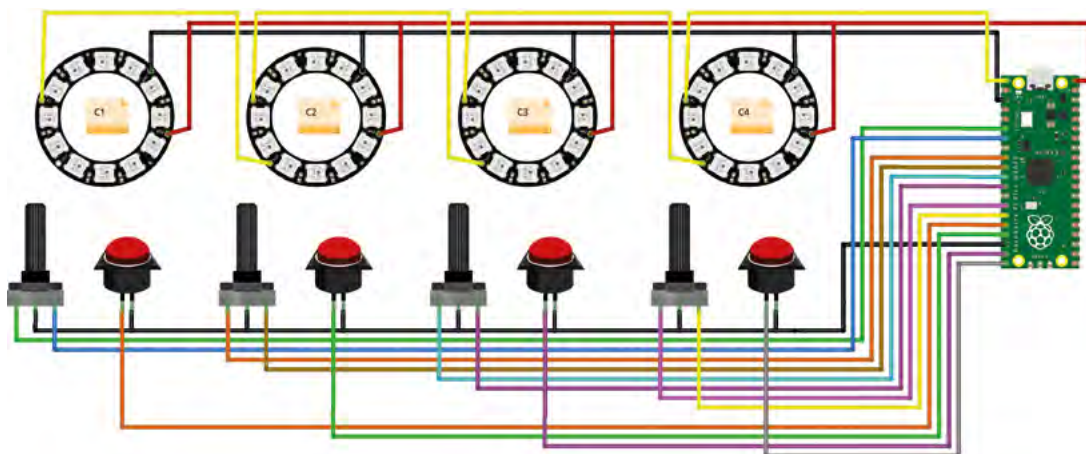

YOU'LL NEED

- ♦ A Raspberry Pi Pico
- ♦ A micro USB cable to link the Pico to the host
- ♦ 4 × 12-pixel WS2812 pixel rings (search for ‘WS2812 ring 12’)
- ♦ 4 × rotary encoders with push-buttons (search for ‘Arduino rotary encoder’)

TUTORIAL

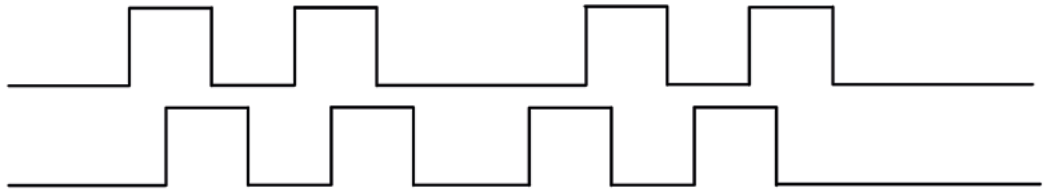

Figure 4

The switches in the encoder generate the 'low' part of their output by connecting the input to ground

Figure 5

This dialog is opened by the selection File > Preferences > MIDI, and then clicking the button 'Use Multiple Devices'

```
board.GP9)

# repeatedly print the encoder position
while True:
    print(encoder.position)
    time.sleep(0.5)
```

The code above shows how to read position values from an encoder. It creates an 'IncrementalEncoder' object called `encoder` which is connected to pins 8 and 9 on the Pico. The code reads and prints the encoder position every half second. An IncrementalEncoder object provides a position

property that gives the number of clicks that encoder has moved since it was last checked. The controller uses the position to update the value of the setting being controlled.

TAKING CONTROL

Now that we know how we are going to read the inputs from the user, we need to consider how to send this data into our synthesizer. We are going to use the MIDI (Musical Instrument Digital Interface) standard to connect our controller to a sound output device (in our case, a Pure Data program running on a computer). The MIDI standard allows different types of messages to be sent between devices. The crackers controller sends MIDI 'control' messages when the position of a knob changes. The messages will control the settings inside the Pure Data synthesizer. CircuitPython provides libraries that can be used to send MIDI control messages from a Python program:

```
import usb_midi
import adafruit_midi
from adafruit_midi.control_change import ControlChange
import time

midi = adafruit_midi.MIDI(midi_out=usb_midi.ports[1], out_channel=0)

count = 0
while True:
    print(count)
    midi.send(ControlChange(21, count), channel=0)
    count = (count + 1) % 128
    time.sleep(0.5)
```

The CircuitPython code above runs on a Pico device and shows how the MIDI control output works. It creates a MIDI port on the Pico, and then sends a sequence of control changes to controller number 21.

The range of control values that is sent is from 0 to 127 – which is the range of MIDI control values.

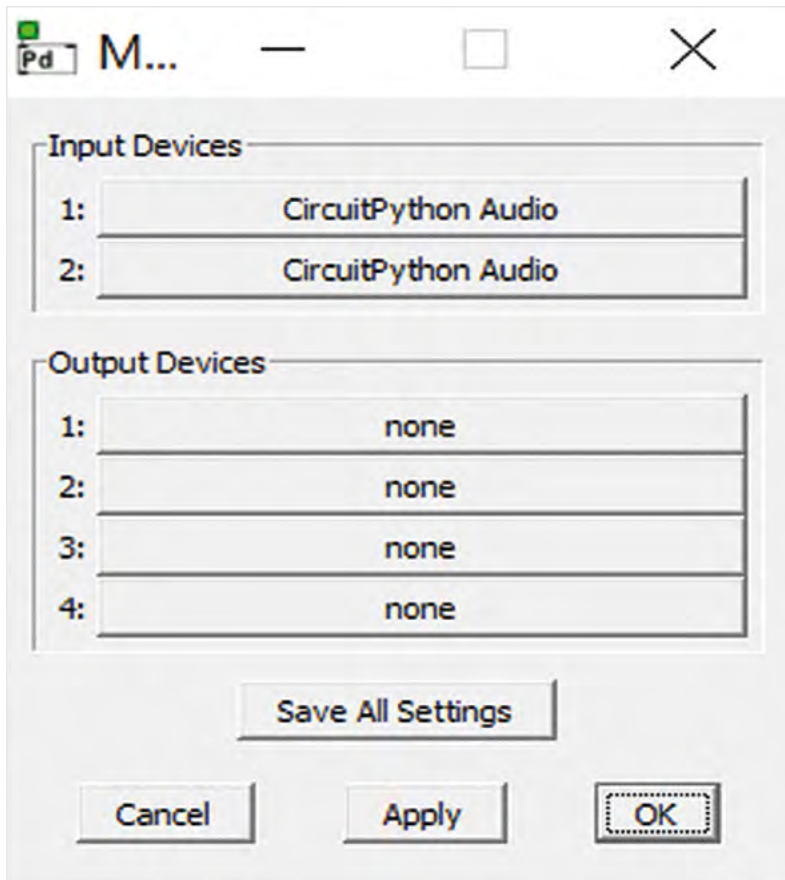

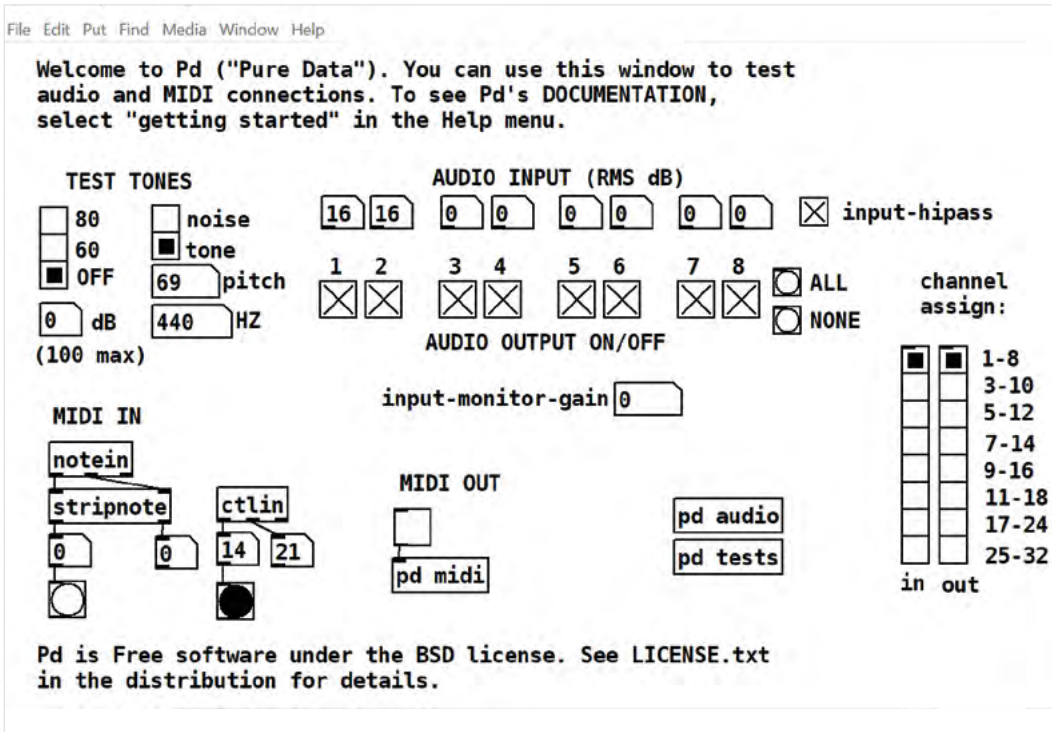

MIDI OF THE ROAD

A crackers controller running the above program is plugged into a USB port on a PC, or a Raspberry Pi, and recognised as a MIDI device by the operating system. A Pure Data application connects to the device and receives the messages. We have to configure Pure Data and tell it which MIDI devices to use.

Figure 5 shows the MIDI device selection dialog in Pure Data.

There are two input devices connected to the application. They are Pico MIDI devices that both have the name 'CircuitPython Audio'. One device is a

Pico MIDI cheese box keyboard, and the other is the Pico crackers controller. Once you have connected your devices, we can use the Media > Test Audio and MIDI selection to open a test patch and view MIDI

messages coming from connected devices.

Figure 6 shows the test patch running. In the bottom left we can see the ctlin object, which has just received the value 14 from controller number 21.

The MIDI standard allows different types of messages to be sent between devices

CONTROLLER DESPATCH

Pure Data programs are called patches, and are comprised of objects which are connected using →

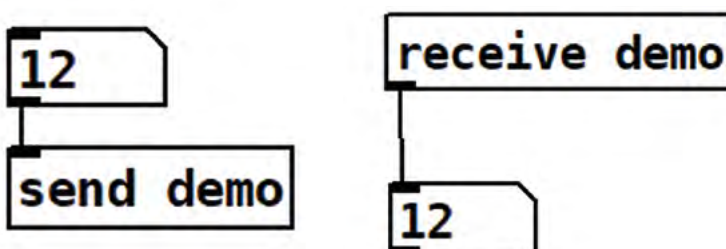

Figure 6 ♦ If you can't make your MIDI work, you might find that opening this test patch will cause everything to start working

Figure 7 ♦ Send can be abbreviated to s, and receive can be abbreviated to r

TUTORIAL

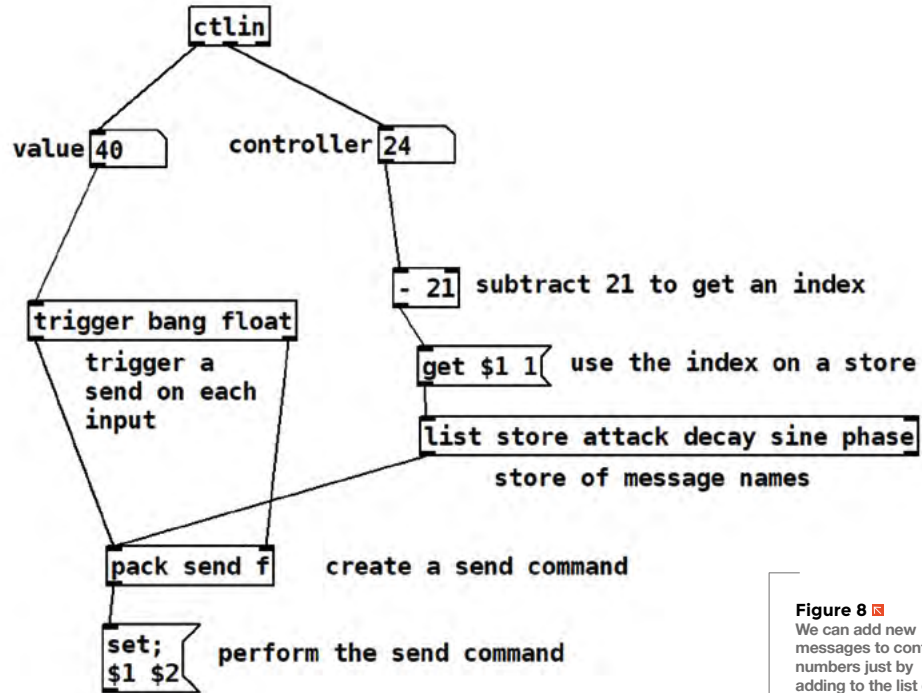

Figure 8 We can add new messages to controller numbers just by adding to the list of message names

'patch cords' which send values and audio signals. These are drawn in a patch as lines connecting the objects together. Patch cords are great for connecting objects in the same patch, but we would like to send the controller values into lots of different patches. We can use 'send' and 'receive' objects to do this. A send object takes an input and sends it to a named destination. A receive object picks up inputs from this destination.

Figure 7 shows how send and receive work. A number box (containing 12) is connected to the input of a send object that sends to the destination demo. If the value in the number box connected to the send box changes, the updated value will be sent to any receive objects listening to demo. This works across the entire application.

We can use a single send object and multiple receivers to 'broadcast' a message to lots of receivers, or a single receive object and multiple senders to 'collect' messages. The send and receive objects can be in different patches or in lots of places in the same patch. We need to be a bit careful, in that destination names are a bit like 'global' variables in procedural programs. If we start using the same name for different purposes, our patches will go wrong. We are going to use messages called 'attack',

We can use a single send object and multiple receivers to 'broadcast' a message to lots of receivers

'decay', 'sine', and 'phasor' to set control values in the sound generator patch.

Figure 8 shows how the messages are received from the MIDI controller and then routed to an appropriate send destination. The ctlin object at the top of the patch receives the value and the controller number. In Figure 8, the program has just received the value 40 from controller 24. Messages to

controller 21 are sent to the attack destination; messages to controller 22 are sent to the decay destination, and so on. You don't need to know how it works (although it might be fun to try and work it out). It uses some neat features

of Pure Data, including lists and the ability of the language to create and perform behaviours as it runs.

SOUND POLICY

The control messages are used to configure the voice patch that makes the sound. The voice patch we are using contains two oscillators; one makes a sine wave, and the other makes a 'triangle' wave. In a triangle wave, the amplitude of the signal goes up and down in a straight line. This leads to a 'harsher' sound, with more harmonics than a smoother sine wave.

Figure 9 shows the patch that generates the output. This patch has an inlet at the top which

receives messages containing the MIDI note number and velocity values of the note to be played. Each MIDI note number represents a particular note frequency. The velocity value gives the loudness of the note; the higher the velocity, the louder it should be.

The note number is converted into a frequency value which is used to control two oscillators, an osc~ (sine wave) and a phasor~ (triangle wave). The volume of the output from these oscillators is controlled by sine and phase values which are received from the controller. The controller value is divided by 127 to produce a value between 0 and 1, which is then used to control the volume of that signal. You can see these flows on the left-hand side of the patch.

The right-hand side of the patch acts on the velocity value received from the keyboard. It controls the envelope of the sound. This is how quickly the sound rises when it starts and falls when it ends. The select object selects the 'falling' behaviour when a note has a velocity of 0 and the 'rising' behaviour for any other velocity. The volume envelope is produced by a line object which is given two different sets of control values. The 'decay' line has an endpoint of zero and

a duration which is set according to the delay for the note. The 'rising' line has an endpoint of the note velocity, and a duration which is set according to the attack value.

MAKING SOUNDS

The top two knobs on the controller set the 'attack' and 'decay' values. A short attack value gives a very 'sharp' sound. A long decay value means that the note takes a while to die down. You can select whether you want a harsh-sounding triangle wave or a smooth sine wave by using the two lower knobs. You can use the crackers controller with any other program or MIDI device.

BOX SOFTWARE

You can download the software for the controller from the GitHub site for this project here:

hsmag.cc/CrackersController. The software is written in CircuitPython, which can be installed on your Raspberry Pi Pico using the image from here: circuitpython.org/downloads.

The software uses the Adafruit `adafruit_bus_device` and `adafruit_midi` libraries, which need to be copied into the `lib` folder on the CircuitPython drive of your Pico. You can find these using this link: circuitpython.org/libraries.

You can use Thonny (thonny.org), or Mu (hsmag.cc/InstallingMuEditor), on your computer to open the program and download it to your Pico. □

QUICK TIP

There is another type of rotary encoder called a 'potentiometer' or 'pot'. A pot can be connected so that a voltage is produced that reflects the current physical position of the shaft. This voltage can be read by an analogue to digital converter (ADC) to get a value that reflects the controller value. The Pico has three ADC inputs, so it could read three pot readings.

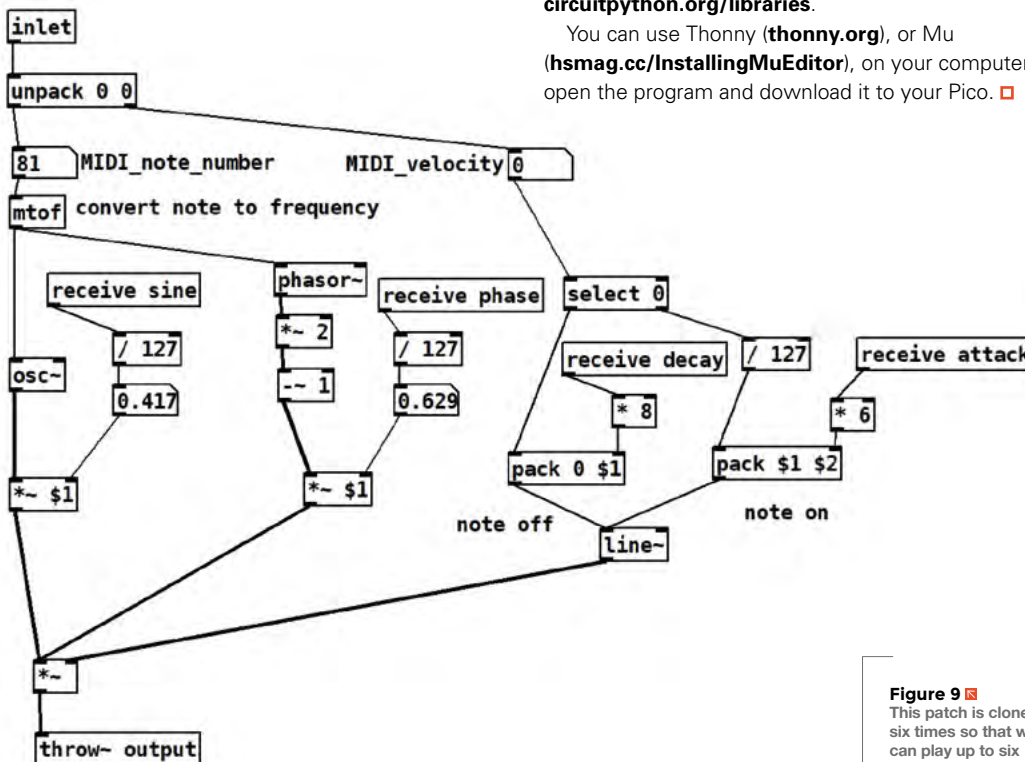

Figure 9 □ This patch is cloned six times so that we can play up to six notes simultaneously

DON'T MISS THE **BRAND NEW** ISSUE!



SUBSCRIBE FROM JUST £5

- **FREE!** 3 issues for the price of one
- **FREE!** Delivery to your door
- **NO OBLIGATION!** Leave any time



**WORTH
£20**

**FREE
PI ZERO 2 W***

With your 12-month subscription to the print magazine

magpi.cc/12months

* While stocks last

Buy online: store.rpiexpress.cc

FIELD TEST

HACK | MAKE | BUILD | CREATE

Hacker gear poked, prodded, taken apart, and investigated

PG
108

RC TRANSMITTER



Make your projects move
with this budget controller

PG
110

RASPBERRY PI ZERO 2 W



The littlest Raspberry Pi
gets a big upgrade

PG
112

THERMAL PRINTER



Creating images
with Bluetooth

PG
102

BEST OF BREED



Networking with Arduino

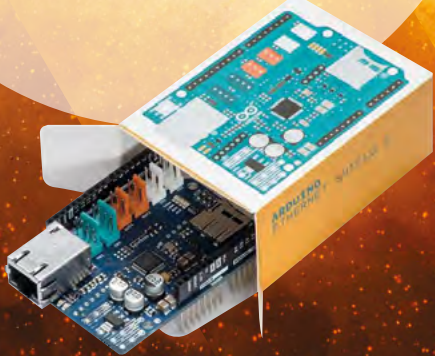

ONLY THE BEST

Wired communications are still alive and well

A selection of Arduino-compatible shields used for wired communications

By Marc de Vinck

 @devinck

W

ired communications are often overlooked now that wireless communications are relatively simple and affordable to implement in your project. But there are

times where wired beats wireless. This is especially true when it comes to the automotive and industrial markets. Many systems still rely on good old-fashioned wires to communicate between machines and computers. Wired communications are typically more reliable, more robust, and can also carry power to remote sensors and devices. And most importantly, so much machinery and technologies that were developed many years prior to wireless technologies are still in service.

In this Best of Breed, I'll be looking at wired communication shields for the classic Arduino ecosystem. Most of us have at least one, if not a lot, of these original form factor Arduinos lying around. And, until doing some research for this roundup, I didn't realise that the idea of the classic shield form factor was falling out of favour so quickly. It seems like everyone has moved to the smaller Feather form factor, myself included. However, the classic-sized shields still exist, and the larger form factor is a

big advantage in these situations as RS232, Ethernet, DMX, and MIDI all have fairly large plugs. So, let's look at what's out there to get your Arduino projects communicating.

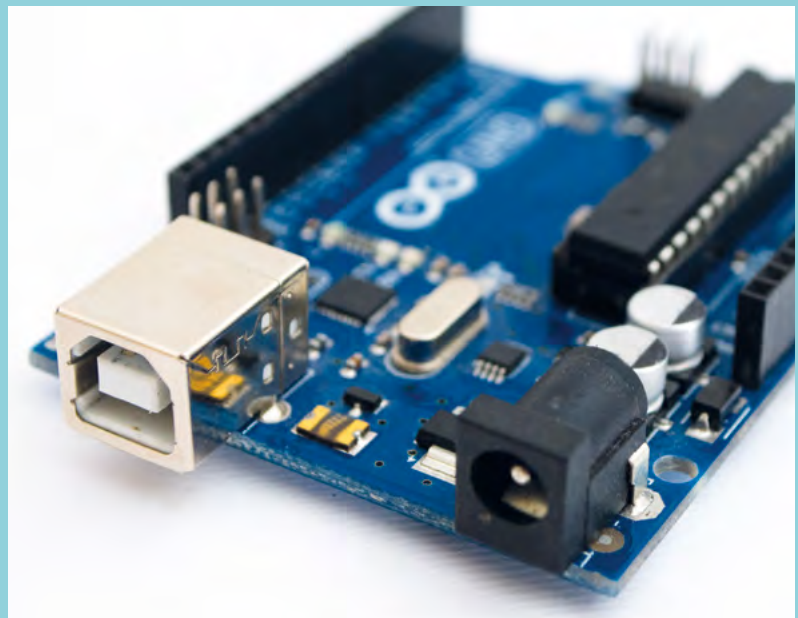

CAN-BUS Shield V2 vs W5500 Ethernet Shield V1

SEED STUDIO ◆ \$27 | seedstudio.com

SEED STUDIO ◆ \$31.90 | seedstudio.com

Hack your car with the **Seeed Studio CAN-BUS shield for Arduino!** OK, maybe not hack it, but at least get meaningful data from your car's computer. The CAN-BUS shield uses the MCP2515 CAN-BUS controller with an SPI interface, and the MCP2551 CAN transceiver to give your Arduino reliable serial communications between your car, or other industrial controller.

What makes this shield a good choice is the added connectors and accessories. There is a standard DB9 connector, a quick connector interface, an SD card slot, and two Grove connectors for adding plug-and-play sensors and displays. The website also has a good introduction to the CAN-BUS system, and how you can tap into all the data that is available in your car. Just take note that this is not a plug-and-play solution with an OBD-II connector, but you can easily add that as needed, since the shield supports selectable OBD-II and CAN standard pinouts.

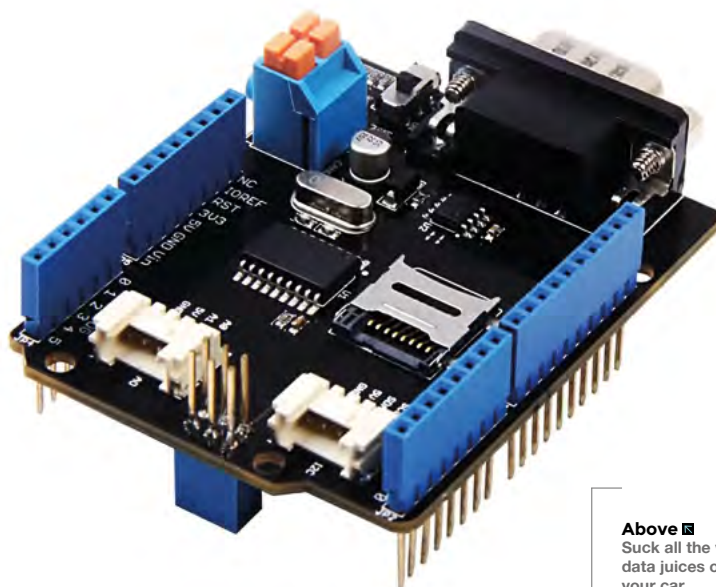

Above Suck all the valuable data juices out of your car

VERDICT

CAN-BUS
Shield V2

Well-documented
CAN-BUS shield.

9/10

W5500 Ethernet
Shield

A classic
communication
protocol that is
executed well.

10/10

It's hard to go wrong with the reliable and ubiquitous Ethernet communications protocol, and that's where the **W5500 Ethernet Shield from Seeed Studios** comes into play. It features the same functionality as the official Arduino Ethernet shield, but with a newer chipset. This shield supports TCP and IP protocols in UDP, ICMP, IPv4, PPPoE, ARP, and IGMP. And unlike most other Ethernet shields on the market, this board's RJ45 port is mounted low enough to enable you to stack another shield on top. The board also features a microSD card slot and Grove connectors for added functionality. And, most importantly, the shield works well with the Ethernet library, so getting up and running is simple. Head over to the product page for more information. →



Above Plug an Arduino into your LAN



BEST OF BREED

RS232 Shield

SEED STUDIO ♦ \$12.70 | seedstudio.com

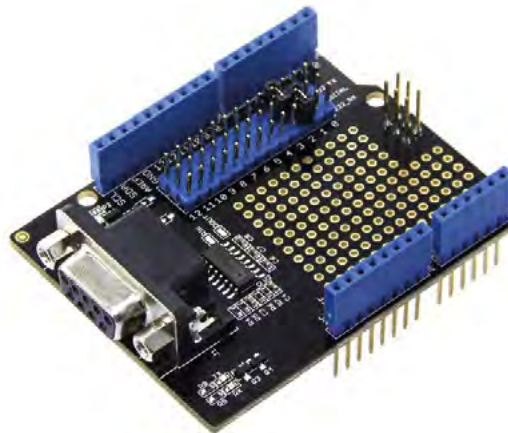

The RS232 Shield from Seeed Studio features the standard DB9 communication port for communicating with industrial equipment. The shield features a MAX232 microcontroller, with a dual driver and receiver that includes a capacitive voltage generator to supply the industry standard TIA/EIA-232-F voltage levels from a single 5V supply. You also get a small prototyping area for added electronics, as needed for your project. If you have a piece of equipment that uses RS232 for communications or control that you'd like to modernize, hack, or repurpose, then you should take a look at this affordable and easy-to-use shield.

Left ▣
Add a modern interface to your retro equipment

VERDICT

RS232 Shield

A good solution if you use RS232.

8/10

FREEMATICS OBD-II UART ADAPTER V2.1

FREEMATICS ♦ \$44.80 | freemantics.com

When you just want to grab some data from your car's OBD-II port and send it over to your Arduino, then the Freemantics OBD-II UART Adapter might be a perfect solution. It acts as a data bridge between a car's OBD-II port and your Arduino. It allows for high-speed data access to your car's information. It also features an integrated 9-DOF motion sensor with built-in sensor fusion algorithm. There's a lot going on with this adapter, so head over to the product page to learn about all the commands you can send and receive, along with sample Arduino code.



Arduino Ethernet Shield 2

ARDUINO ◆ \$24.80 | store-usa.arduino.cc

Designed and sold by the Arduino team themselves, the Arduino Ethernet Shield 2 can get you connected to the internet in a matter of minutes. Simply add this shield to your standard Arduino board, add a standard RJ45 cable, and with just a few adjustments to the code, you'll be connected to the world. And unlike wireless communications, this one is robust and isn't as prone to interference.

In addition to the RJ45 plug, the V2 version of the shield also has a microSD card slot and is compatible with more Arduino boards. If you need a hardwired connection to the internet, or just need a simple way to integrate longer distance communications, then you should check out this easy-to-implement shield. →

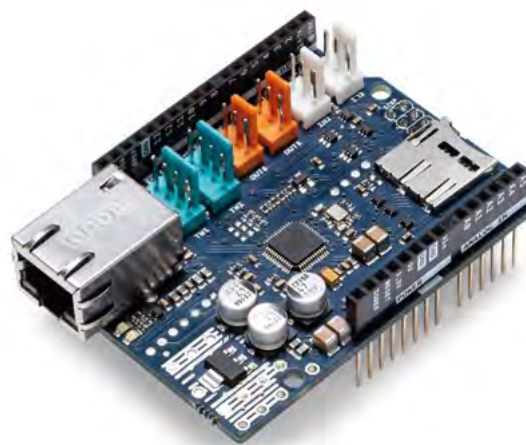

VERDICT

Arduino Ethernet Shield 2

Affordable Ethernet for your classic Arduino.

9/10

“

With just a few adjustments to the code, you'll be connected to the world

”

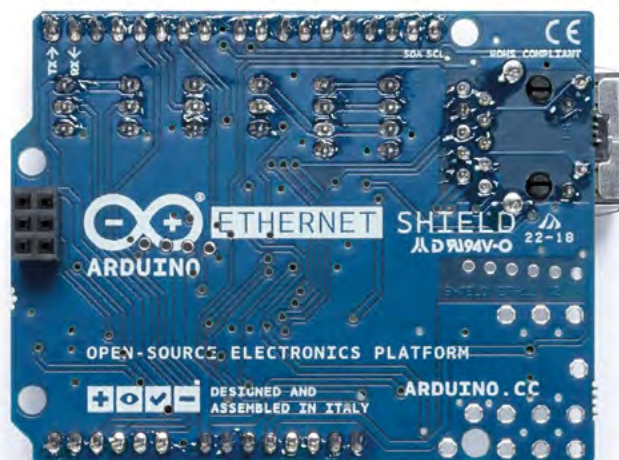

Above ◆
Get on line the official way

2.5kV Isolated DMX 512 Shield for Arduino - R2

CONCEPTINETICS [\\$44.95](#) | [tindie.com](#)

There are many different types of wired communication out there, including DMX. And for those of you unfamiliar with this protocol, it's basically a standard for controlling commercial lighting controllers. And since there are so many lighting projects out there in the DIY community, we thought we should include a shield in this roundup. We're not going to go into depth about the difference between DMX and XLR cables, as there is some overlap, and it gets complicated quickly. All you need to know is that this particular shield is available in 3-pin XLR or 5-pin XLR, and if that's what you need, then take a look at this shield. [□](#)

Right [□](#)
Lights! Camera!
Action!

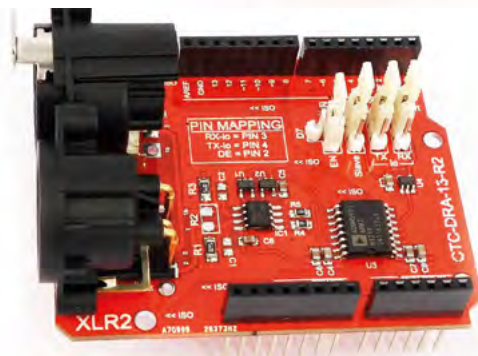

VERDICT

2.5kV Isolated DMX 512 Shield for Arduino - R2

Multiple options makes this a great choice.

9/10

SPARKFUN MIDI SHIELD

SPARKFUN [\\$21.95](#) | [sparkfun.com](#)

And how can we forget about MIDI? That's a wired communication protocol that was developed back in the early 1980s, and is still used extensively today. If you are into music, and would like to tap into your MIDI network safely and with optoisolated MIDI-IN and MIDI-OUT, then pop your collar, grab those high-tops, and head over to SparkFun to learn more about their MIDI Shield for Arduino. And if you are making 1980s synth music, please share it with us!

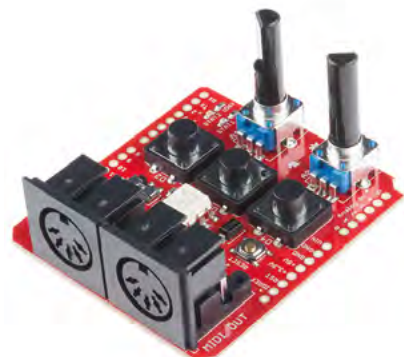

Wireframe

Join us as we lift the lid
on video games



Visit wfmag.cc to learn more

Jumper T-LITE Multi-protocol RC transmitter

Adding buttons without wires

JUMPER RC ♦ £65 | jumper-rc.com

By Jo Hinchliffe

@concreted0g

Radio control (RC) transmitters can be large and bulky items, and that's great if that's what you are used to.

If you are more accustomed to using game console controllers, then there are increasing numbers of transmitters available using that form factor. We decided to take a look at a popular one that we feel has a lot of crossover from radio control into other, perhaps more HackSpace-y, areas of interest.

Below ♦

The Jumper T-LITE is powered by a 18650 battery, which is not provided. Once installed correctly, you can charge the 18650 battery via the USB-C connector

The Jumper T-LITE is available for around £65 and is a 16-channel multi-protocol transmitter running OpenTX. Don't worry if you don't understand what that means – we'll explain as we go on. Firstly, let's look at the 'multi-protocol'. Within RC systems there are multiple radio families, and the Jumper T-LITE works across a wide range of them. It has a 4-in-1 radio module, which actually means it physically has four separate radio chips inside it, and the firmware enables each of those chips to work with multiple radio protocols. This means that, not only do you have a vast choice of receivers that are compatible to buy and incorporate into your project, but also that the T-LITE will bind to many off-the-shelf models. For example, we have used this controller with a small Eachine RC plane and a Syma X11 quadcopter. Furthermore, in the box, you also get an adapter that allows you to add other available radio modules externally, increasing its already large compatibility.

The T-LITE needs to be powered by a 18650 battery (not included). There are warning stickers telling you that you need to be sure that you install the battery the correct way around, as if you reverse the polarity, you will damage the unit. While this is easily avoided, it definitely loses a mark for not adding some simple polarity protection to the design. Once your 18650 is installed, it can be charged internally using the USB-C connector on the device. You can also use the USB-C port to connect the device to a computer to use as a simulator controller.





Turning the unit on, you are greeted with the bright, backlit monochrome screen showing the OpenTX boot screen. OpenTX is an open-source project creating an incredibly powerful and configurable firmware that works on a variety of transmitters. We don't pretend to be experts in OpenTX, but it's pretty easy to do the basics with it on the Jumper T-LITE.

Setting up a new model profile, assigning switches to channels, reversing channels, and other common model setup tasks are mostly intuitive and require only a little reading around. The Jumper T-LITE also has a microSD card slot (you need to supply your own SD card), which is useful in terms of easily performing OpenTX firmware updates. A quick trip to the Jumper T-LITE web page also allows you to download additional content to put on your SD card. This includes sound and voice files that enable OpenTX to speak to you and give you verbal feedback about the transmitter and connected device. This can be a really handy feature. For example, you can have the radio say 'Armed', 'Disarmed', or indeed with a little research, you can swap out sound files and have your Jumper T-LITE play the *Thunderbirds* theme tune, or whatever you like!

Delving further into OpenTX, there are numerous projects creating companion tools to help you organise and program your transmitter; there are also heaps of features that we are yet to explore. We also



note that OpenTX is capable of executing Lua scripts based on transmitter triggers, so it seems that there are endless possibilities of what functions you could assign to one of the Jumper T-LITE switches.

In use, we found the Jumper T-LITE to be comfortable in hand, and that the control gimbals are excellent and smooth in all areas. We also found the switch positions to be OK and usable, but wondered if someone with larger hands and thicker fingers might find them a bit too close together. We love the size of the transmitter; it's easily slung into a small case with a drone, plane, or robot. The only real loss over a larger transmitter style, in our opinion, is that it uses a smaller screen. □

Above ♦ Arriving well-packed, the Jumper T-LITE has a USB-C cable, a 18650 battery storage box, an external radio module caddy, and some stickers!

Left ♦ The Jumper T-LITE can connect to a wide variety of radio receivers, including many toy-grade radio protocols

VERDICT

This slick, small controller has masses of useful functions, is compatible with a wide range of radio systems, and feels good in the hand.

9/10

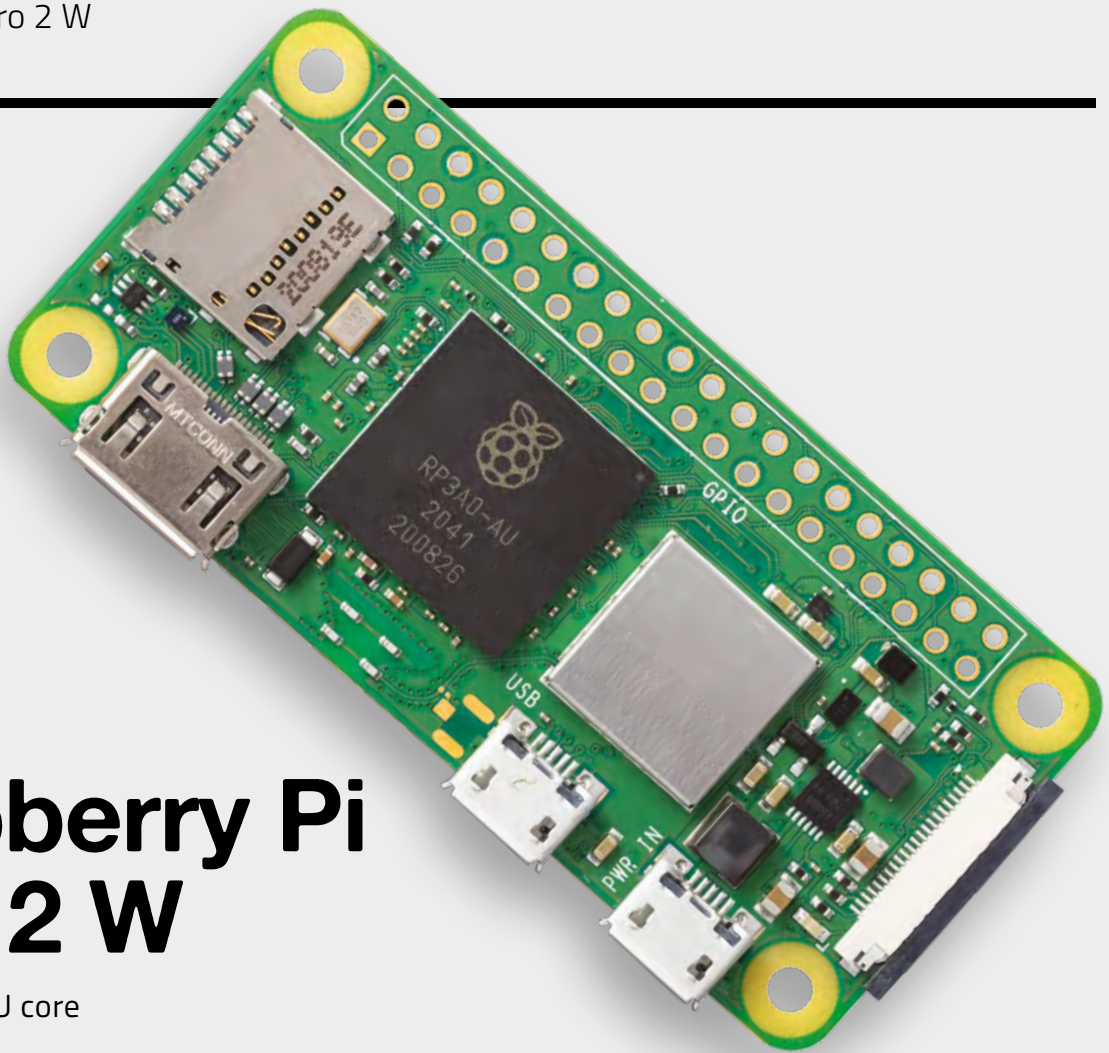

Raspberry Pi Zero 2 W

Under \$4 per CPU core

RASPBERRY PI ♦ \$15 | raspberrypi.com

By Ben Everard

@ben_everard

In February 2012, Raspberry Pi launched its first computer, based on the BCM2835 system on a chip. A lot has changed in the

intervening nine years, but the little BCM2835 has remained in the Raspberry Pi line-up. After the Raspberry Pi 2 supplanted version 1 in 2015, the BCM2835 lived on in the Raspberry Pi Zero (and later the Zero W). It's continued to power projects big and small, providing cheap access to computing around the world. However, after nine years of service, is it time to let this little chip slip into a dignified retirement (though the original Zero will still be available)?

The Raspberry Pi Zero 2 W is a pin-compatible replacement for the original Zero (or Zero W), that brings in a significant boost in processor performance. The BCM2710 silicon die (which particularly avid Raspberry Pi watchers will recognise from the Raspberry Pi 3), brings in four cores running at 1GHz. The single-core performance is about 40% up, and

with four of them, any multi-threaded workload will see a significant uplift. You might even be able to get a bit more speed out of it if you add a cooling system.

Alongside this, there are the same features that we know and love from the original Zero: 512MB of RAM, microSD card, Mini HDMI, USB 2.0 OTG, micro HDMI, micro USB (for power), Raspberry Pi standard 40-pin header, and camera connector. In other words, if you can connect a thing to an original Zero, you can connect it to the Zero 2 W and get added processor power.

As you would expect from Raspberry Pi, the software upgrade should be seamless. Raspberry Pi OS will work as expected. In fact, if you have a reasonably recent version of the operating system running on another Raspberry Pi Zero (or other model), you can simply take the SD card out, pop it in a Zero 2 W, and you should be up and running. Other operating systems should also work.

Above  The form factor is unchanged, so you can drop this into your Zero projects

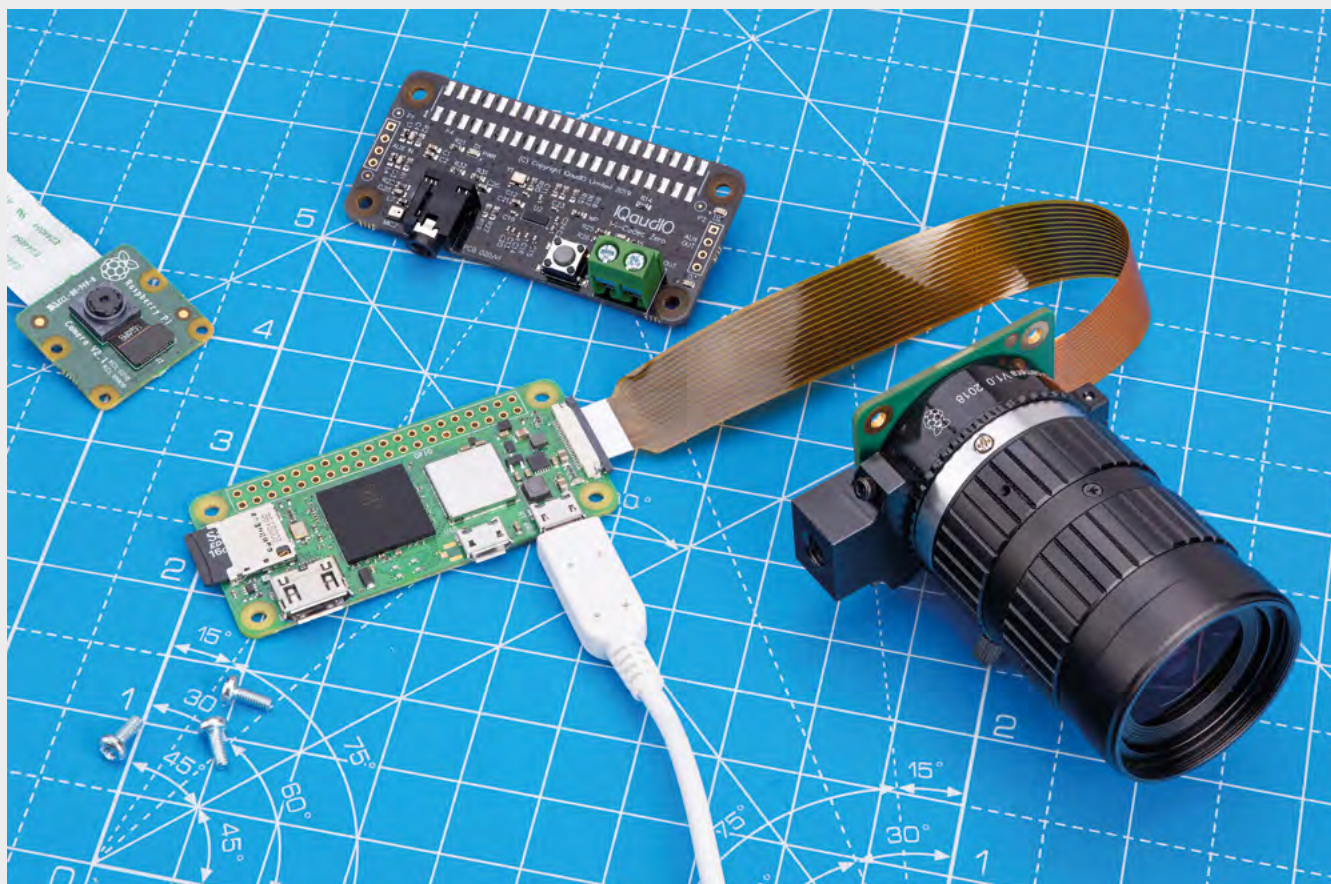

This is a whole heap more performance, but what does this mean in use? Obviously if you're using a Zero as a desktop, upgrading will make a huge difference to day-to-day use, but a large number of Zeros are embedded in projects. The small size and price makes this little board great for adding processing power to – well, just about anything. While the speed boost will be great for all users, there are a few areas that we think will particularly benefit from the extra speed.

Machine learning – such as TensorFlow – can add features such as object recognition to cameras, but is a CPU hog. The added processor power will be a huge boost for these, and should mean more complex models can run in real time.

The small size of the Zero makes it a popular choice for handheld gaming, and the added

processing power will mean more games will run. Added to this is the fact that it's the same form factor and it's a drop-in speed-boost for gamers.

The speed-up – and particularly the extra processing cores – means that the Zero can do more in parallel, such as hosting a web interface and

controlling hardware, which are two tasks that 3D printer-controller OctoPrint needs to do. While the original Zero wasn't recommended for OctoPrint, the new Zero 2 W works well and is supported.

While the original Zero wasn't recommended for OctoPrint, the new Zero 2 W works well and is supported

After six years, the Zero is long-due an upgrade. The new Zero 2 W keeps the small size and form factor of the original Zero, and boosts the performance. This big leap in performance brings both a bit more slickness to the desktop, and a whole lot more possibilities for projects. We're looking forward to seeing what you all build with it. □

Above □ The extra processing power of the Zero 2 W is great for working with large images

VERDICT

The tiny Raspberry Pi gets a big speed increase.

10/10



Bluetooth 'cat' thermal printer

For when a document says "Print meow-t"

HAND MINI ♦ £16 | [aliexpress.com](https://www.aliexpress.com)

By Jo Hinchliffe

 @concreted0g

Thermal printers have been the go-to technology for small, cheap, low-resolution yet reliable printing, till receipts being the most obvious use and, in years gone by, desktop calculators.

It was perhaps the fact that thermal printers became available, back in the day, as a Game Boy accessory that piqued the interest of a generation of hardware hackers. Cut to today, and there are lots of stand-alone thermal printers that are available to connect to all kinds of devices for us to tinker with.

At the budget end of this market are very cheap, Bluetooth-enabled thermal printers which don't appear to have a technical model number or company name. Rather, they are referred to as the animal depicted on the plastic enclosure. We opted for the 'cat' thermal printer, which arrived well-packed with a roll of paper for £16.

The printer has an internal battery, which needs charging via a micro USB cable (included). Once charged, a single button press (there is only one button) turns the unit on. Double-pressing the button causes the printer to print a test page that features a QR code and some details, including the device Bluetooth name and the pairing PIN.

Trying to scan the QR code the printer created, our Android phone failed to read it. We presumed that the QR code would be linking to an app for installation, so this left us scratching our heads as to how to use the printer. A quick search online revealed that we were not the only ones to have this issue, and we discovered that the app we needed to install was the 'WalkPrint' app available on Google Play.

Above ♦
The 'Cat' bluetooth thermal printer; we've also seen 'pig' and 'panda' variants out in the wild!



Using the pairing PIN provided, we connected to the printer with ease and launched the application. The application is full of flaws and typos, but functionally works to allow you to send images and text to the printer. It has a range of features, including various note-taking and list-making sections where you can add text over preset list designs. There are stacks of randomly collated areas in the app full of sticker designs and anime characters, and more. Of course, you can also just send an image or photo from your device to the printer. We also found that the 'Banner' section of the app allows you to create longer prints with oversized text – while this worked well, we were unsure which occasion calls for a tiny, cheaply printed banner, but never say never!

We couldn't work out a way to share text from other apps to the WalkPrint app, but we did find that the usual copy and paste Android functions for text worked well, allowing you to copy text from elsewhere into a new note. It's possible, within a WalkPrint 'note', to add text, clip art images, and photographs and arrange them in the print area. While you probably aren't going to publish a book on it, it's fun to play with and works well. You can also save print jobs as native files within WalkPrint, so you can store a commonly used image or template in the app itself. Handy if you wanted to do print-on-demand contact slips at an event, for example.

We noticed an issue in that our usual preference is to have our phone running in dark mode – a black background with white text – as the normal state. In the app, this meant that everything printed as such, with a dark background; however, flipping to light mode temporarily when using the app rectified this problem.



Swapping rolls of paper is straightforward – simply press a large button on the side, and the front of the printer pops open, revealing the roll area. The roll sits inside with the paper fed out through the opening, and the pressure of the print head rollers pulls the paper through when printing. The rolls of paper are 57mm wide and 30mm in diameter – these are widely available; there are also sticker material rolls available in this size.

It's quite fun to be able to print out and share images on the go, and also occasionally useful to share a note or print a to-do list. We imagine those who are into creating scrap-books or journaling might find this a useful and fun printer, as it stands, with no modification. However, researching this particular printer reveals that there are numerous projects and repositories where people have got this little printer hooked up to other microcontrollers. If you are an Arduino IDE user, then Larry Bank has created an incredibly useful library (hsmag.cc/catprint) – this means that an Arduino or perhaps an ESP32 thermal printer project is well within reach. We were also interested to see that Adafruit has a tutorial by Jeff Epler looking at driving this very printer with CircuitPython using the Adafruit CLUE platform. As the CLUE platform is running CircuitPython, it's probably only a hop and a skip away from getting this printer up and running with a Raspberry Pi Pico.

All in all, a lot of tech to play with on a lot of levels for not very much money. □

Above ♦ Again, the text is clear and legible – there are options to change the font size, underline, italicise, and more

Left ■ Changing the paper reel is as simple as lifting the lid and dropping one in

VERDICT

As it is, it prints reliably, albeit with a slightly clunky Android application – as a platform for projects, it's a great piece of kit.

8/10

issue

#50

ON SALE
16 DECEMBER

MACHINE LEARNING

ALSO

- CHRISTMAS BUILDS
- CIRCUITPYTHON
- 3D PRINTING
- PCBS
- AND MUCH MORE

DON'T MISS OUT

hsmag.cc/subscribe

next month

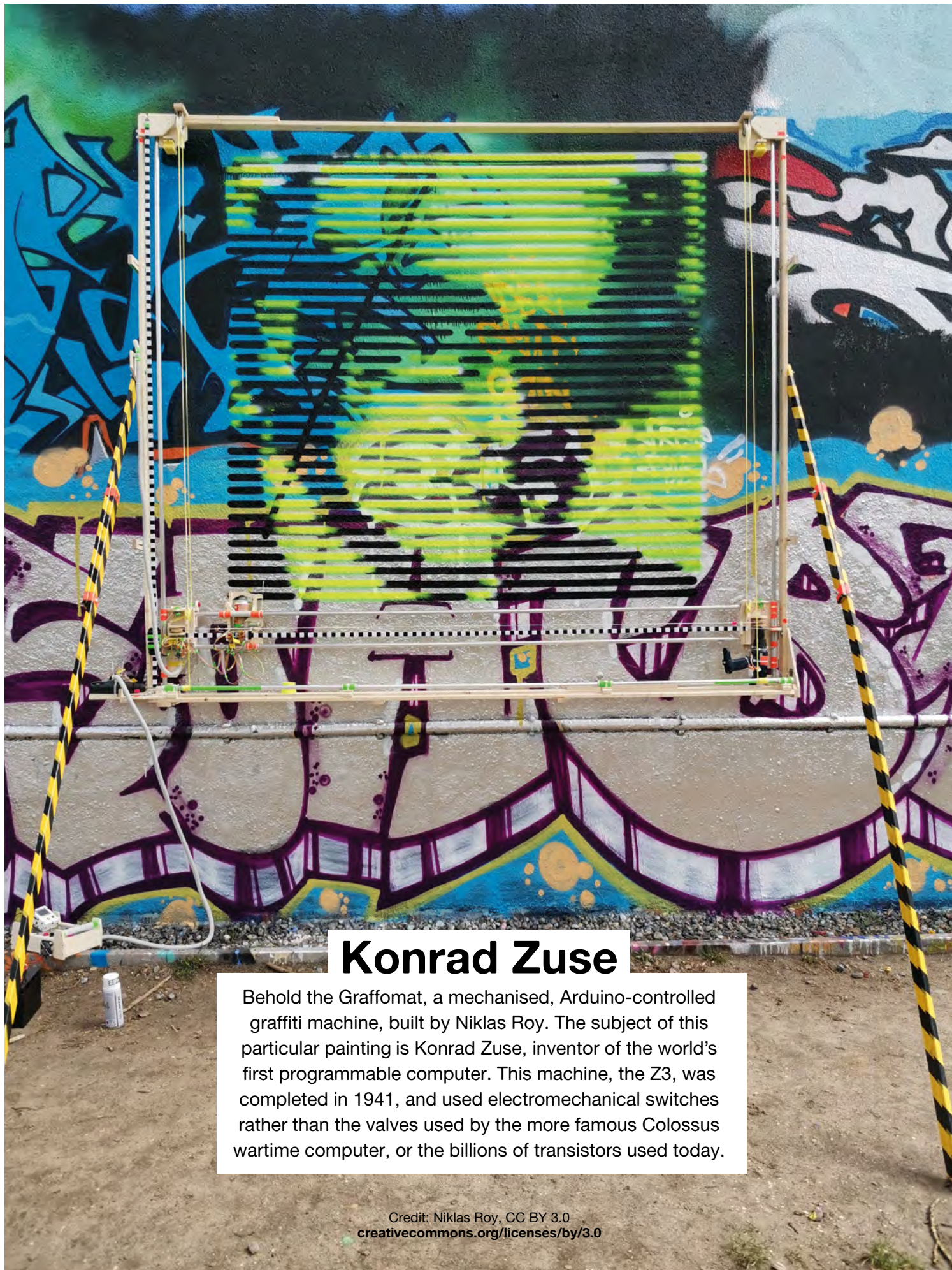

Konrad Zuse

Behold the Graffomat, a mechanised, Arduino-controlled graffiti machine, built by Niklas Roy. The subject of this particular painting is Konrad Zuse, inventor of the world's first programmable computer. This machine, the Z3, was completed in 1941, and used electromechanical switches rather than the valves used by the more famous Colossus wartime computer, or the billions of transistors used today.

HS