

MAKE | BUILD | HACK | CREATE

USA OFFER  
12 issues  
for \$60  
hsmag.cc/usa

# HackSpace

TECHNOLOGY IN YOUR HANDS

hsmag.cc

April 2020

Issue #29

## FIGHTING ROBOTS

We test out a self-build kit

## GAMES CONTROLLER

Get your games interacting with the real world

## Men's sheds

Charlie Bethel on tea, wellbeing and why your shed needs you



# MAKE WITH WOOD

Pick the right tools

Master the materials

Build something useful

Arduino Displays

Testing NeoPixels

Recycling plant pots

Raspberry Pi skills

## BETTER 3D PRINTS

Top tips for perfect prints (almost) every time

## AUTOMATIC HEATING

Keep your workshop at the right temperature



Apr.2020  
Issue #29 £6

PLAYING CARDS BUNNIES LITHOPHANES MUSIC



# The Building Blocks for Your Next Innovation

Hardware

Interconnects

Wireless & RF

Power

Industrial Automation

Semiconductors

Electromechanical

IoT

**Digi-Key**<sup>®</sup>  
ELECTRONICS

Sensors

Passives

Dev Boards

**FREE  
SHIPPING**  
ON ORDERS OVER  
£33 OR \$50 USD\*



0800 587 0991

**DIGIKEY.CO.UK**

8.9 MILLION+ PRODUCTS ONLINE | 800+ INDUSTRY-LEADING SUPPLIERS | 100% FRANCHISED DISTRIBUTOR

\*A shipping charge of £12.00 will be billed on all orders of less than £33.00. A shipping charge of \$18.00 USD will be billed on all orders of less than \$50.00 USD. All orders are shipped via UPS, Federal Express, or DHL for delivery within 1-3 days (dependent on final destination). No handling fees. All prices are in British pound sterling or United States dollar. Digi-Key is a franchised distributor for all supplier partners. New products added daily. Digi-Key and Digi-Key Electronics are registered trademarks of Digi-Key Electronics in the U.S. and other countries. © 2020 Digi-Key Electronics, 701 Brooks Ave. South, Thief River Falls, MN 56701, USA

ECIA MEMBER  
Supporting The Authorized Channel





# Welcome to HackSpace magazine

I'm not very good at woodwork. I just kind of muddle through, which is fine when you don't have to make anything too strong. However, I really like the look of well-made wooden items, and would love to have a few more personalised bits around the home. I don't feel the need to throw myself into fine woodworking (much as I envy those with these skills), but build well enough to show off the look of this natural material. This month we're looking at helping people like me who want to take the step beyond 'bodging it together', and start making things that look good. I'm looking forward to putting these skills to good use in the coming months. Now I think of it, it's the perfect time to start work on some garden furniture – it should be ready by the time the weather warms up.

Of course, we haven't abandoned the electrons this issue, and we've got a great range of digital making, including fighting robots (page 128), 3D printing (page 92), and possibly the most illuminating bin in the world (page 52). Whatever form of making you enjoy, we've got something for you. Turn the page for your monthly dose of inspiration, skills, and reviews.

## BEN EVERARD

Editor [ben.everard@raspberrypi.org](mailto:ben.everard@raspberrypi.org)

Got a comment, question, or thought about HackSpace magazine?

get in touch at [hsmag.cc/hello](mailto:hsmag.cc/hello)

## GET IN TOUCH

[hackspace@raspberrypi.org](mailto:hackspace@raspberrypi.org)

[facebook.com/hackspacemag](#)

[twitter.com/hackspacemag](#)

## ONLINE

[hsmag.cc](http://hsmag.cc)



PAGE **50**  
SUBSCRIBE TODAY

## EDITORIAL

### Editor

Ben Everard

[ben.everard@raspberrypi.org](mailto:ben.everard@raspberrypi.org)

### Features Editor

Andrew Gregory

[andrew.gregory@raspberrypi.org](mailto:andrew.gregory@raspberrypi.org)

### Sub-Editors

David Higgs, Nicola King

## DESIGN

### Critical Media

[criticalmedia.co.uk](http://criticalmedia.co.uk)

### Head of Design

Lee Allen

### Designers

Sam Ribbitts, Harriet Knight, Ty Logan

### Photography

Brian O'Halloran, Paul Carroll

## CONTRIBUTORS

Lucy Rogers, Drew Fustini, Jo Hinchliffe, Norman Pirollo, Daren Tarbard, Mayank Sharma, Andrew Lewis, Glenn Horan, PJ Evans, Gareth Branwyn, Les Pounder, Marc de Vinck

## PUBLISHING

### Publishing Director

Russell Barnes

[russell@raspberrypi.org](mailto:russell@raspberrypi.org)

### Advertising

Charlie Milligan

[charlotte.milligan@raspberrypi.org](mailto:charlotte.milligan@raspberrypi.org)

## DISTRIBUTION

Seymour Distribution Ltd

2 East Poultry Ave,  
London EC1A 9PT

+44 (0)207 429 4000

## SUBSCRIPTIONS

Unit 6, The Enterprise Centre,  
Kelvin Lane, Manor Royal,  
Crawley, West Sussex, RH10 9PE

### To subscribe

01293 312189

[hsmag.cc/subscribe](http://hsmag.cc/subscribe)

### Subscription queries

[hackspace@subscriptionhelpline.co.uk](mailto:hackspace@subscriptionhelpline.co.uk)



This magazine is printed on paper sourced from sustainable forests. The printer operates an environmental management system which has been assessed as conforming to ISO 14001.

HackSpace magazine is published by Raspberry Pi (Trading) Ltd., Maurice Wilkes Building, St. John's Innovation Park, Cowley Road, Cambridge, CB4 0DS. The publisher, editor, and contributors accept no responsibility in respect of any omissions or errors relating to goods, products or services referred to or advertised. Except where otherwise noted, content in this magazine is licensed under a Creative Commons Attribution-NonCommercial-ShareAlike 3.0 Unported (CC BY-NC-SA 3.0). ISSN: 2515-5148.



# Contents

126

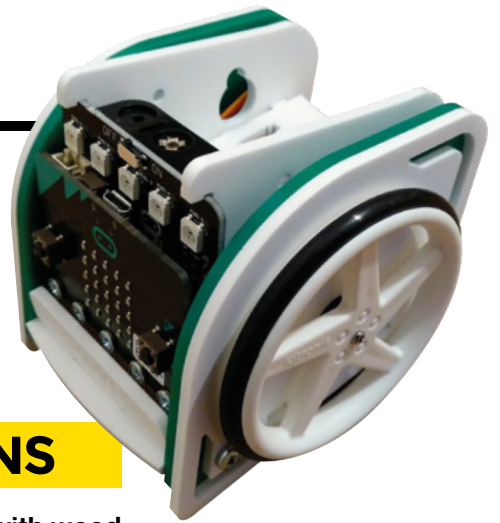

06

## SPARK

- 06 Top Projects**  
Smart things, made by smart people
- 16 Objet 3d'art**  
Save the trees – make guitars from plastic instead
- 18 Cool build: paper plane**  
The end-of-level boss of paper planes
- 22 Columns**  
How to replace (most of) your toolbox with a phone
- 24 Letters**  
Schrödinger's Python: both compiled and interpreted
- 26 Kickstarting**  
Orange Crab: an FPGA in a Feather form factor
- 28 Hackspace Dundee Makerspace**  
Making in the home of jute, jam, and journalism

33

## LENS

- 34 Make with wood**  
Get started with the tools and the materials of woodworking
- 52 How I Made: BinDayCator**  
Our favourite IoT computer-to-human interface yet
- 58 In the workshop: Lithophanes**  
Shine a light through 3D-printed plastic
- 62 Interview: Men's Sheds**  
We chat well-being, making, and looking after yourself
- 70 Improviser's Toolbox** Playing cards  
Mystical divination tool or maker material? You decide!
- 74 NeoPixel voltages**  
Breaking all the rules with a multimeter

## Cover Feature



Take your first steps  
down the rabbit hole  
of woodworking

34

## Tutorial

### School of making: Dividing



**82** The power of maths compels you to work out correct angles

26

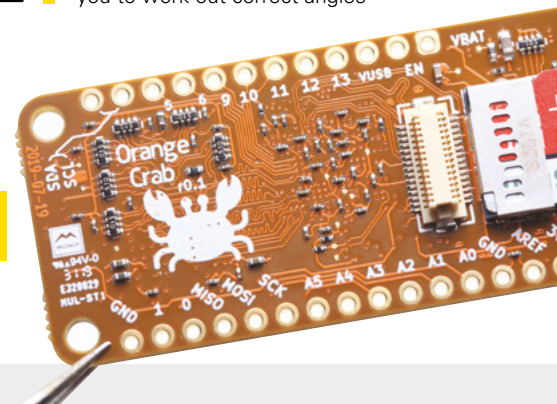





122

Direct from Shenzhen

Endoscope



114

Slip inside the eye of your mind an electronics enclosure

77

FORGE

- 78 **SoM CircuitPython**  
Add a text output to a CircuitPython device
- 82 **SoM Dividing**  
It's easy with a calculator; harder on a lathe
- 88 **SoM LED displays**  
Make your build more informative with a screen
- 92 **Tutorial Maker tips**  
Weird and wonderful ways to improve your prints
- 96 **Tutorial Shed heater**  
Build a thermostat IoT heating system
- 100 **Tutorial 3D printing**  
Design and print a herb garden. Aslan is coming!
- 106 **Tutorial Air quality monitor**  
Use open data to protect your soft, pink lungs
- 110 **Tutorial Level shifters**  
Help different devices speak the same voltages

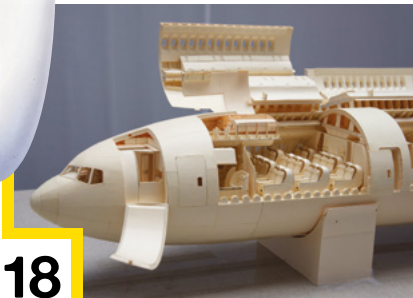

18

Interview

Charlie Bethel



62

Why making is the therapy that dare not speak its name

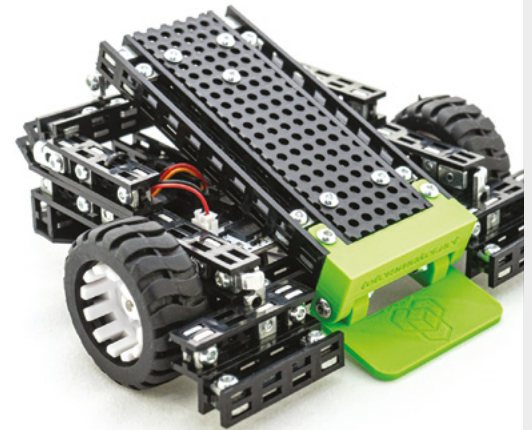

128



06

113

FIELD TEST

- 114 **Direct from Shenzhen Endoscope**  
Look into nooks and crannies with a 0.3 megapixel scope
- 116 **Best of Breed**  
The best cases to protect your Raspberry Pi
- 122 **Can I Hack It?**  
Glory in the nostalgia as we hack an Xbox 360 controller
- 124 **Review Pimoroni Fan SHIM**  
Cool the molten core of your Raspberry Pi 4
- 126 **Review Kitronik :MOVE mini MK2**  
Accessible robotics on a micro:bit
- 128 **Review Totem Mini Trooper**  
A fighting robot kit to build at home

Some of the tools and techniques shown in HackSpace Magazine are dangerous unless used with skill, experience and appropriate personal protection equipment. While we attempt to guide the reader, ultimately you are responsible for your own safety and understanding the limits of yourself and your equipment. HackSpace Magazine is intended for an adult audience and some projects may be dangerous for children. Raspberry Pi (Trading) Ltd does not accept responsibility for any injuries, damage to equipment, or costs incurred from projects, tutorials or suggestions in HackSpace Magazine. Laws and regulations covering many of the topics in HackSpace Magazine are different between countries, and are always subject to change. You are responsible for understanding the requirements in your jurisdiction and ensuring that you comply with them. Some manufacturers place limits on the use of their hardware which some projects or suggestions in HackSpace Magazine may go beyond. It is your responsibility to understand the manufacturer's limits.





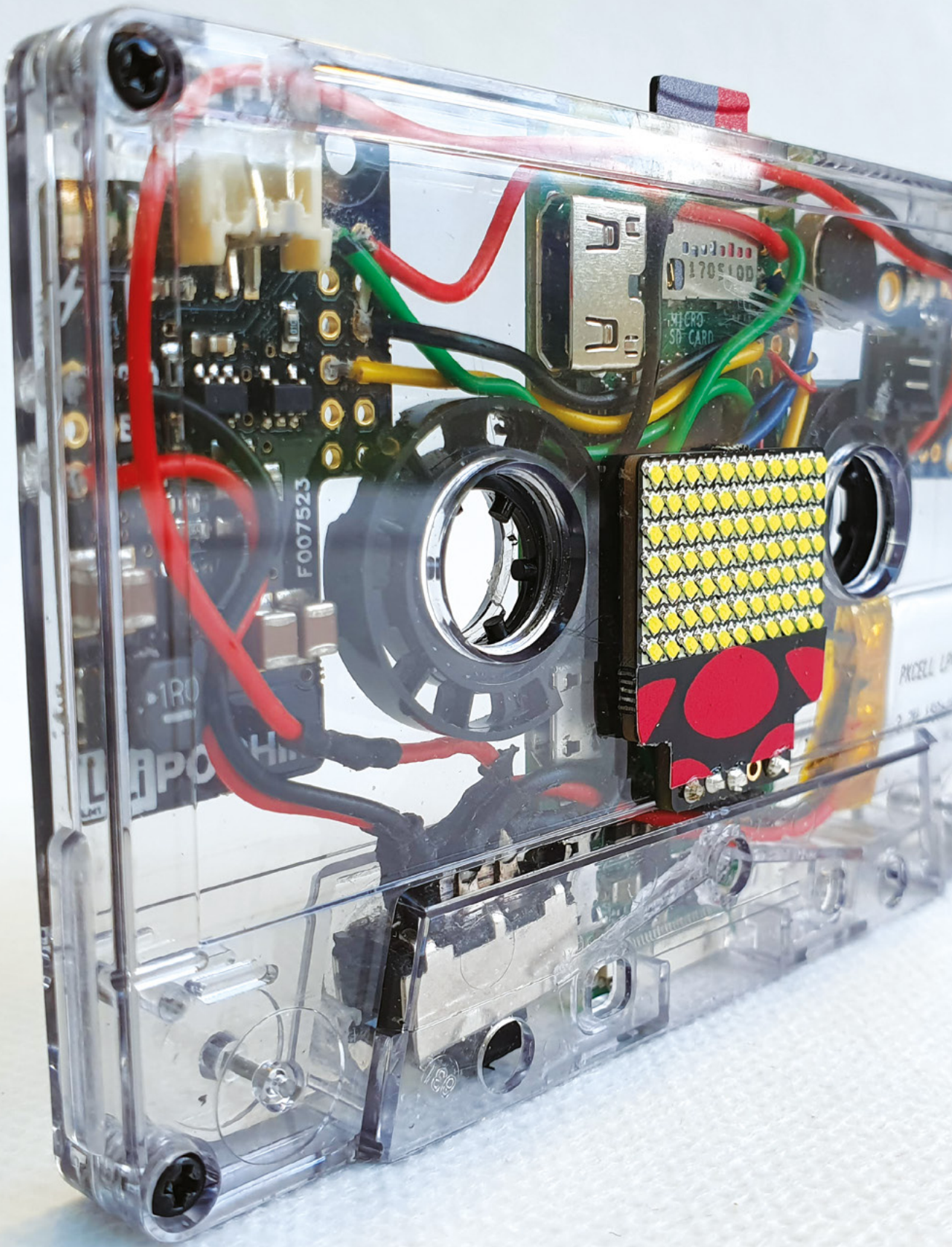



# Cassette scroller

By Martin Mander

[kyliemander.com](http://kyliemander.com)

**M**artin Mander, aka Old Tech. New Spec, gives life to obsolete technologies, usually by sticking a computer in them and connecting them to the internet. In this example of the upcycler's craft, he's turned a cassette (an ancient, rubbish way of recording music) into an IoT notification reader.

The thing is powered by a Raspberry Pi Zero W powered by a 150mAh LiPo battery via a Pimoroni LiPo SHIM. There's an Adafruit Micro-Lipo in there to make recharging possible, and notifications are displayed on an 11x7 LED matrix.

Software-wise, Martin's used the IFTTT service to grab updates from the internet, and Adafruit IO and a bit of Python to make the notifications appear on the screen. It's a simple project, masterfully done. □



**Left** □  
 Finally! A use for our obsolete Now That's What I Call Music... collection



# Charliewatch

By Trammell Hudson

[hsmag.cc/d1odGi](https://hsmag.cc/d1odGi)

**In the rush to digitisation, we've lost something immediate about analogue interfaces.** Numbers need a moment to parse, dials have to be read and understood, rather than just glanced at. That's not so with Trammell Hudson's Charliewatch, based on Travis Goodspeed's GoodWatch21 schematic. It uses 72 surface mount LEDs to tell the time, just like an analogue clock-face. It's so simple, we feel a bit silly explaining it: you can clearly see that it has 60 LEDs instead of a minute hand, and twelve LEDs to denote the hour hand. And the name? That comes from Charlieplexing, which is how the LEDs are chained together. ▣

**Right** ▣  
After a year of use,  
the Charliewatch  
has consumed two  
CR2032 batteries

**Credit**  
CC-BY Trammell Hudson



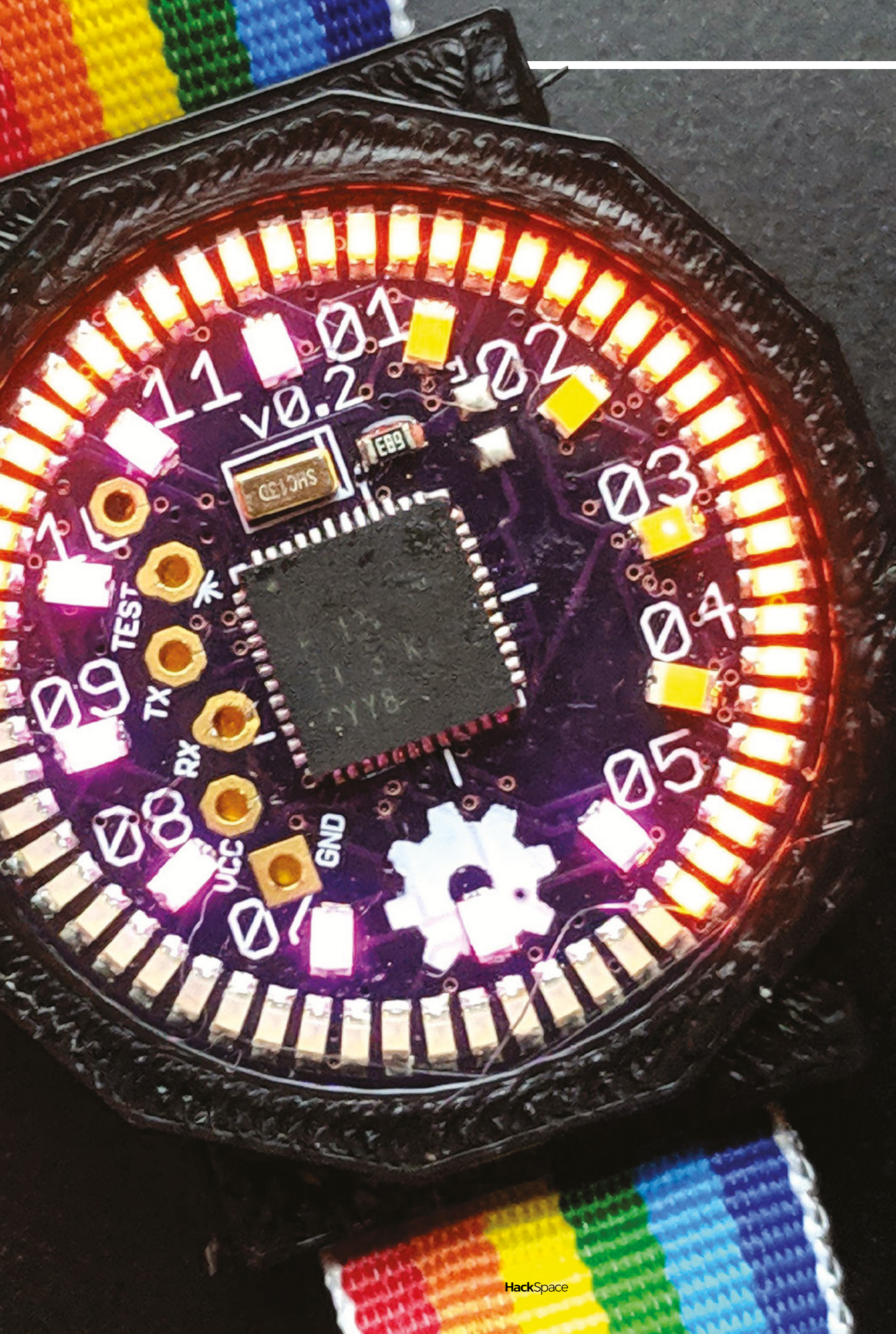



# Computer bugs

By Julie Alice Chappell

[hsmag.cc/qT0TUK](https://hsmag.cc/qT0TUK)

**M**y love of nature and art coincide in my tiny sculptures which I call, 'Computer Bugs'. I find art to be a free-flowing and abstract way in which to consider the natural world.

Insects are the main subject of my work, but also the genius of humankind's technological advances as seen in the ever-increasing leaps forward in computer technology. The downside to this technology is capitalism's insistence in profits over limited resources, resulting in 'planned obsolescence'. Combining biology and computer technology as sculptural artworks gives me a perfect way in which to express my concerns about the problems of ever-increasing mountains of e-waste, and its effects on the natural world, especially at ground level where the waste is dumped.

The materials I use are obsolete computer gadget components. I find these objects to be perfect, precise, and beautiful, with all their intricate design and shimmering colours yet they are never meant to be seen by human eyes, hidden inside metal casings until they become obsolete, to be replaced by the newest technology. I like to create my pieces so that the components can be recognised, but as these objects are transformed into artworks, they become purely aesthetic with a total loss of their former functionality.

I am inspired by artists Leonardo Ulian and Franco Recchia. Ulian solders colourful electronic components to create ethereal looking mandalas, giving a sense of spirituality to electronics, almost as though to suggest a modern-day worship of computer technology. Recchia creates stunning cities from circuit boards and the inner components, and metal casings found inside old computers.

Both of these artists use the materials that I use and for many of the same reasons, but with entirely different results. It is exciting to see the creativity of other artists who see and admire what I see in these unusual art materials. □





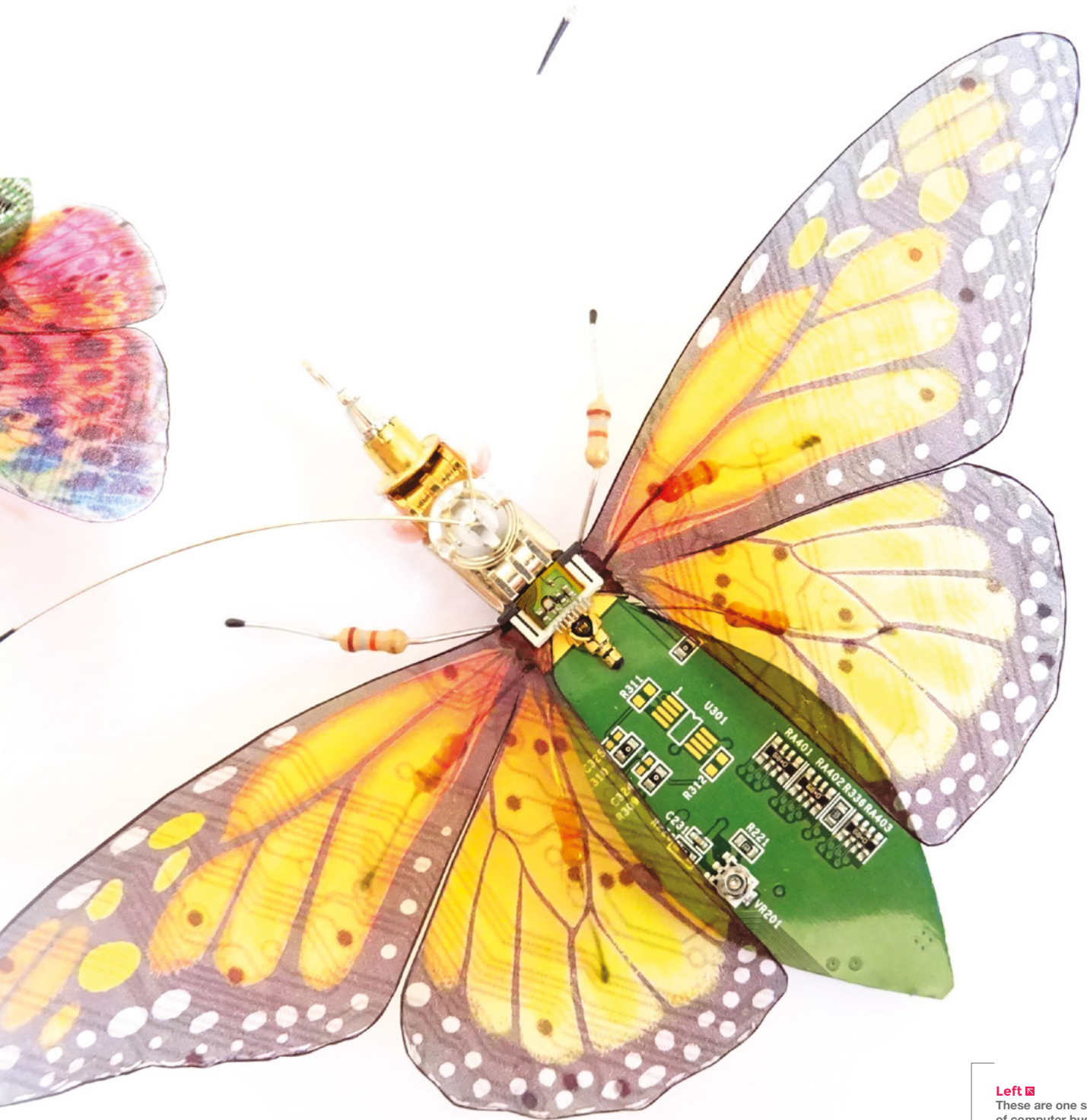

**Left**  These are one set of computer bugs that we enjoy







# Paper lanterns

By Vasili Lights

[hsmag.cc/1evYAZ](http://hsmag.cc/1evYAZ)

**V**asili Lights is an art and design brand by architect couple, Lidiya Koloyarskaya and Vasili Popov. We co-founded our Amsterdam-based design studio parallel to the architectural practice, because now and then, we want to take a break from the built environment, and turn our attention to designing smaller items.

Making things by hand gives you a feeling. The one that makes you calm, concentrate, and feel proud that you are making something.

We want to share this feeling with creative people by supplying our designs in the form of pre-cut paper templates, and step-by-step illustrated instructions.

In this way, we enable them to make things – to turn a flat sheet of paper into a beautiful 3D light, capable of bringing an ambient mood at home. □



Right ♦  
Paper craft can  
be as simple or  
as complicated  
as you like



# Rotary Phone

By Justine Haupt

 skysedge.us

**S**martphones are objectively horrible devices. They constantly demand attention, intruding into our thoughts and emotions with their endless beeps and bleeps. Unfortunately, once you have Google Authenticator on there for your work email and WhatsApp to keep in touch with family, you're hooked.

However much you hate it, you're always carrying it around. Unless you're engineer Justine Haupt that is. Justine, like us, hates the smartphone, but she's actually done something about it, creating this pocket-sized rotary phone from scratch to create a distraction-free, fully functional device.

"Why a rotary cellphone?", says Justine. "Because in a finicky, annoying, touchscreen world of hyperconnected people using phones they have no control over or understanding of, I wanted something that would be entirely mine, personal, and absolutely tactile, while also giving me an excuse for not texting."

"If I want to call my husband, I can do so by pressing a single dedicated physical key which is dedicated to him. No menus. The point isn't to use the rotary dial every single time I want to make a call, which would get tiresome for daily use. The people I call most often are stored, and if I have to dial a new number or do something like set the volume, then I can use the fun and satisfying-to-use rotary dial." □

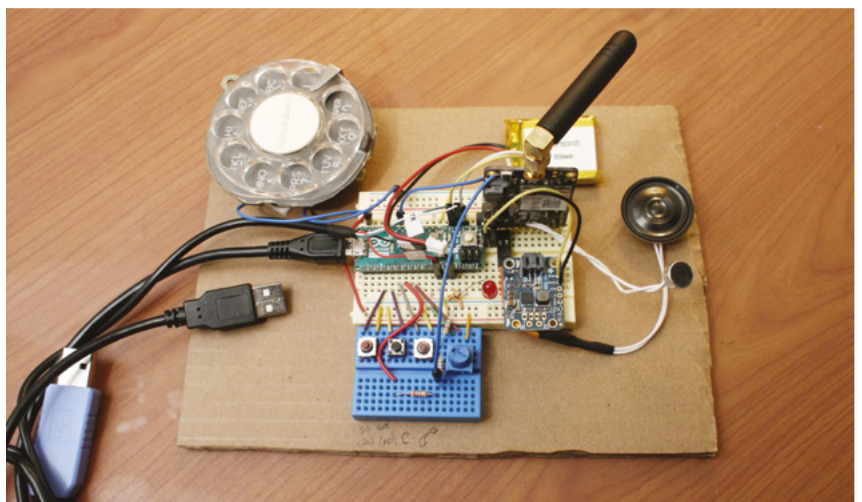

**Right** □  
A low-power consumption e-paper display (on the back of the phone) shows relevant information, such as the most recent missed call







# Objet 3d'art

3D-printed artwork to bring more beauty into your life

**S**ince Sir Les Paul attached strings to a lump of 4x4 pine, innovators have been finding new ways to make electric guitars. We've seen carbon

fibre, recycled plastic, graphite, softwoods like cedar and pine, and hardwoods such as maple and mahogany. Despite that, we've never seen a 3D-printed bass guitar, until now.

This object is the creation of Kenny Verhoeven-Rappa, a maker and designer from the Netherlands (you'll find more of his stuff here: [hsmag.cc/wLONKU](http://hsmag.cc/wLONKU)). An earlier version was entirely 3D-printed, but couldn't withstand the tension of the strings when tightened; Kenny's got around this problem by using a Yamaha neck. You'll be pleased to know that it works – Kenny plays all sorts on it, "from pop covers to heavy metal, and from small orchestra arrangements in a band, to improv pieces that just brighten the mood." □













# Paper plane

We've all made one... just not like this

**E**veryone who has ever been bored has, at some point, made a paper aeroplane. Bizarrely, as powered flight was only invented a few generations ago, it seems to be in our DNA. But one intrepid maker has taken the instinctive art of paper folding and elevated it to a level far beyond what we, as bored school kids, would ever have dreamed possible. His name is Luca Ionica-Stewart, and he's a UX designer.

Luca started this project in 2008 as part of a school assignment. Since then he's been adding, removing, rebuilding, and refining the build until it reached the state you see here – and he's still not finished. Notably, there are no wings, traditionally an essential part of an aeroplane. These are still in production. Luca estimates there's a couple of years' work until he's happy with them, but as they contain thousands of parts and have many, many articulating parts, it's a long process to get them right.

The toolkit is as minimal as it gets: two thicknesses of Manila paper, glue, a cutting board, metal ruler, and a sharp knife are all Luca's allowed himself. Even a laser cutter is off-limits, as the cut paper edges need to be cleaner than a burning laser can provide.

He works from photos and videos culled from the internet, or, where possible, technical drawings. Then the hard part begins: figuring out a way to turn a 3D part into a 2D slice that can be cut out, glued, rolled up, and assembled. With cheap tools, cheap materials, an endlessly patient nature, and impressive technical skills, anyone can make their own 1:60 scale aeroplane. What's stopping you? →

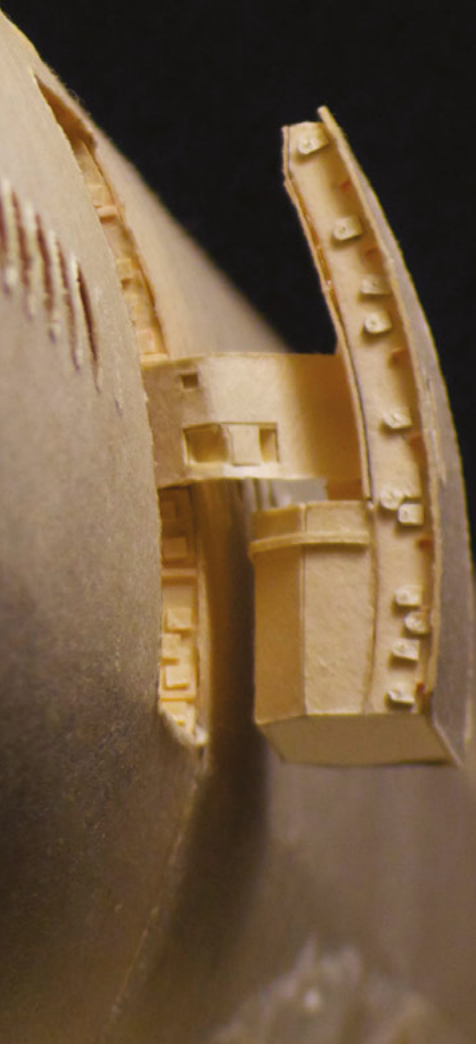



# Paper plane

## FEATURE

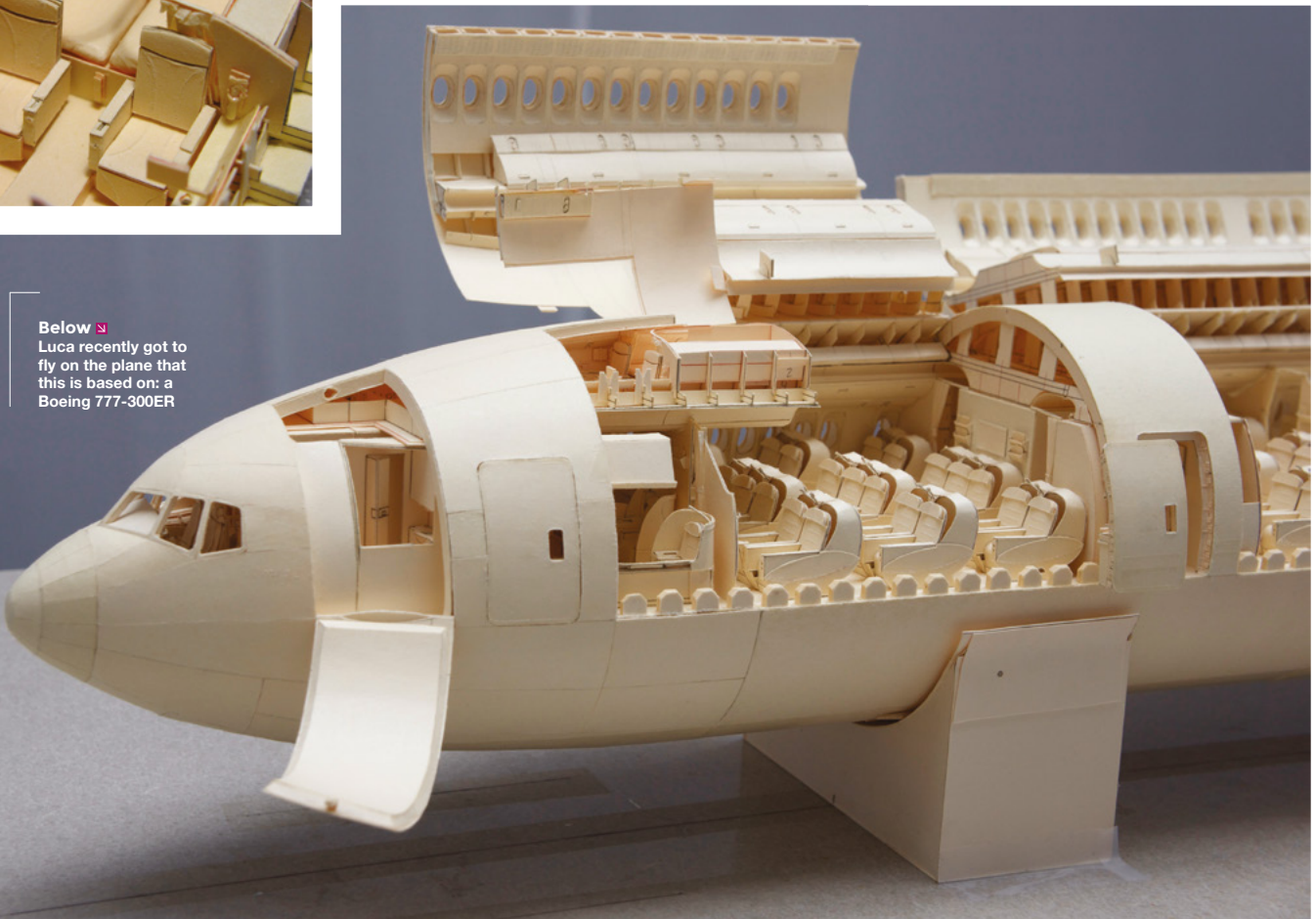
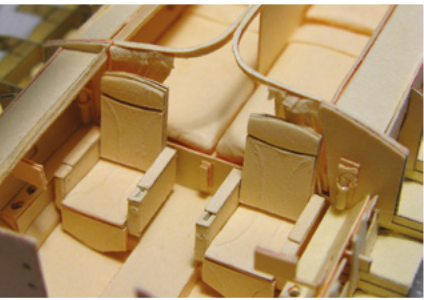
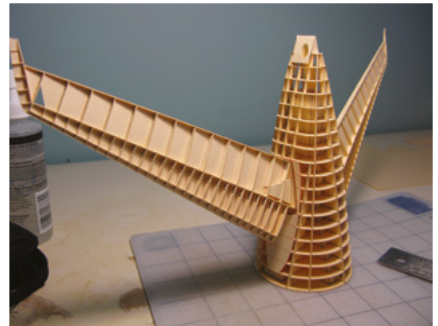

Below  Luca recently got to fly on the plane that this is based on: a Boeing 777-300ER





**Below**  Catch up with Luca's progress here [hsmag.cc/yhkPbe](https://hsmag.cc/yhkPbe)

**Left**  The landing gear retracts, complete with paper tyres, paper steering, and paper dampers as part of the paper suspension

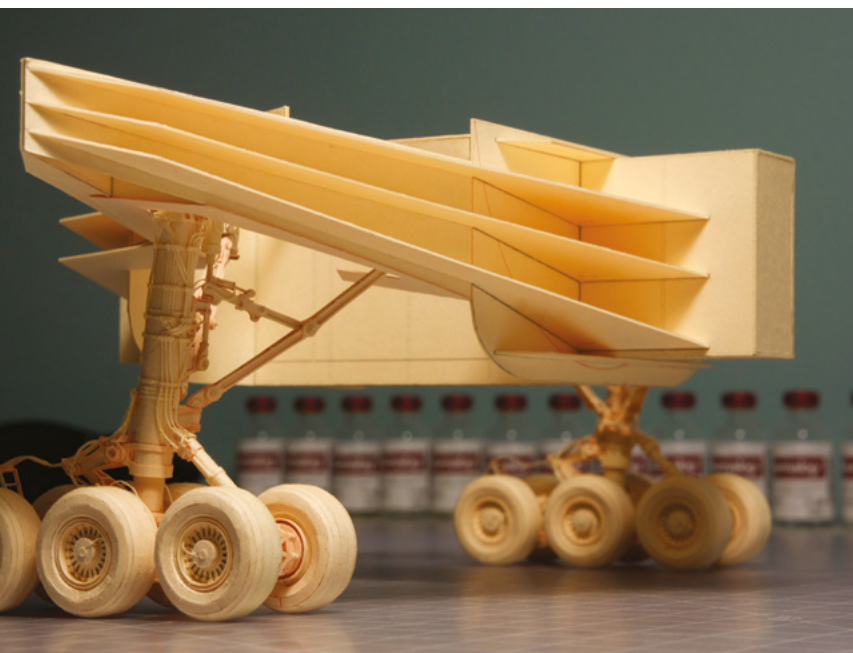



# Mobile multitool

Every tool's (not) a hammer



Lucy Rogers

[@DrLucyRogers](#)

Lucy is a maker, an engineer, and a problem-solver. She is adept at bringing ideas to life. She is one of the cheerleaders for the maker industry, and is Maker-in-Chief for the Guild of Makers: [guildofmakers.org](http://guildofmakers.org)

**W**e have probably all seen the photo of what a smartphone replaces, compared to 1980s technology – stills camera, video camera, audio recorder, calendar, diary, phone, TV, radio, etc.

But I had never really thought about it replacing items in my tool-box. Until I saw people tweeting about a multimeter that you could plug into a smartphone – and then the better idea (especially if you're measuring high voltages etc.): a Bluetooth multimeter. We all carry our phones around with us, so why not let it be the brain of our tools?

When I first got an iPhone, I was mesmerised by the spirit-level, ruler, and compass apps – although back in those early days I did struggle with actually getting the compass to point in the correct direction. However, I have never used them instead of 'analogue' tools. It never crossed my mind until after I'd got a spirit-level out that I could have used the phone.

But now my interest has been piqued, I've started investigating phone tools (it's quite difficult to search online for – the results include a lot of tool-kits for dismantling a phone).

Probably one of the most useful is the 'lone worker' or 'man down' safety monitoring application that allows employees (and I assume friends/family) to quickly request aid when working on their own, and no one else is around to call for help. Some of these include a

panic button or a hands-free trigger, such as a tether that just needs to be pulled from the headphone jack, so a request for help can be sent without having to unlock the phone.

Something else I'd not come across, and not something I need but I can see their advantage when having a lot of tools on-site, is Bluetooth-enabled power tools. The Bluetooth is used for monitoring where each tool is on-site and how much battery life is left. Some even support wireless charging.

You can also get items that either plug into your phone, or that wirelessly connect:

- Thermal imaging/infrared sensors
- Moisture and humidity meters
- Inspection scopes
- Stud finders
- Clamp and infrared thermometers
- Thermal and vane anemometers
- Laser distance measurers
- Differential pressure meters

You can also use your phone to measure – up to certain limits – audio power or noise levels, vibration, and magnetic flux. Then there are augmented reality apps that calculate slope, distance, and height. And of course, there's always the torch!

Combined with all these, you can get phones and cases that are waterproof and even MIL-spec rugged – so they can withstand drops, and extremes in temperature and barometric pressure.

Still, I doubt it will ever replace my hammer. □



# From the PDP-7 to your pocket

How UNIX took over the world



Drew Fustini

 @pdp7

Drew Fustini is a hardware designer and embedded Linux developer. He is the Vice President of the Open Source Hardware Association, and a board member of the BeagleBoard.org Foundation. Drew designs circuit boards for OSH Park, a PCB manufacturing service, and maintains the Adafruit BeagleBone Python library.

**L**ast time I was in Seattle, I took a trip to the amazing Living Computers Museum to see a restored PDP-7, the iconic minicomputer from the mid-sixties that my

Twitter handle pays homage to. Only five are known to have survived over the years, of which two are functional. The one I went to visit at the Living Computers Museum has been restored to do something extremely special: run UNIX Version 0.

Fifty years after Version 0, UNIX is everywhere. It is the root of the family tree that gave us macOS, Linux, and the operating system for every single iPhone and Android device. The impact UNIX has had on modern computing is impossible to overstate, and it all started with one borrowed PDP-7 at Bell Labs.

Bell Labs was the research division of AT&T, the only phone company in the USA at the time. AT&T's monopoly meant that Bell Labs had plenty of money for research, leading to inventions including the transistor, the laser, and the photovoltaic cell. It was in this culture of innovation that a small team of computer scientists, including Ken Thompson and Dennis Ritchie, were attempting to solve the big computing problem of the day: time-sharing.

In those days, if you wanted a computer to solve a problem, you had

to write instructions in assembly code, put it onto punch cards, then hand those cards to the computer operator to input when the next batch processing slot was available. Depending on how busy the machine was, this could take hours, days, or even weeks. Bell Labs was part of an ambitious project named Multics that aimed to create a time-sharing operating system that could handle multiple users at once.

Bell Labs eventually deemed Multics a failure, which left Thompson and the rest of the team without direction or, crucially, a computer. Undeterred, they found an unused PDP-7 in another department, who were persuaded to loan it out. In 1969, Thompson's family

went on a three-week vacation while he wrote an assembler, a file editor, and a kernel for the borrowed PDP-7. By the time his family returned, Thompson had created a multi-user time-sharing operating system: UNIX Version 0.

There is so much more to this story: the creation of the C programming language, the beginning of the free software movement, and the adventures of Thompson's pet crocodile. I'd recommend the Command Line Heroes podcast ([hsmag.cc/PfhNL0](https://hsmag.cc/PfhNL0)), or you can make the trip over to the Living Computers Museum and see it for yourself! 

**Only five are known to have survived over the years, of which two are functional**



# Letters

## ATTENTION ALL MAKERS!

If you have something you'd like to get off your chest (or even throw a word of praise in our direction) let us know at [hsmag.cc/hello](http://hsmag.cc/hello)

### A BIT SLIPPERY

As always, I am loving my current issue of HackSpace magazine. But I ran across a minor issue that might confuse readers. It could, at least, use a little deeper explanation from the author.

On page 23 in 'Python on hardware', Drew Fustini says that Python is an interpreted language and is not compiled. But Python IS compiled. It compiles just before it runs. It compiles into binary bytecodes that execute in a simulated processor (very much like Java). This is true even for MicroPython.

The author probably meant that Python doesn't compile into 'native' binary that runs directly on the processor.

Why is the distinction important? This binary compiled bytecode is much, much faster than a pure interpreter would be. And the binary compiled-code is kept on the device for the next execution (the compiler only runs once).

Thanks again for your magazine!

**Christopher**

**Ben says:** Is Python compiled or interpreted? In truth, it doesn't really fit into either category very well. From the user's perspective, it runs exactly as you would expect an interpreted language to work. You change the code, then it's one step to run it. From the computer's perspective, it runs more like a compiled language – the computer doesn't care that the compiler and virtual machine are controlled by the same command or action. We call Python interpreted because that's how it appears to the user, but if you progress with the language, it's useful to remember that this is really a little white lie.



Below ↗ Python seems to be everywhere these days





**Left**  What can you make that goes beyond the everyday?

**Below**  The data doesn't lie. Perimeters have a better strength to weight ratio than infill

## BARREL OF LAUGHS

I loved seeing Josh Kroger's whisky barrel PC in issue 28. I'm a firm believer in the fact that we should surround ourselves with beautiful objects. Too long have beige boxes dominated the office. Yes, it might take a bit longer and be a bit more expensive to make something this eye-catching, but it'll be in your eyeline for years (decades maybe if you continue to upgrade it), so why not spend a little time and money turning it into an object of art?!

**Keith**

Norwich

**Ben says:** We couldn't agree more. In a world of the ordinary, we stand shoulder to shoulder with people who believe in the extraordinary. Everyone should have things that make them smile, and a fantastic way of doing this is rolling up your sleeves and making it yourself. Josh's PC is a great example of this, and we encourage everyone to have a think about the objects they surround themselves with and think about whether they are as beautiful as they could be. If not, well, you know what to do.

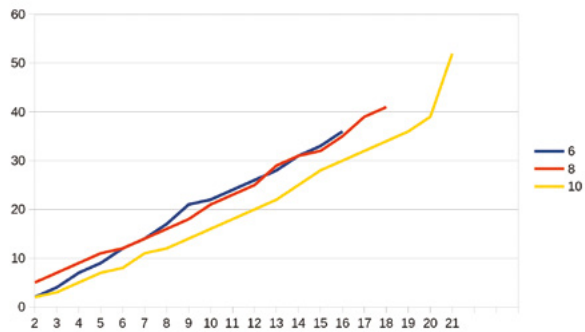

## STRENGTH IN NUMBERS

I've been dutifully adding infill when I needed stronger 3D-printed parts – turns out I might have been wasting filament. It was good to see you experimenting with different options for making stronger prints – I'll start adding more perimeters now!

**Paul**

New York

**Ben says:** Infill is but one tool in the 3D printer's armoury. It helps, but there are plenty more things we can do to strengthen our prints. Stay tuned for the next few issues, as we'll be experimenting with more options to see if we can find even better ways of making our prints strong.





# CROWDFUNDING NOW

## Orange Crab

Feather meets FPGA

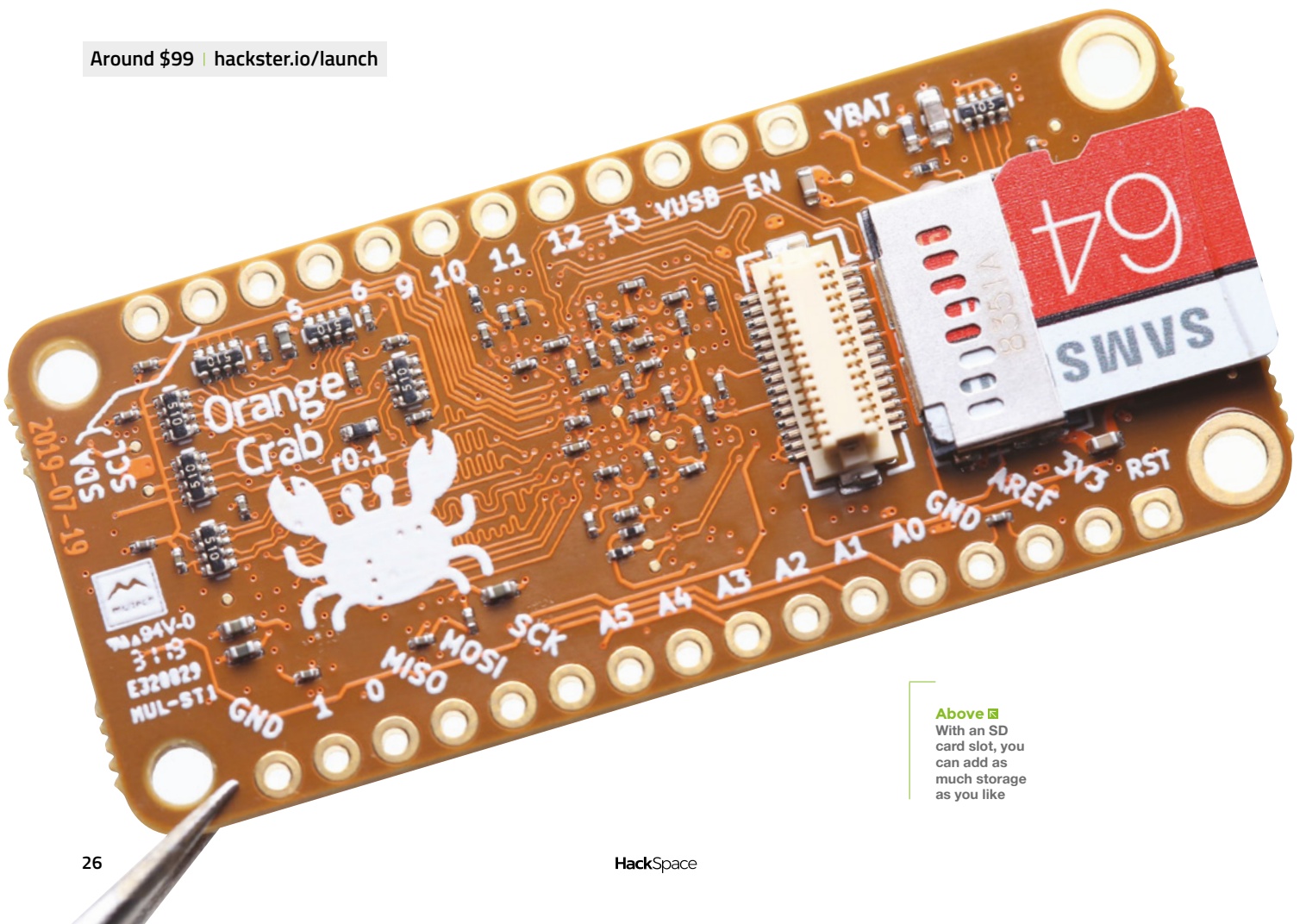
Around \$99 | [hackster.io/launch](https://hackster.io/launch)



Above  With an SD card slot, you can add as much storage as you like

## BUYER BEWARE

When backing a crowdfunding campaign, you are not purchasing a finished product, but supporting a project working on something new. There is a very real chance that the product will never ship and you'll lose your money. It's a great way to support projects you like and get some cheap hardware in the process, but if you use it purely as a chance to snag cheap stuff, you may find that you get burned.

**F**ield Programmable Gate Arrays have been around for a while, but it's only in the last couple of years that they've become accessible to makers.

The technology is a bit complex to get your head around if you're used to regular programmable electronics, like microcontrollers or computers. But in essence, they're a bit like those old electronics sets where you got a lot of electrical components on a board and could arrange the wires to make different projects. You could think of the locations of the wires a bit like a program that you upload by placing wires. FPGAs do a similar thing, but on a much, much larger scale. They contain logic units that you can upload a program to that dictates how they're all connected.

This flexible nature means that you can do a lot of different things with them, such as trying out different CPU cores (e.g. the open-source RISC-V). FPGAs are also well-suited to processing large amounts of data, because everything doesn't have to go via one single CPU. You can connect the logic units in such a way

that they manipulate the data in the right way, rather than building a processing core that runs a program.

That's FPGAs but what makes the Orange Crab, in particular, special? Well, it's in the Feather form factor which means there's loads of add-on hardware already available; it comes with a whopping 128Mb of DDR 3 memory, 128Mb QSPI flash, and variants supporting the Lattice ECP5 25, 45, and 85. To help you get started, there's a repository of example code at [hsmag.cc/mvQWwW](https://hsmag.cc/mvQWwW).

For fans of all things open, the Orange Crab is open-source hardware, and is programmable with an open-source toolchain.

At the time of going to press, the final price was yet to be decided, but looked likely to be around \$99. If you're looking to get into FPGA development, this could be an excellent choice. 

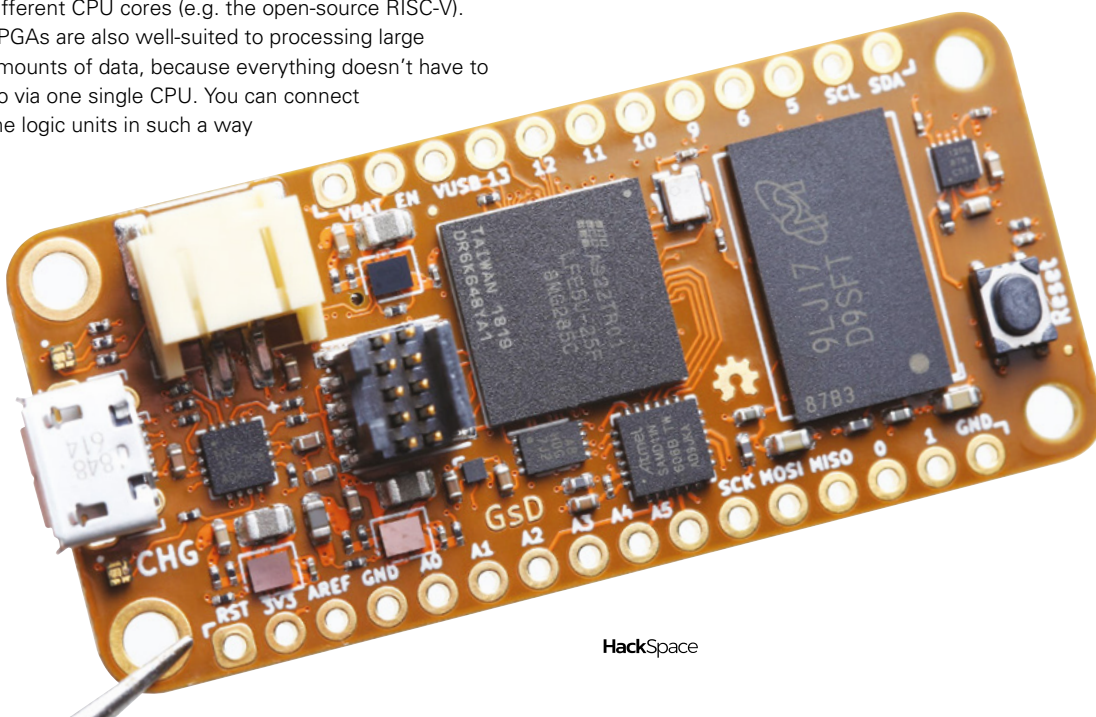

**Left**  The Feather form factor is compact, but still leaves enough room to squash in quite a lot of features



# Space of the month: Dundee Makerspace



## Dundee Makerspace

[dundeemakerspace.com](http://dundeemakerspace.com)

[f](#) dundeemakerspace

[t](#) dundeemakespace

[i](#) makerspacedundee

**D**undee Makerspace started in 2014, and was founded by software engineers who wanted a place to play with electronics and practice coding together – things have changed since then!

We have around 30 members at the moment. We're actively recruiting members as this is currently the main way we pay the bills, but we are also now branching out into teaching classes and making products.

We have everything from a laser cutter and 3D printers, to an electronics workbench and even a reasonably well-stocked woodworking shop. We also have a lot of craft items, and lately, we've focused on growing our textiles offering, with an area dedicated to sewing machines, an embroidery machine, and a new director, Jen, who is a professional knitwear designer. My background is in philosophy and psychology, but I have an interest in many subjects, and I previously managed a ceilidh band, before moving on to my current self-employment as a CAD



We want to foster growth of the creative arts and sciences in Dundee



modeller. And our other director, Kerry, is the editor of Micro:Mag, a magazine covering the micro:bit microprocessor and related accessories. She also teaches Raspberry Pi workshops.

Our motto is 'Make, Learn, Create'. We want to foster growth of the creative arts and sciences in Dundee. The makerspace is about more than just having a place to work; it is also a social hub and a place of learning and skill-sharing. Although we run some educational classes (an area we are going to grow a lot over the next year) we also maintain a →

**Right** Finally, we want to be a job creator, so when we are in a position to take on employees, we certainly intend to do so, at the real Living Wage











focus on peer learning and informal teaching between members. Anyone who has something they want to achieve, but lacks the skills to achieve it, can ask to be put in contact with a member who has experience in that field.

One of the nice things about the space is that we get a complete mix of users, from university students and lecturers from the two universities within five minutes walk of the space, to seasoned industry professionals in computer gaming and engineering. Our oldest members are well into their retirement years and, during our planned classes, we welcome



and still working (for demonstration purposes). So it is perhaps fitting that we are continuing a strong textile heritage in this building.

We find most of the people who come to do textiles here are younger, teens, uni students and so on, but we do have a few older people.

We probably lure in more older members with our woodworking room than anything else. Though Dundee is also home to Scotland's largest Men's Shed, so many of the older men who might otherwise come to us are better served by that facility instead (they have a ridiculous amount of lathes and other woodworking tools!) We are trying to work out better collaboration opportunities with them so they can come and help teach lathe-work at our space (we have one lathe bought from them).

In the last couple of months, we've run the textiles courses, a build your own pollution sensor workshop (linked into the Luftdaten initiative and lead by Dr David Martin from Dundee University, who is one of our most enthusiastic members) and a Build a Planter workshop in our woodworking room, lead by a local woodworking schoolteacher. We got a lot of the community in for that one, as it was targeted and partially funded by a local community centre. □

### Above ♦

Dundee is also the original home of DMA Design (now Rockstar North) who designed the Lemmings series whilst they were here (Dundee Makerspace has a number of 3D-printed lemmings as a result)

### Right ▣

Dundee Makerspace was until recently in the Blackness Industrial Estate, surrounded by old jute mills

**// We hope that...we can work with more local businesses, charities, and the council to provide opportunities //**

secondary school students into the space. You really don't get access on such an even playing field to a mix of people quite like this anywhere else but a makerspace!

We also want to better integrate into the community, and we hope that in the future we can work with more local businesses, charities, and the council to provide opportunities to all willing citizens of Dundee and the surrounding areas.

Dundee was a textiles town 150 years ago, and so most of our industrial buildings are former jute mills, with a particular concentration in our area. The Dundee Verdant Works museum is right around the corner from us, and shows what it was like working in a jute mill, and some of the old machines are there



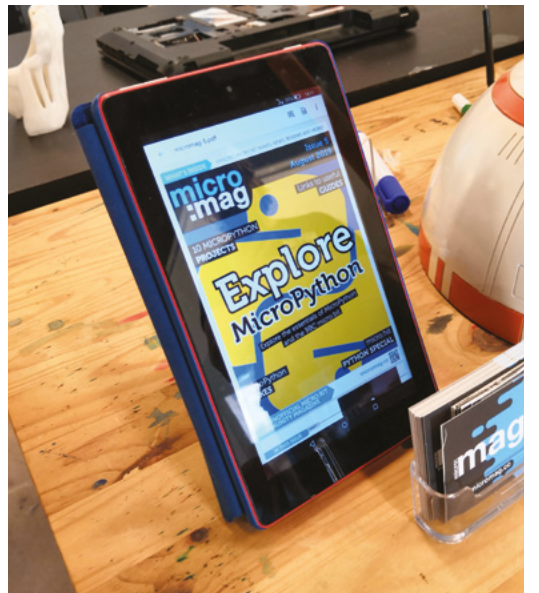

### CONTACT US

We'd love you to get in touch to showcase your makerspace and the things you're making. Drop us a line on Twitter @HackSpaceMag, or email us at [hackspace@raspberrypi.org](mailto:hackspace@raspberrypi.org) with an outline of what makes your hackerspace special, and we'll take it from there.

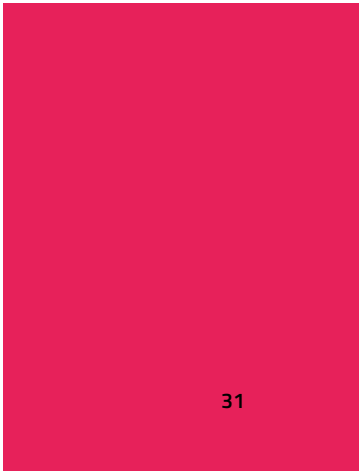





# Build a Makerspace for Young People

Join our **free online training course on makerspace design** to get expert advice for setting up a makerspace in your school or community.

**Sign up today: [rpf.io/makerspace](https://rpf.io/makerspace)**



# LENS

HACK | MAKE | BUILD | CREATE

Uncover the technology that's powering the future

PG  
52

## HOW I MADE: BINDAYCATOR

Never forget to take out  
the bins again

PG  
58

## IN THE WORKSHOP: LITHOPHANES AND GAMES

What we've been making in the  
HackSpace magazine workshop

PG  
62

## INTERVIEW: CHARLIE BETHEL

Using sheds to tackle mental  
health and loneliness



PG  
34



Create beautiful objects with  
this natural material

PG  
70

## PLAYING CARDS

A surprisingly versatile construction tool

PG  
74

## TESTING NEOPIXELS

Pushing these LEDs to their limits



Get started in

WOOD

WORKING

From furniture to  
architecture, small to large  
objects, cutting boards to  
sculpture, woodworking  
surrounds us

By Norman Pirollo



**W****ood is easily worked.**

It can be squared off and joined into furniture, or used to carve out an object.

Woodworking dates to the Roman Empire, with several hand tools used today having origins in this early time period. Woodworking can be done in a small space with a few simple hand tools, or in a small workshop if machines are part of your woodworking.

Technical schools introduce woodworking through hand tools as it provides the student a close bond to wood. Hand tools are an enabler to woodworking. Machines were developed to speed processes and quickly churn out furniture and wood objects – so if you're just working on a few pieces for yourself, you really don't need much. A few hand tools will get you going and provide the immediate satisfaction of creating a tangible object. →





**Right**  
Sharpening a chisel  
on a water stone  
using a sharpening jig

**With learning in mind,  
it's best to practice on  
lower-cost woods**

Joinery brings wood parts together. When creating furniture pieces, precision is critical for strong joinery. With learning in mind, it's best to practice on lower-cost woods (this will vary depending on where you are – maple is a lot cheaper in North America than it is in Europe, for example). After you are confident, switch to more expensive woods.

#### **FROM START TO FINISH**

All woodworking tools, hand or machine, have cutters. Cutters will get dull, so it's wise to spend a bit of time learning the art of sharpening.

Understanding wood is another essential skill. Wood is composed of grain, which is directional in nature. Keep this in mind and you will soon learn that cutting with the grain is preferable to cutting against the grain!

Woodworking develops your hand-to-eye coordination where the eyes lead the hands. After some time woodworking, certain movements become second nature, and muscle memory takes over. Until then, practice and repeat movements with tools until you are at ease with sequences.



**Left**  
Fine paring work can be achieved simply using a chisel and a woodworking vice

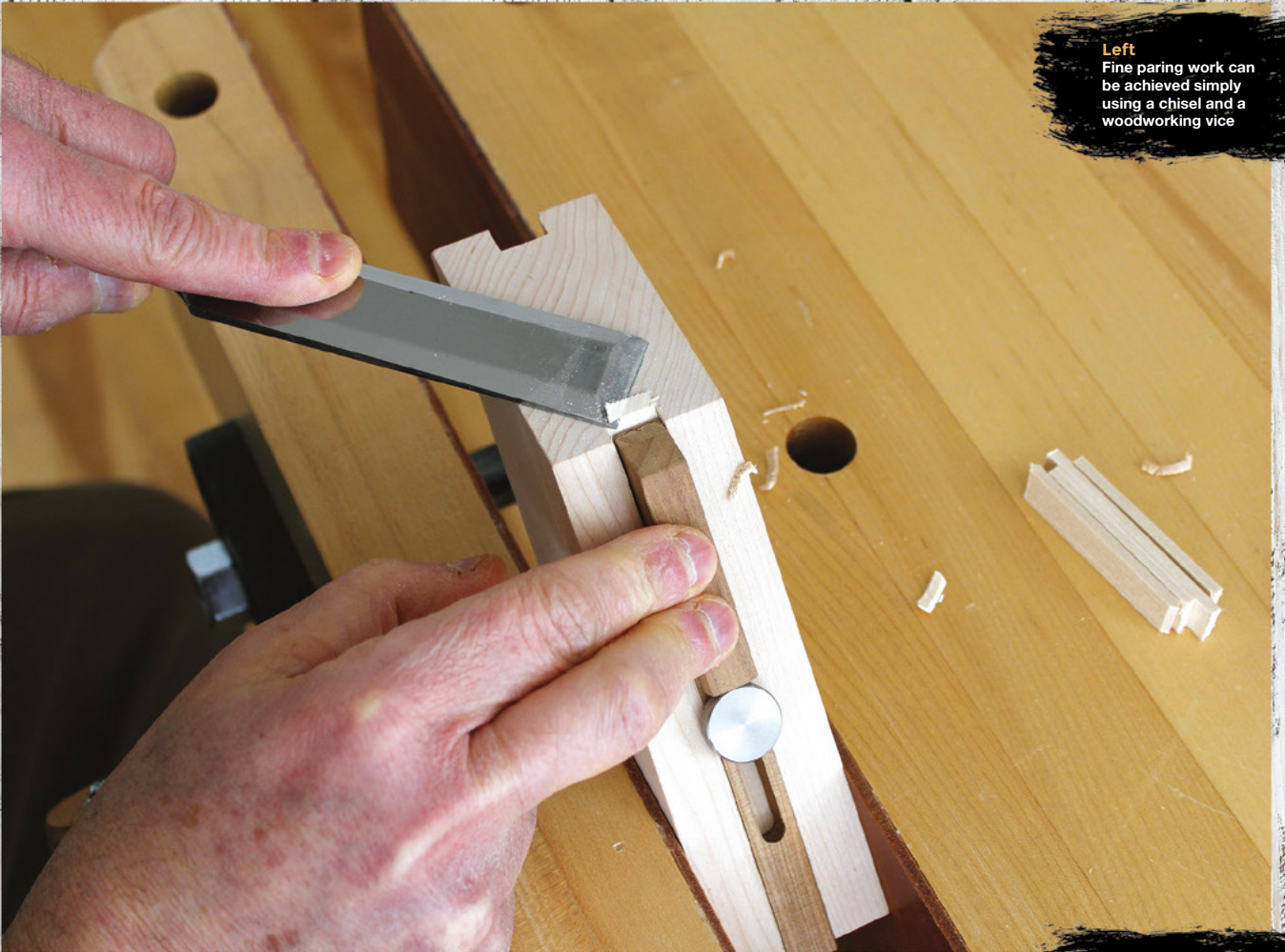

**Below**  
A collection of the different types of wood finishes

We've already said that you don't need machines, and there are plenty of benefits to working with hand tools: they're quiet, for one, so they're ideal if you're working where people live. Then there's versatility: you just need a solid workbench, and a few hand tools to get started. A vice on the workbench holds wood while you perform cuts.

Finishing is an important skill to grasp as it seals and protects the wood, as well as making it look even better than it does naturally. Finishes range from organic to chemical. Chemical finishes are hard and resist moisture and wear. Natural, organic finishes are increasingly common and ideal if the project is not too exposed to wear. Oils soak into wood and leave a natural texture. Other finishes sit on the surface obscuring the wood grain – the choice is yours. →





# BASIC TOOLS

The bare essentials for your workshop

## Drills

There are few woodworking projects that don't involve a drill. Drills are portable, and either cordless or plugged in. Alternatively, get a manual or hand drill and skip the need for power. Drills create pilot holes for screws, through-holes for dowels, and holes for chair parts. Once your woodworking progresses, a drill-press can bring your work to the next level of precision.



**Left**  
A group of hand tools, including hand plane, chisels, back saw, block plane, mallet, ruler



**Above**  
A commonly available cordless drill, suited to most woodworking applications



## Workbench

Unless doing light wood-carving, you will need a workbench to work on. It should handle pounding with a hammer and be rigid enough for hand planing tasks. You can purchase a workbench or make your own. Your first workbench need not be fancy; it only needs to be sufficient to begin woodworking. As well as providing a sturdy surface, a workbench also needs a way of clamping a workpiece in position, most commonly a vice. Vices are relatively inexpensive and, in their simplest form, mounted to a workbench surface.

The vice will be your most used tool. It prevents wood from moving when shaping or creating joinery. Woodworking vices are rugged, withstand heavy use, and are available in several sizes. Purchase a larger one than you currently need to avoid outgrowing its capacity – this lowers the cost of replacing it with a larger version early on in your woodworking.

**Below**  
Woodworking vice attached to front of a workbench

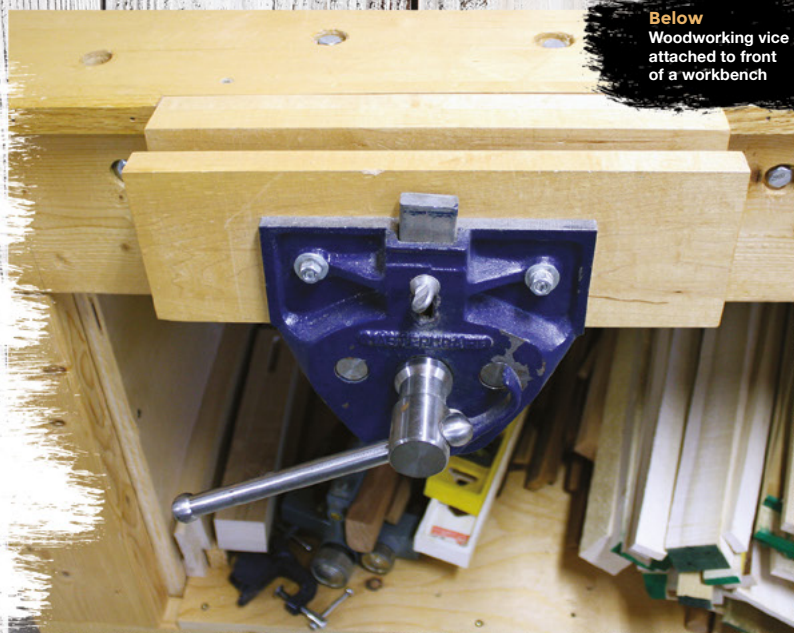

## Chisels

Chisels shape, remove wood, and create recesses. Fine work is achieved with chisels: they create mortises for tenons or make a recess for installing a hinge. They slice wood in a paring action or remove wood when struck with a mallet. Chisels are available individually or as a set of commonly used sizes.



**Above**  
A set of fine paring chisels

## Clamps

Clamps are a large component of woodworking. They brace wood together for gluing, hold wood while using hand tools, and are used to assemble furniture pieces. Clamps come in various lengths and capacities depending on the application. Some clamps operate with one hand; others need two hands to tighten. Invest in clamps of different capacities early in your woodworking. >

**Below**  
You can never have enough clamps

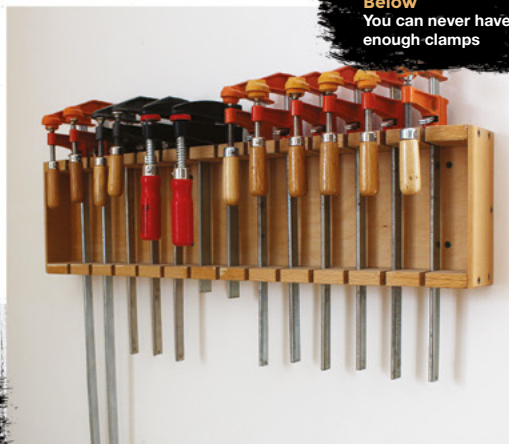

## The jig's a good'un

Become familiar with the term woodworking jigs. Jigs ensure that multiple, similar parts have the same dimensions. Jigs speed setup time, and enable you to easily recreate a woodworking project in the future.





## FEATURE

### Hammers

Hammers are available in several formats. Light hammers drive small nails into wood, or are used for delicate assembly. Large, heavy hammers pound mortise chisels to create square openings. A mallet is a hammer unique to woodworking, and is often found on workbenches. A wood mallet is a good choice when outfitting a first set of woodworking tools as they excel at fine, delicate paring when used with chisels.



Right  
Common  
woodworking  
hammers and  
wooden mallets

### Levels

Another valuable tool in the workshop is the level. It tests if your work is perfectly horizontal or vertical and is essential in furniture making. Levels are made of wood, metal, or plastic, and range from two feet to six feet in length. A bubble in a glass vial indicates whether plumb is achieved. A good level should be one of your first woodworking tool purchases.



Above  
Small torpedo level used to level a board. The bubble in the centre vial indicates that the board is level

### Marking gauge

A traditional method to lay out lines to guide chisels and saws uses a marking gauge, which speeds up identical, repeat operations. A simple tool, it consists of a fence that slides on a beam and tightens with a thumbscrew. The etched mark or line is defined by a sharp pin, or in modern versions, a circular disk with sharp edge.



Above  
Marking gauge used to create an etched line across the end of a board

### Saws

You should own two types of saws; a rip saw and crosscut saw. Ripsaws cut along the grain or parallel to it, and crosscut saws cut perpendicular to the grain. In other words, a rip saw makes a board narrower, and a crosscut saw shortens a board. The teeth arrangement and number of teeth per inch (TPI) define the function of a handsaw. Coarse teeth (low TPI) are used to rip wood, while fine teeth (high TPI) are better at cross-cutting and fine work.



Above  
Above, fine-tooth back saws for sawing dovetails



## Rulers

A ruler is a must in a workshop. Rulers measure board dimensions, mark where cuts are made, and ensure furniture parts are similar in dimensions. The expression 'measure twice and cut once' applies. A spring-wound tape rule is the tool for measuring and marking long lengths of wood.



**Right**  
Metal ruler  
laying out marks  
on a board

## Square

In furniture making, saw cuts and joints need to be at right angles to each other (square). The metal square performs this function when laying out work, making saw cuts or preparing parts at a 90-degree angle to each other. If all parts of your project are made square, the final piece is certain to come out square with sides at 90 degrees to each other. Ideally, two metal squares are necessary in your woodworking.

- Combination square for small work
- 8 x 12 inches (200 x 300 mm) carpenter's square for wide boards and furniture-making

The combination square determines if your work is square or not. A combination square has a sliding head with 90-degree and 45-degree angled sides for mitres. The head is removable, leaving the blade free to use as a ruler or straight edge.

## Hand planes

Hand planes address multiple woodworking tasks. Wood must be smoothed, squared, and fitted, and different hand planes perform these tasks. Specialised joinery hand planes also create grooves and rabbets in wood.

Hand planes consist of a blade set at a defined angle in a metal or wood body. The blade protrudes beneath the sole to create a slicing action. A knob raises or lowers the blade to adjust the depth of cut. Hand planes cut on the forward motion (pushed) and are pulled back for the next stroke. They are used with one hand on the front knob, while the other grips the rear handle or tote. Several versions of hand planes tackle different tasks. You should begin with three planes: the jack plane, smoother, and low-angle block plane form a good basic set. As you progress, determine which hand planes you need next. →



**Right**  
A collection of common  
hand planes in different  
sizes and functionality



**Right**  
Combination square  
laying out the face of  
a board. The rule can  
be separated from the  
head. Note the available  
45-degree angle. The  
combination square is a  
versatile measuring and  
marking tool





## Selecting the right type of wood for every project

**T**

**he wood that you select for a woodworking project often determines the aesthetic.**

Lumber is either softwood or hardwood: softwood lumber is used in construction and woodworking. Softwoods such as pine, fir, and cedar are plentiful, and coniferous trees grow fast.

Hardwood, or deciduous trees, grow slowly. Common hardwoods are walnut, mahogany, maple, birch, cherry, and oak, and are preferred in furniture making due to their durability.

Trees have bundles of fibres and vessels running along the trunk. Wood grain is formed by this bundle. Oak, maple, and birch trees have straight grain. As a tree grows, new fibre and vessels are added to form rings that determine the age of a tree. Some trees grow faster than others.

The outer, live layer is the sapwood. The sapwood eventually turns into heartwood and a new sapwood layer is created. Behind the sapwood is the heartwood. No longer conducting sap, it provides strength and support for a tree.

Logs are cut in several ways. The simplest way to cut up a log is known as plain sawing. Plain-sawn





**Left**  
Cross-section of softwood board. Growth rings are distinct. Diagonal growth pattern is rift cut, between plain-sawn and quarter-sawn



**Left**  
Cross-section of plain-sawn log with boards sawn tangentially to growth rings. This is how most lumber is cut. Plain-sawing introduces the most movement and warping in boards

boards are made by slicing parallel cuts through the log. Plain-sawn boards can warp because of their grain orientation.

A more involved way of cutting a log is to slice it up quarter-sawn. Quarter-sawn cuts don't warp because they are cut perpendicular to the log.

The cross-sections of a log show circular growth rings, the lines indicate plain-sawn or quarter-sawn cuts. Plain-sawn boards are cut tangentially to growth rings. Quarter-sawn boards are perpendicular to rings. With quarter-sawing, horizontal expansion and contraction in boards is eliminated.

### WOOD DEFECTS

Defects in wood detract from its appearance and strength. Good grades of lumber have few defects. A knot in a board is the beginning of a branch. In the furniture industry, wood with knots is used in hidden furniture parts, unless a rustic aesthetic is desired.



**Above**  
A knot from a cut branch in a log

**A knot in a board  
is the beginning  
of a branch**

### SELECTING WOOD

Oak is open-grain and rough; maple is closed-grain and smooth. Maple, birch, and poplar are white; padauk is red; ebony is black. Some woods fade (such as walnut), and some darken over time (such as cherry). Consider this when choosing boards for a project.

Softwoods are used in construction and in the DIY market. Hardwoods are used in cabinetry and furniture. Hardwoods are more expensive than softwoods and sold as rough lumber. Purchase boards from a small supplier where they can be examined. Bring a tape-measure to check dimensions, and ask the supplier if they can cut your lumber to size.

### MOISTURE CONTENT

When a tree is cut, it's high in moisture. After processing, the wood dries. Wood eventually reaches equilibrium with its environment (or equilibrium moisture content, EMC). The EMC of wood in a heated room is 10 percent. Freshly cut logs can reach 100 percent EMC. When moisture evaporates to within →



## FEATURE



Left  
Joinery pieces  
show colours and  
tones of different  
wood species

## How lumber is measured

Hardwoods used in cabinetry and furniture are sold using a board foot measurement (UK, US). In the example below, T is the thickness (inches), W is the width (inches), and L is the length (feet). To calculate board feet of lumber:

$$T \times W \times L / 12$$

If board is 3 in. thick (T), 8 in. wide (W), and 5 feet long (L) this is:

$$3 \times 8 \times 5 / 12 = 10 \text{ board feet (UK, US)}$$

The formula calculates board feet of rough lumber. Lumber is initially in a rough state.

1 bd. ft. (imperial) = 1 in. × 12 in. × 12 in.

1 bd. ft. (metric) equivalent = 25 mm × 300 mm × 300 mm

30 percent EMC, moisture in wood cells evaporates, and cell walls shrink. The wood then shrinks.

Kiln drying relieves stresses in wood and lowers EMC. Dry wood is strong, light, stable, and ideal for furniture. Kiln-dried wood is available at wood suppliers.

### PROCESSING WOOD

To dimension lumber, a mitre saw, table saw, band-saw, planer, and jointer are necessary (that's why most people get this job done at the lumber yard). In my workshop, I dimension rough planks of wood into manageable lengths and sizes using machines. The dimensions are defined in furniture plans.

When processing boards from large planks, acclimate the wood for several days between steps. After reaching the EMC of your work area, the wood will be stable and will warp less. If lumber is not



## Movement

Wood moves even after it is sliced into boards and assembled into furniture or wood objects. Wood is not a dimensionally stable medium. It absorbs and releases moisture depending on the environment it is in, causing it to expand and contract. Wood moves along its width but not along its length. In furniture making, frame and panel construction was developed to house large panels in a wood frame. A small gap surrounds the panel to absorb expansion and contraction. Unless wood movement is factored into your woodworking projects, you run the risk of your workpiece coming apart.



### Right

A wood rack with wood planks. Wood is stickered where each plank is separate from the other. This allows air to circulate around a board equalising EMC of the wood. Stickering minimises cupping, twisting, and bowing of rough boards

acclimated, tension forms when a plank is sawn and exposed to air.

## PLYWOOD AND ENGINEERED WOOD

Plywood consists of layers of veneers, or plies, glued at right angles to the other. The outer ply is the face; inner plies form the core. Inner plies make a panel strong and dimensionally stable. Plywood sheets come in standard widths and lengths.

Particle board, waferboard, or chip-board are man-made woods. Wood particles, wafers, and fibres are glued using resins. Particle board consists of sawdust or planer shavings, with resin added to form a panel. It is then pressed at a high temperature and trimmed to the desired length and width.

It is in your best interests to buy good-quality wood for projects. I have seen projects fail from improperly dried wood. I have seen warped door panels and cabinet frames caused by stressed wood. Storing wood correctly with air circulation prevents warping. ➔



### Left

Furniture component boards sawn from one plank. The boards are cut to dimensions in the cabinet plan and are then prepared for joinery



### Below

A cabinet panel formed by gluing together boards, shown earlier



### Left

Baltic birch plywood (bottom two), MDF above, chip-board at top



# PROJECT

## Make a bench hook

Create this useful  
workbench accessory

**I**n my woodworking journey, I soon realised that accuracy and repeatability are critical to precise joinery and mitres that fit correctly. Trimming small parts to precise lengths is important. Often, a band-saw or table saw are used. Although precision is achieved using machines, the large capacity of a band-saw or table saw is better suited to large wood parts. With small parts, the saw-blade kerf can equal the amount to trim. In other words, large machines are not conducive to working with small furniture parts. Additionally, cutting small parts on a machine is not safe, as your hands are close to the blade.

A better solution is the bench hook. When used with a fine saw, it provides accuracy when trimming small parts. It has a fence for a small workpiece to be held against, which is also the guide for the handsaw blade, and the action of sawing the workpiece keeps it tightly against the fence.

You can easily make a bench hook from scrap wood. It consists of three components; the base,

fence, and hook. The fence is the business end; the hook attaches underneath, and keeps the bench hook against the edge of a workbench. The fence and hook are at opposite ends of a flat base, which can be a small piece of plywood. Plywood is dimensionally stable and lends itself well to a bench hook. The fence and hook are made of softwood or hardwood. Hardwood is preferred as it wears.



**Left**  
Bench hook with left shoulder. The fence is shorter than the base. Fine-tooth back saw





**Right**  
Bench hook with 90-degree straight and 45-degree mitre slot



**Left**  
Bench hook with adjustable stop for repeatability

### BENCH HOOK VARIATIONS

There are two versions of the classic bench hook. One has a fence shorter than the width of the base (open-ended). A shoulder is created at the end of the fence. A handsaw is used with the fence to make a square cut. Another version has a fine saw-blade housed in a narrow kerf in the fence. When sawing, this introduces more control and accuracy, since there is no way the blade can twist, so you can achieve precise 90-degree and 45-degree cuts.

A back saw is used with a bench hook as it has a rigid back. This keeps the blade from twisting, ensuring a straight cut. Back saws have either rip or cross-cut teeth. Since bench hooks cross-cut pieces to length, a cross-cut tooth pattern is ideal. Mitred slots added to your bench hook increase the versatility. Pre-cut mitre slots can be standard 30-, 45-, and 60-degree angles.

To create the mitre kerf in the fence, pencil marks guide a saw-blade into the fence. Small workpieces held against the fence are then cut at this angle.

**Repeated nicks make  
the slot wider,  
removing the precision**

The saw blade will eventually nick your bench hook fence. Repeated nicks make the slot wider, removing the precision. The slot can be filled in and recreated, or a new slot made. When no space remains, the fence can be replaced, or a new bench hook created. The fence eventually wears, and accuracy is compromised. Simply trim the fence end to create a new edge. The bench hook life is now extended!

Bench hook dimensions depend on the size of the components you trim. Small, portable bench hooks are quickly positioned. Larger bench hooks occupy more workbench space, which is something to consider. Bench hooks don't last forever, so it's wise to make your own. →

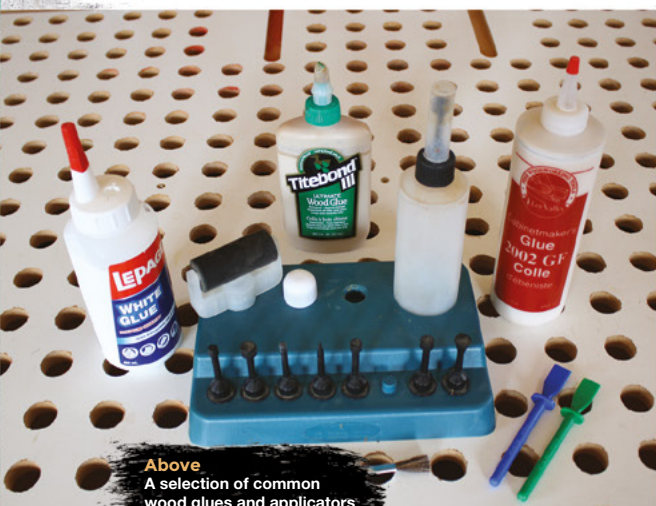

**Above**  
A selection of common wood glues and applicators





FEATURE



**Right**  
Saw a length of 2 x 2 in. (50 mm x 50 mm) at 1 in. (25 mm) shorter than width of base. This forms the fence. Apply and spread glue to the underside of the fence



**Right**  
Align (left or right) the fence to front edge of base. Use square to ensure fence is 90 degrees to side of base. Rub fence and base together, creating a rub joint

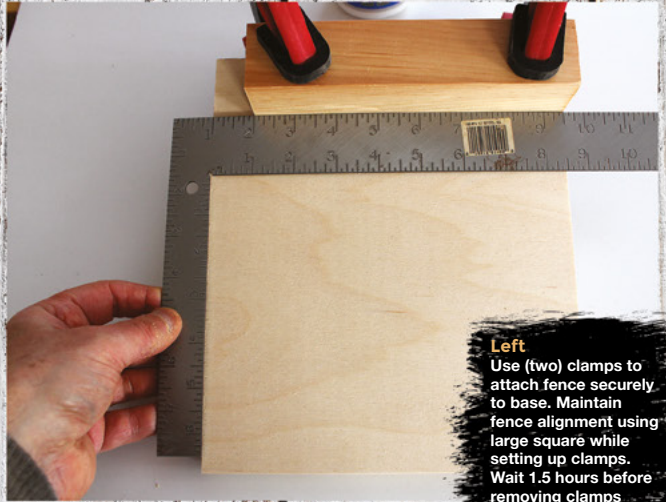

**Left**  
Use (two) clamps to attach fence securely to base. Maintain fence alignment using large square while setting up clamps. Wait 1.5 hours before removing clamps



**Above**  
Side of bench hook showing fence (top) and hook (below) glued to base

## Back saws

A back saw will see regular use in your woodworking. Use it with a bench hook to trim wood. Razor saws are fine-tooth back saws for detail work. I use razor saws to make precise, clean cuts. A common razor saw is 6 in. (150 mm) long with a 24 TPI, 1.5-inch (38 mm) deep blade. A razor saw is an inexpensive back saw found at hobby shops. It creates a thin kerf saw-cut to aid in precision.



## HOW TO MAKE YOUR HOOK

An addition to the bench hook is the stop. Often you'll need components of similar length. A bench hook with a stop excels at creating identical small parts. An adjustable stop ensures repeatability.

Bench hooks can be made narrow or wide, and oriented for left- or right-hand use. The tools to make your first bench hook will be used in every woodworking project.

Start with a plywood base 1/2 inch to 3/4 inch thick (12mm to 18mm). Ensure the sides of base are square or 90° to each other. We used a roughly 15cm x 20cm piece of plywood, but this doesn't have to be exact.

The fence is attached across the top end; the hook is attached at the bottom of the opposite end. Fence and hook attach to a plywood base using glue and clamps. Two short lengths of 2 x 2 lumber (50 mm x





**Above**  
Two saw slots are created to precisely saw a workpiece at a 90-degree or 45-degree angle. Use the back saw you intend to use with the bench hook for this step. Mark a vertical slot 1-inch from fence shoulder



**Above**  
Follow the same sequence to accurately cut a 45-degree kerf in the fence

## Use the shoulder to make open-ended cuts on a workpiece



**Above**  
Mark along the top to create a saw line. Use a combination square to create the lines

Convert the hook into a fence with different angles, or simply to minimise wear on the main fence. The hook should fit over the edge of your workbench.

The fence has a shoulder used as a sawing guide. The shoulder is narrower than the base, preventing a saw from damaging the workbench surface. Use the shoulder to make open-ended cuts on a workpiece. □

50mm) from the fence and the hook. Before gluing, the fence is aligned to the base using a square. To install the fence, use a square and orient it along the side of the base. This becomes the reference surface. The other leg of the square aligns the fence at 90 degrees to the base.

The bench hook fence should be 1 to 1.5 inches (25mm to 38mm) tall, enabling a saw-blade to register and create square cuts. Back saws have limited depth, so consider saw-blade depth when creating your fence. The hook can also be configured as a fence. The bench hook is flipped over, providing two fences.



**Left**  
A 45-degree mitre being sawn in a small furniture component



# SUBSCRIBE TODAY FROM ONLY £5



## SAVE UP TO 35%

Subscribe today and get:

- ▶ **FREE delivery**  
Get it fast and for FREE
- ▶ **Exclusive offers**  
Great gifts, offers, and discounts
- ▶ **Great savings**  
Save up to 35% compared to stores

➤ **Subscribe online:** [hsmag.cc/subscribe](https://hsmag.cc/subscribe)



# SUBSCRIBE TODAY

Subscribe for 12 months

Rolling monthly subscription

£55 (UK)

\$60 (USA)

£80 (EU)

£95 (Rest of World)

Free Circuit Playground Express with 12-month upfront subscription only (no Circuit Playground Express with rolling monthly subscription)

▶ Low monthly cost (from £5)

▶ Cancel at any time

▶ Free delivery to your door

▶ Available worldwide

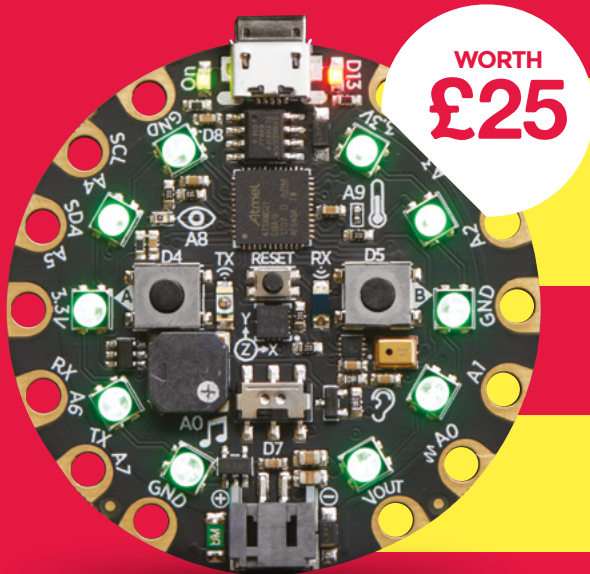

# FREE!

## Adafruit Circuit Playground Express

With your 12-month print subscription

This is a limited offer. Offer subject to change or withdrawal at any time.

# SUBSCRIBE on app stores

From **£2.29**



👉 Buy now: [hsmag.cc/subscribe](http://hsmag.cc/subscribe)





# How I Made BINDAYCATOR

Never forget to put the rubbish out again

By Darren Tarbard

**A** rainbow of wheelie bins is a common sight on our streets now. Recycling continues to grow in importance, with councils

issuing multiple colour-coded bins for us to separate our refuse. Councils can't collect every bin every week, and so they are collected on a rota, one or two each week.

Like most people, I used the usual 'algorithm' of just seeing what the neighbours put out. It works, but there have been times where a couple of people put out the wrong bins, and the rest of the street followed. Crowdsourcing data is great, but it isn't always accurate, and in the dark of winter, it's hard to make out colours. You might even totally forget, and end up chasing the bin lorry in your pyjamas at 7 am.

The correct thing to do, of course, is to visit the council website to find out what bin



Above  
Never miss your  
bin collection again

is due, providing you remember to, but I'd been toying with the idea of making something to remind me for a while. Just before Christmas, I forgot to put out the cardboard and paper bin and, as more

cardboard accrued, it sat in a corner, taunting me over the holiday period.

The obvious choice would be a program which sent me an email or notification on my phone, but it's easy to miss yet another notification in the constant flow, and I had a more novel idea. The idea of a bin-shaped lamp intrigued me; it would check the council's data and change to the colour of the due bin, pulsing on the correct day.

In a world where information, alerts, and indicators have been absorbed into all-conquering touchscreens, I thought it would be a pleasant change.

## HARDWARE

When I have a new idea, I first try to prove the concept is sound. I start with the



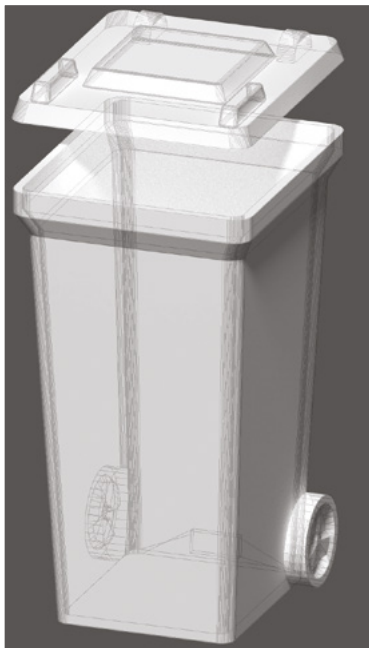

**Above** ♦  
Designing our notifier

least-known or most difficult feature first and try the simplest prototype. Using this approach, you can find out quickly whether something is feasible or not rather than spending a lot of time on up-front design only to discover it won't work later on. I often make things out of cardboard or other scrap so that I can quickly try ideas.

For this project, the aspect I needed to explore was how good it would actually look. In my head, I had an image of a bin glowing a nice evenly-lit colour, but would this translate to reality, or would it just look like a few LEDs inside a box? Luckily for me, there was already a bin model on Thingiverse – it wasn't the right size or appearance for what I wanted, but good enough to test with. I printed it using white PLA, which was perfect for diffusing while still allowing a lot of light to transmit through. I soldered up a strand of NeoPixels and breadboarded it up to an Arduino to try out. Success, of sorts – the PLA produced just the right kind of glow, but to produce multiple colours, I would require more than just a hollow bin shape.

I used Blender to start constructing my own wheelee bin from scratch; now I could tailor it to exactly the right dimensions,

## The idea of a bin-shaped lamp intrigued me; it would check the council's data and change to the colour of the due bin

include a port for the USB connector, and include a light baffle structure to help shape the lighting. Iteration was the name of the game now, printing multiple versions until I was happy with how the electronics would fit inside, and perfecting the lighting and finish.

Printing a single bin in its entirety at good quality took seven hours, which is a long time to wait to get feedback. So, one technique I used was to only print part of the bin, depending on which aspect I was changing. For example, I might just print the bottom quarter because it's enough to check for electronics fit. Like everyone who does

3D printing, I had my fair share of print failures, but I tried to make use of failed prints too by patching them up and using them to test while the next version printed.

Since this project would need WiFi connectivity, I switched from an Uno to an ESP8266-based Wemos D1 Mini. These boards are small, powerful, include WiFi, and are relatively cheap. Their main downside is a limited amount of GPIO, but for this project, I only needed one pin. A bonus feature of >

**Below** ♦  
If only we knew when to take these bins out





## FEATURE

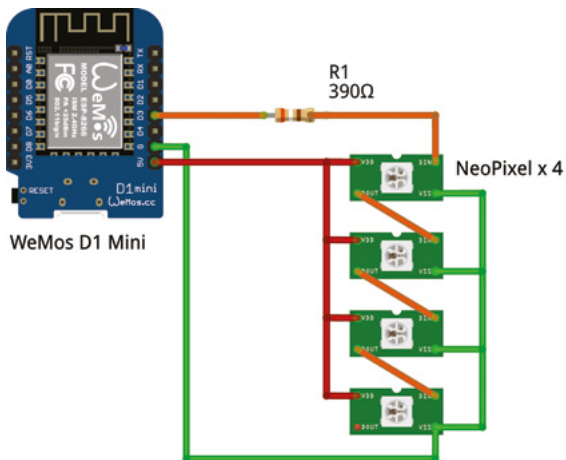
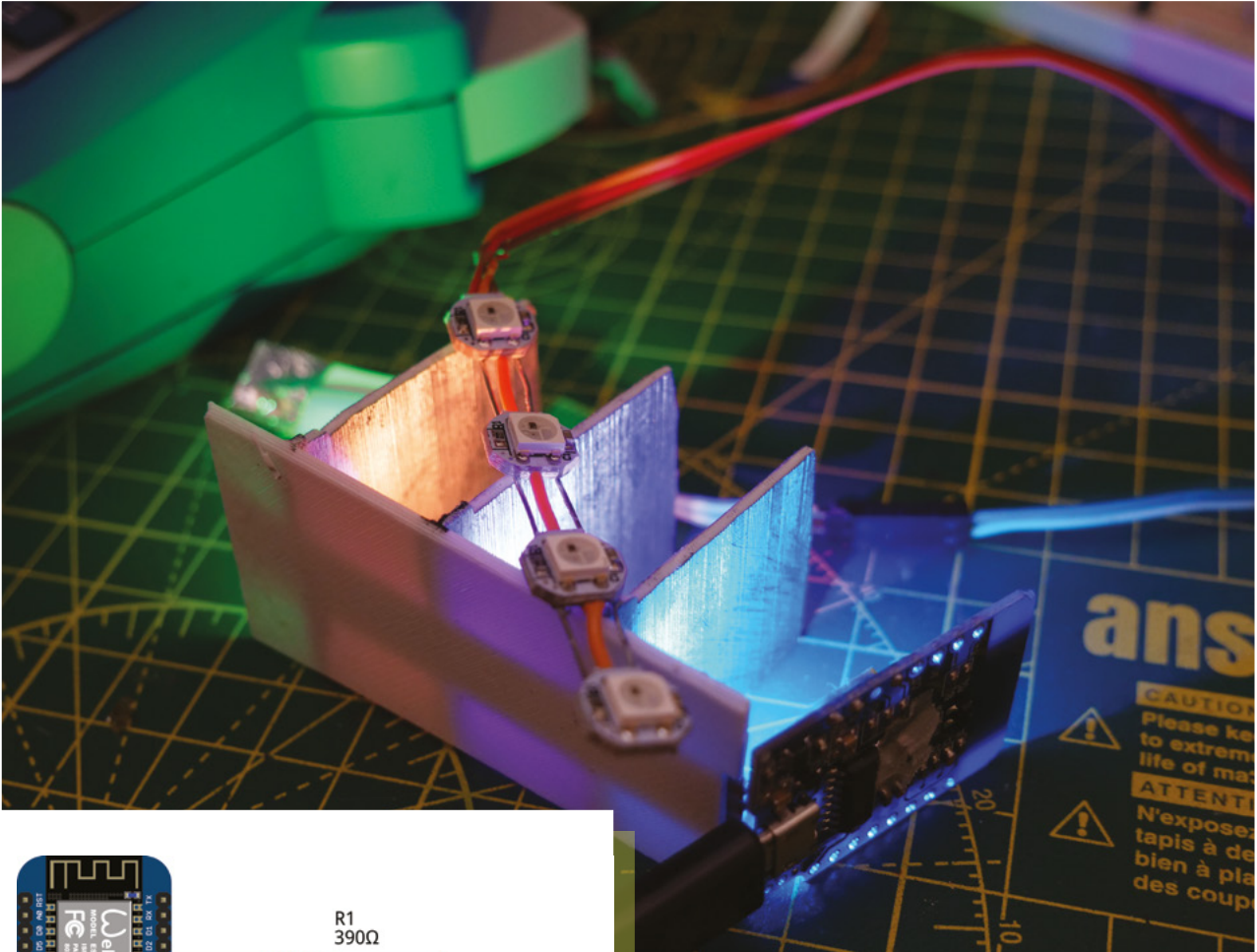

having WiFi is you can reprogram them over the network using the Arduino OTA library – handy when your prototype lives in the kitchen next to the bins, and far away from your PC.

I'd posted pictures of my device on social media, and it had really struck a chord – being shared widely, prompting much

discussion on the subject. People really liked the idea and the issue resonated with them on some level, even if it was just the novelty factor. A government department and media outlets were interested too, and wanted demonstration units, so now my focus was on producing a more high-quality finish and a web interface for demonstrating.

Layer lines can be an interesting texture, but I wanted a smooth finish because when it glows, you can see every line. Every other imperfection stood out clearly, too. You can say goodbye to that seven-hour print because of a single cat hair sandwiched between layers during printing. Support structures also left imperfections on the print. So, I spent a while trying a range of supports, from standard Cura supports to the organic-looking, tree-like supports that Meshmixer could produce. I tried vapour smoothing to remove layer lines, a technique normally used with ABS, but not so much with PLA. ABS can be smoothed using commonly available acetone, but PLA doesn't react to it, and so I went through a number of increasingly uncommon (and unpleasant) chemicals. The best solvent I found was called dichloromethane – it was difficult to work with and hard to store since

**Above** ♦ A prototype in progress

**Left** ♦ The electronics is quite simple





Left ♦  
A collection of hazardous chemicals

Below ♦  
Sanding the indicator smooth

## I tried vapour smoothing to remove layer lines, a technique normally used with ABS, but not so much with PLA

it has a tendency to slowly leak through or melt most bottles. I still wasn't happy with the result and gave up on vapour smoothing entirely for this project. My experiments weren't a waste of time because I learned a lot, including that this particular solvent was useful for gluing parts together by melting them slightly – a technique called 'solvent welding'.

I settled on old-fashioned wet sanding to be the best approach. Nobody likes sanding, but it worked well here, using increasingly fine grits to polish it and then coating the surface with matt varnish.

### SOFTWARE

The council publishes which bins are due for collection on its website, but the page was designed for people, not software, to read. If you view source on most webpages, you

will see it is a sea of hard-to-read HTML – writing code to deal with this is challenging. Luckily this problem has already been solved using a technique called 'screen scraping' which allows a computer to read information usually designed for humans to read. Using a screen-scraping library will filter out unneeded data and let you extract just the bit you want.

Despite the ESP8266 being a fairly fast microcontroller, it would still struggle under the pressure of downloading and parsing large >





# How I Made: BinDayCator

## FEATURE

webpages. I already had a Node-RED server running all the time, so it made sense for me to use that because a faster CPU would make development smoother. If I'd wanted to do it all on the same device then a Raspberry Pi Zero could have controlled the NeoPixels and done the screen scraping on one device, but it would make my enclosure larger, and it would be harder to hide the electronics.

Node-RED is a programming tool for wiring together hardware and services – it has a nice graphical interface that lets you

drag and drop nodes. Nodes are building blocks with certain functionality, and you create logic by connecting them. I checked through the node types it had, and I was in luck – it had two nodes with the features I wanted. One node, the HTTP Request node, could retrieve the webpage, and the HTML node would do the screen scraping based on a selector I gave it. I configured it with the council's webpage URL and started looking for the correct selector. Selectors use CSS (Cascading Style Sheets) syntax to specify which part of the page to extract.

Modern browsers make this easy to find with their developer tools – you can click on a part of a webpage, and it will tell you what the selector is for on that area of the page.

Armed with this selector, I plugged it into the HTML node, attached a debug node so I could see the result, and deployed the flow. This worked great, and it delivered me the contents of that part of the page. The council use a descriptive heading for the bins and not the colours, so I added a JavaScript node which converts the name to a colour.

I coded the BinDayCator device to connect to Node-RED using the HttpClient library, which would read the previously stored colours and return them to the device. A JSON library is then used to process this string back into an array and set the NeoPixels to the appropriate colours.

Having a constant ambient indicator had advantages I hadn't expected; it helped me to plan ahead. For example, if it was garden

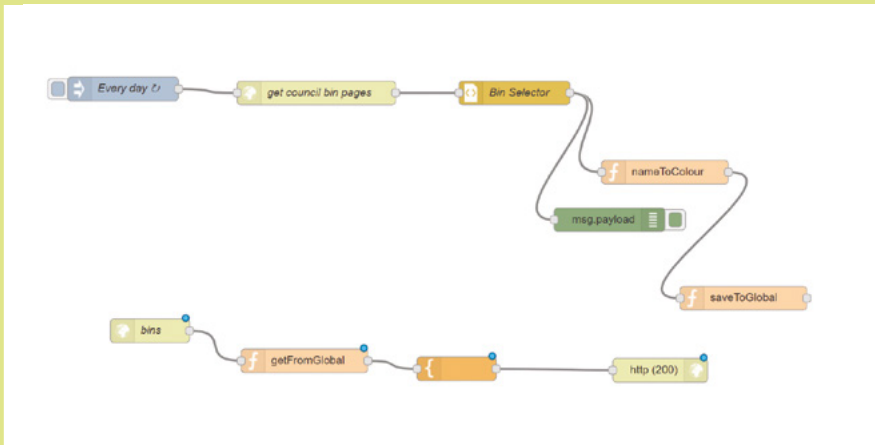

Left ♦ Node-RED does the heavy lifting of the data collection

Below ♦ Web pages weren't meant to be read by machines

### Cedar Crescent, Hamilton

h4 325.65 x 106.89

Glass, cans and plastics  
No ceramic, light bulbs, polystyrene or plastic bags. [More info](#)



| Area                               | Hamilton                |
|------------------------------------|-------------------------|
| Black/Green - Non Recyclable Waste | Wednesday (Fortnightly) |

```
"bins and recycling">
<meta name="description" content="South Lanarkshire Council's Cedar Crescent, Hamilton Information | ">
<meta name="keywords" content=">
<title>Cedar Crescent, Hamilton | South Lanarkshire Council</title>
<!--ch2>Record details</h2>
<dl class="item-list item-list--definition"> -->
<div class="serviceDetails">
  <div class="bin-snip clearfix">
    ::before
    <div class="bin-dir-snip">
      <ul>
        <li>
          <ch4> ==
            "Glas
            <br>
            <p>...<
            </h4>
            <img sr
            www_sou
            bin-pre
            </li>
          </ul>
        </div>
        ::after
      </div>
    ... #main-section div #lower-cont
    Console What's New X
    Highlights from the Chrome 79 update
    Store as global variable
```

Styles Computed Event Listeners

Filter #hov .cls

```
element.style {
}
#documentsInfo #content style.min.css
#main-content .bin-snip .bin-dir-snip h4,
#directoryRecord #content #main-content .bin-snip .bin-dir-snip h4 {
  margin: > 0;
  font-size: 1.2em;
  border: > 0;
  text-shadow:
  0 1px 1px rgba(0,0,0,0.25);
}
h1, h2, h3, h4, h5, h6 { style.min.css:14
  color: #1E4C85;
}
h1, h2, h3, h4, h5, h6 { style.min.css
  elem-- #24590a;
}
h5, h6 { style.min.css
  normal;
}
h1, h2, h3, h4, h5, h6 { style.min.css
  m-0;
}
user-agent stylesh
h1, h2, h3, h4, h5, h6 {
  start: 1.33em;
  end: 1.33em;
}
```



waste that week, I could prioritise gardening since I knew it was due to be collected.

My post was shared widely, and people asked if they could buy one. I'd only made it for myself, but it seemed unappreciative to ignore people's interest. The cost of setting up manufacturing was significant as I would need to have moulds made for production runs, and I also needed a critical mass to make the server-side code worth creating. I would need to create a BinDayCator server on the internet that could process councils' webpages, all of which had different formats. I launched a Kickstarter as soon as I could to prove the demand for this product. If I had enough customers, it could work. Unfortunately, the Kickstarter failed to meet its goal, but I did learn an awful lot. I'd never created a Kickstarter before, and that was almost an entire project in itself.

Councils and companies were interested in providing BinDayCators for their users, but none have yet wanted a big enough rollout for the critical mass needed for manufacturing. Big organisations have a lot of inertia because they have a lot of factors to consider, something makers are not encumbered with. We can just imagine it, make it, and use it. □



**Above** □  
Time to take a trip to the pavement

**Right** ◆  
Dividers let us light up our indicator in sections



# IN THE WORKSHOP: Lit lithophanes

By Ben Everard

Bringing an unborn child into bright 3D

**T**

**his editor is about to become a father for the second time and, like many expectant fathers, he went to the ultrasound scan. At the end of which he got a little printout of the baby in utero.**

It's a magical experience, but the printout leaves a little to be desired. It's done by a thermal printer in monochrome. Is there a better way of representing an unborn child? Time to get to the workshop to see how we can use the render.

Lithophanes are one of our favourite methods of displaying monochrome data. The basic idea behind them is that they're a material that varies in thickness. When light is shone through, the thicker parts appear darker, and the thinner parts appear lighter. Traditionally, these are handmade out of ceramic, but we can 3D-print them using translucent filament.

The key part of the aesthetic of lithophanes is how they're lit. There are loads of options for this – some people turn them into lampshades, some mount

them in back-lit frames. We wanted a small, evenly lit option to add the image of our unborn child to our workshop, and we came across the ideal solution in the form of LCD back-lights. These are designed to go behind LCDs and provide illumination. They should give even light across a rectangular area, and some electronics suppliers sell them. The downside of these is that they only come in the sizes of common LCDs – these tend to be a bit longer and thinner than most photographs, but are perfect for images of reclining foetuses.

We got an 84 × 45 mm light, so all we needed to do was



Right ♦  
The final lithophane at home in our workshop



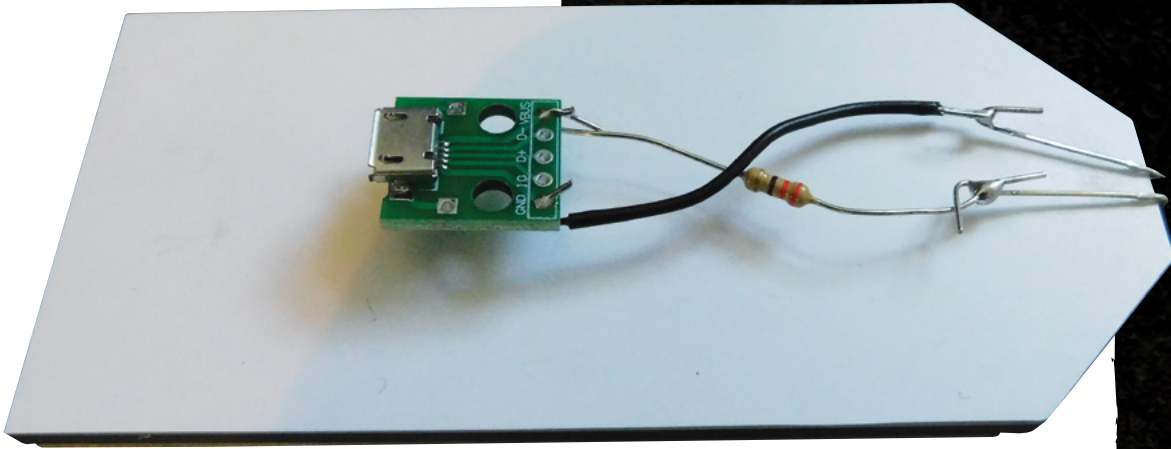

crop our image to the same aspect resolution as this, then upload the image to a lithophane generator. There are a few available online, but we used the one at [3dp.rocks/lithophane](https://3dp.rocks/lithophane). This provides some options of different shapes that might be useful if you're trying to use your lithophane in different ways, but we went with just a flat lithophane.

This generates an STL file that we can import into our slicer as with any usual 3D print file. In the slicer (we used Prusa Slicer, but any should work), you can scale the object to exactly  $82 \times 45$  mm. We had to unlock the aspect ratio as it ended up being out by about 1 mm without this, but it's not noticeable in the final print.

Common wisdom dictates that you should print your lithophanes vertically, as this will give you better resolution (a large brim will help it stay attached to the print bed). We tried out a few ways of printing and for this style of image (where most parts are either very black or very white), we didn't notice much difference between them printing vertically and horizontally (other than they printed much faster when lying flat to the print bed).

A few dots of superglue attached the lithophane to the back-light (we put them in areas that were dark so they didn't affect the image in any noticeable way). That's the image set up – we just need a way of providing power.

The back-light is basically just a white LED, plus appropriate diffusers and reflectors, so powering it is just the same as powering an LED (even down to the fact that they have a long leg and a short leg). Like many people, we have stacks of USB chargers lying around, so this was the obvious choice for sending electrons in. All we needed was a micro USB breakout board (these are available cheaply from a wide variety of vendors online) and a single 220 ohm resistor to limit the current.

We soldered these up, but needed a way to insulate the bare wires – after all, we didn't want to put it down on a metal surface and accidentally short it out. We decided to use the hack-y option and cover everything in hot glue. It's not an ideal solution, but it does work. Fortunately, we've been able to hide all the glue on the back, and who looks at the backs of pictures anyway? →

**Above** ☑  
The circuit on the back is just the power connected to the LED with a resistor

**Below** ⚡  
If your aspect ratio isn't quite right, you can stretch it a little when doing the print scaling

The key part of the aesthetic of lithophanes is how they're lit

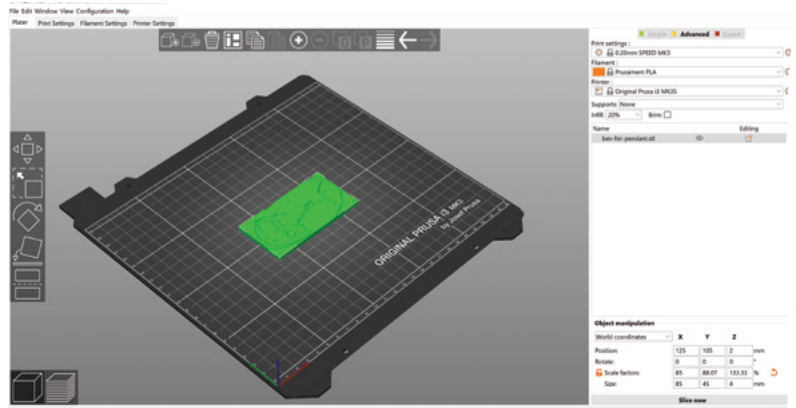



# Infinite Bunner game controller

Control your character by tilting a Circuit Playground device

**L**

**ast month, we had a look at how to create an ultrasonic controller for a version of Pong called Boing!**

This month, we're going to take a step further forward through video game history and look at the game

Frogger. In this classic game, you control a frog as it makes its way across logs, roads, and train tracks, avoiding falling in the water or getting hit.

The tribute to this game in the new *Code the Classics Volume 1* book (available from [hsmag.cc/VTTzPH](http://hsmag.cc/VTTzPH)) is called Infinite Bunner, and works in much the same way, except you control a bunny. All this hopping got us thinking about a controller. Our initial idea was that since the animals jump, so should the controller. The accelerometer can detect freefall, so it shouldn't be too hard to convert those into button presses. However, it turns out that computer-controlled frogs and rabbits can jump much, much faster than humans can, and we really struggled to get a working game mechanic, so we compromised a little and worked with 'flicks'.

The basic idea is that you tilt the controller left or right to move left or right, but you have to flick it up to register a jump (simply holding it upright won't work).

We've used a Circuit Playground Bluefruit for this, but it will work equally well with a Circuit Playground Express. There are two key parts to the software. The first is that you can read in accelerometer values and use these to know what orientation the board is in, and the second is that the board can mimic a USB keyboard and send keystrokes to any software running on it.

The first step is to get Infinite Bunner working on your machine. You can download the code for all the *Code the Classics Volume 1* games from [hsmag.cc/w2LiEg](http://hsmag.cc/w2LiEg). Press Clone or Download >

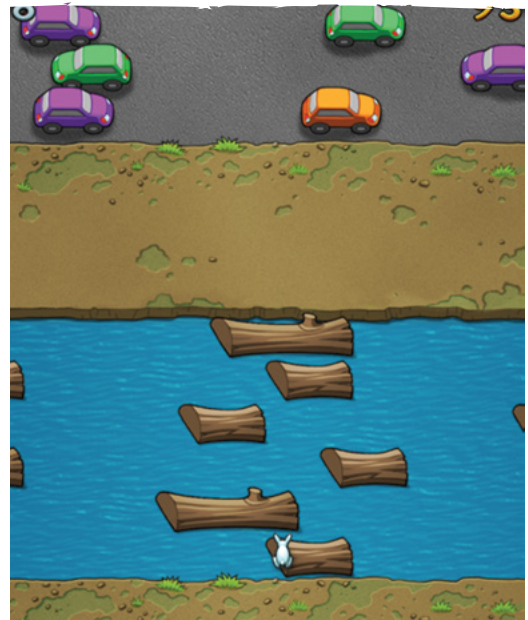

Download ZIP. Unzip this somewhere. You'll need Python 3 with Pygame Zero installed. The process for this differs a little between different computers, but there's a good overview of all the different options on page 186 of *Code the Classics*.

Once everything's set up, open a terminal and navigate to the directory you unzipped the code in. Then, inside that, you should find **bunner-master** and enter that. You can then run:

```
python3 bunner.py
```

Have a few goes playing the game, and you'll find that you need the left, right, and up arrow keys to play (there is also the down arrow, but we've ignored this since we've never actually used it in gameplay

**Right** ↗  
Jump along the logs, dodge the traffic, avoid the trains, and keep your bunny alive for as long as possible



– if you're a Frogger/Bunner aficionado, you may wish to implement this as well).

Reading the accelerometer is as easy as importing the appropriate module and running one line:

```
from adafruit_circuitplayground import cp
x, y, z = cp.acceleration
```

Sending key presses is similarly easy. You can set up a keyboard with the following:

```
from adafruit_hid.keyboard import Keyboard
from adafruit_hid.keyboard_layout_us import KeyboardLayoutUS
from adafruit_hid.keycode import Keycode

keyboard = Keyboard(usb_hid.devices)
```

Then send key presses with code such as this:

```
time.keyboard.press(Keycode.LEFT_ARROW)
time.sleep(0.1)
keyboard.release_all()
```

The only thing left is to slot in our mechanics. The X-axis on the accelerometer can determine if the controller is tilted left or right. The output is between 10 (all the way left) and -10 (all the way right). We chose to threshold it at 7 and -7 to require the user to tilt it most of the way. There's a little bit of fuzz in the readings, especially as the user flicks the controller up, so having a high threshold helps avoid erroneous readings.

The Y-axis is for jumping. In this case, we require a 'flap' where the user first lifts it up (over a threshold of 5), then back down again.

The full code for our controller is:

```
import time
from adafruit_circuitplayground import cp
import usb_hid
from adafruit_hid.keyboard import Keyboard
from adafruit_hid.keyboard_layout_us import KeyboardLayoutUS
from adafruit_hid.keycode import Keycode

keyboard = Keyboard(usb_hid.devices)

jumping = 0
up=False
while True:
    x, y, z = cp.acceleration
    if abs(y) > 5:
        up=True
    if y < 5 and up:
        keyboard.press(Keycode.UP_ARROW)
```

```
import time
from adafruit_circuitplayground import cp
import usb_hid
from adafruit_hid.keyboard import Keyboard
from adafruit_hid.keyboard_layout_us import KeyboardLayoutUS
from adafruit_hid.keycode import Keycode

keyboard = Keyboard(usb_hid.devices)

jumping = 0
up=False
while True:
    x, y, z = cp.acceleration
    print((x,y,z))
    if abs(y) > 5:
        up=True
    if abs(y) < 5 and up:
        print("jump")
        keyboard.press(Keycode.UP_ARROW)
        time.sleep(0.3)
        keyboard.release_all()
        up=False
    if x < -7:
```

```
        time.sleep(0.3)
        keyboard.release_all()
        up=False
    if x < -7 :
        keyboard.press(Keycode.LEFT_ARROW)
        time.sleep(0.1)
        keyboard.release_all()
    if x > 7 :
        keyboard.press(Keycode.RIGHT_ARROW)
        time.sleep(0.1)
        keyboard.release_all()
    time.sleep(0.1)
    if jumping > 0: jumping=jumping-1
```

The final challenge we had was that there's a bit of wobble when moving the controller around – especially when trying to jump repeatedly and quickly. After fiddling with thresholds for a while, we found that there's a much simpler solution: increase the weight of the controller. The easiest way to do this is to place it inside a book. If you've ever held a copy of *Code the Classics*, you'll know that it's a fairly weighty tome. Just place the board inside and close the book around it, and all the jitter disappears.

That's all there is to the controller. You can use it to play the game, just as you would any joystick. Start the game as usual, then start flapping the book around to get hopping. □

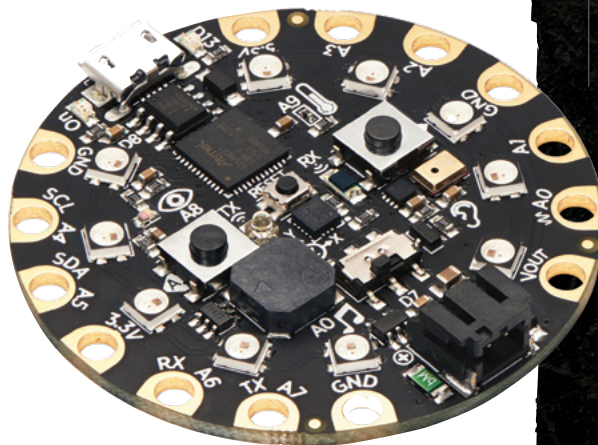

**Above** ☑  
It doesn't take much CircuitPython to convert a microcontroller into a games controller

**Below** ☑  
Subscribe to HackSpace magazine for twelve months and you get a Circuit Playground Express for free – you can make your very own Infinite Bunner controller



HackSpace magazine meets...

# Charlie Bethel

Putting making on the front line of mental health

---

**Y**ou might have heard of **Men's Sheds** and assumed quite reasonably, that they are... sheds. Wooden structures big enough to store a lawn-mower and some gardening equipment, with maybe space left over for a chair and a radio. There's much more to them than that. Men's Sheds provide a place to work, with tools (like a makerspace), a social outlet, full of like-minded people sharing expertise (again, like a makerspace), and most crucially, they share a mission to improve the well-being and mental health of men around the world.

We spoke to Charlie Bethel, Chief Officer of the UK Men's Sheds Association, to find out why sheds are so important, what they offer that other places don't, and what the benefits are of getting together and making things. →





**Above** 

The UK Men's Sheds Association has signed up to the Manchester Declaration, a campaign that calls for the right to repair our own stuff

**Images**

Paul Carroll



**HackSpace** Let's start at the very beginning: what is a shed?

**Charlie Bethel** Sheds are basically safe spaces where men and women can make, do, repair, or repurpose things. Shed members will do projects for themselves in the sheds, or for communities, charities, or local schools and, as a result of doing those individual things, it gives the people going to those sheds (who are called shedders) a purpose. And it's that sense of purpose that is key.

The shed has also been referred to as a form of therapy that dare not speak its name, but that's not why people go. People go to help somebody else, or to make something. But as a result of that, you've got people working shoulder to shoulder. Men don't talk face to face; we talk shoulder to shoulder. Shoulder to shoulder, a man will share his feelings potentially more than he would if he went to the bingo hall or somewhere else.

Part of the problem we find with retired men is that men generally (and I must say at this point that it's all generalisations), men will often go and live where their wife is from, and their friends at home are very often their wife's friends or their partners. If their wife passes away or there is another change in life circumstances, the guy can end up quite lonely and isolated. The shed can provide a social opportunity and fill that gap.

One example of why sheds work is that if you put twelve men in a room and say "talk about your emotions", six would leave, and six would try to find a corner. If you say to the twelve men, "There's a lawnmower, can you fix it?", they'll know each other intimately. They'll know how many children or grandchildren each person has, who's going to see the doctor, everyone's ailments, how they take their tea... and you might get a fixed lawnmower. That's the best way of describing how a shed works. We're taken off-guard because we're doing something else.

That focus on achieving something is the principal reason that we feel sheds give the well-being benefits they do. They remove the obstacles you would have in day to day engagement with others.

**HS** Can you measure the impact on well-being that sheds make?

**CB** The stats are: 75% reduction in anxiety, 89% reduction in depression, and 96% reduction in loneliness. The act of doing something for somebody else creates focus and purpose, and that then has an effect on your wellbeing in terms of reducing depression and loneliness, which can be so interwoven anyway.

“

Sheds are basically safe spaces where men and women can make, do, repair, or repurpose things

”

If you take this impact further, we then have anecdotal stories of the impact of sheds in terms of reducing suicide, or stopping people killing themselves by suicide. The statistics say that suicide is the biggest single killer of men under the age of 45. 75% of all suicides are men. It's a massive issue, and one that we don't talk about; one, because we're men, and two, because we don't have the same exposure that other groups that have been disadvantaged in society have. And so Men's Sheds do have to shout that, and that's why we keep the word 'men' in our name, even though each shed is autonomous and can accept whoever they like. The men-only session is really important for men to be themselves and something we promote.

There was a guy who went to one shed, didn't really engage with the other

shedders too much, said 'hello', did his own thing, and after three months he turned round to the leader and said, "Do you know I was going to kill myself before I came here?" And the guy who runs that shed said, "Job done". If I do nothing else with my life, that's a good job done.

Now that guy is working again; he's in society, he's got a house, he's fully back, engaged having been disenfranchised from life. We're certainly not the solution; but we're part of the solution.

**HS** What goes on in a typical shed?

**CB** Sheds, like makerspaces, are very different from one another. You might go to one where the majority of things happening are to do with wood-turning. There will be other sheds that have sewing machines, electronics, a whole variety of things.

A key observation is that the shed is doctrine-free. Each shed is autonomous, which is a tremendous strength. It's alive; it can develop and grow in different areas. Some sheds are 200 shedders-strong in big industrial units. Other sheds may actually be in sheds; others are in cargo containers, some are in repurposed toilet blocks; we've got sheds in morgues, sheds in railway stations – we work with the Railway Heritage Trust on that. It's a symbiotic relationship: they want people in their properties, to help maintain and keep the spaces safe and clean. We've got one shed in a school where they support the caretaker in the school, and as a result of that, they get their facilities at a peppercorn rent. I'm sure the shed has saved the school thousands of pounds, and the shedders are happy to help.

**HS** Who goes to a typical shed?

**CB** These are guys who like to take things apart and put them back together again. The majority of shedders are over →





Above  Sheds are a great social leveller – you get someone who's been long-term unemployed working with the mayor, working with the local dentist





**Above** ☑  
Sheds are open over 200,000 hours every year – that's over 2m shedder hours a year





the age of 50. Some sheds have junior sections, and one of our aspirations is to get sheds into universities, so that it becomes the norm to have somewhere to go to let off steam, to relax. There aren't many places you can go to do that, if you're a man, that aren't based on either alcohol or sport.

Sheds will change and develop; some sheds have an area for board-games. We have some shedders with dementia who will go and just sand a bit of wood or just go there to talk. It provides an outlet that you wouldn't get in society normally.

**HS** When did the Sheds Movement start?

**CB** The first sheds started to appear in the UK in 2009, and the UK Men's Sheds Association appeared a couple of years later. The movement that we have in the UK was founded by Mike Jenn. His son was in Australia, saw the concept of men's sheds working over there, phoned his dad, and told him about it. He established his shed and as a result of that we have UK Men's Sheds.

**HS** It sounds like the well-being effect was always the point, rather than being a happy accident.

**CB** Yes. In Australia that's why the initiative was set up. It's a concept that has been around for a while, but the modern movement is Australian. Australian culture is slightly different to the UK. There were a lot of farmers living on their own, very disparate geographically. Sheds were developed to bring people together. There are over 1000 sheds in Australia, open and running. Some of them are absolutely huge.

That concept was a positive well-being piece. In Ireland, they concentrate a lot on the health and loneliness aspects. Here, we focus on getting people into sheds because it's making and doing. We don't shy away from the fact that there are positive well-being benefits to sheds, and to the people who use them. But it is essentially about >





**Above** ♦ UKMSA is a small team of three and half people – “We’re bubble-up rather than bubble down”, as Charlie puts it.

PLEASE  
3/7



exploring your skills and helping others through making, repairing etc. The other thing that we do is put shedders and charities in touch with one another. Prostate Cancer UK, for instance, use us as a way of getting their messages out.

We have an event called ShedFest once a year, which we are looking to expand to twice a year. We were lucky enough to have Paul Sellers last year [if you haven't watched any of Paul's woodworking videos on YouTube yet, do so as soon as you've finished reading this]. It was truly inspirational. He talked very much about love. I heard the Surgeon General of the US talk at a campaign to end loneliness conference, and again he spoke about the opposite of loneliness as being love; so it was quite life-affirming to hear the same message from a master woodworker.

We also had people lead workshops on how to fundraise, how to promote yourselves better, health and safety, and then we also had charities alongside people demonstrating, like the blind wood-turner, Chris Fisher, who has just become one of our patrons. He's the first blind person to be accepted into the memberships of the history of the Worshipful Company of Turners in their history. He's a phenomenal person.

We had charities come along from the fields of deafness, prostate cancer, Parkinson's, and many other organisations there to offer support, so that the guys will be more aware of common illnesses, the signs of them, and how to check for them. It all has a positive impact on the shed, but also on the individuals in those sheds. It's a great communicative system. It's great to think that we might be saving people's lives because they go for a check-up after visiting their local shed.

It's odd isn't it, talking about a shed, a wooden structure having a positive impact on people? But it's more than four walls. It's a group of people coming together.

**HS** What's the growth rate been like recently?

**CB** At the end of 2016, we had 320 sheds. We celebrated 500 last summer, and we're fast approaching 600 in the UK. We don't do the making of the sheds. What we try to do is stimulate local authorities and local groups to do that. We help facilitate with tools and fact sheets, but don't have the capacity to set up each shed.

I have to admit, one of the challenges we have is the word 'men' in our title. We've tried to work with some organisations, one of which owns an awful lot of properties, but because we've got the word 'men' in our title, they've felt that working with us was not in keeping with the values of their organisation. We

It's odd isn't it, talking about a shed, a wooden structure having a positive impact on people?

respect that anyone can have that view, political correctness has its place. We do however go back to the stats of male suicide: if you're trying to deal with men's health, then Men's Sheds is one of those solutions. So I personally struggle with that approach when you delve into what will actually make a difference.

A purely personal view – I worked in disability sport for many years and I've always bought into the idea of the best person for the job. The attitude some people have to us using the word 'men' is worrying and a concern. We live in a society where it has been acceptable and actually the norm to accept people saying 'come on, boys don't cry'. If we are not free to express our emotions, what might the impact actually be?

It's a way that people of an age might have been brought up. Is it cultural? I'm

not a psychologist, but I know that if you put people in a safe environment, they'll open up. We see it in sheds, and you probably see it in makerspaces, and you see it in Morris Minor clubs, the allotment... but you might not see it on the rugby pitch or a football pitch.

It's interesting how we behave as human beings in different environments, with our bravado and everything else. So that's why we use the phrase 'safe spaces'. It's not safe in a mollycoddling way. It's safe because it's somewhere to be yourself.

**HS** That comparison with football is an interesting one. One thing that I find time and again talking to makers is that they want to help and encourage others. You don't get that when you're trying to beat someone at a contact sport.

**CB** Sports clubs are generally competitive in my experience. And not just competitive on the court or on the pitch; they're competitive in terms of not sharing who their sponsors are or what their training regimes are, because you want to beat the others. It's all about more, more, more – and that makes sense. What I've discovered with

sheds is that Shed 1 will tell Shed 2 where it got its money from, it will give Shed 2 its application forms to use, it will share its governance documents, everything. Yes, it will show off the things it's made, but it'll also tell Shed 2 that it's got some spare tools and it's welcome to borrow them. It's incredible. No shed will say, "I get that wood from a secret place, and I'm not telling you".

And I have to say the people we get to come and present at ShedFest, they are more than happy to be there at the crack of dawn to show their wares and skills and help other people. There's one guy, Simon Clements, he's a sculptor in Oxford. He spent hours talking to a guy with reduced hand function about how he might do carving using other tools than a chisel. He was happy to give that time and support. People are fantastic. □



# PLAYING CARDS



There's more than one way to enjoy a deck



Mayank Sharma

[@geekybodhi](#)

Mayank is a Padawan maker with an irrational fear of drills. He likes to replicate electronic builds, and gets a kick out of hacking everyday objects creatively.

**P**

laying cards have a long history that dates back several centuries. While their exact origin remains a matter of speculation, most historians agree that playing cards were invented by the Chinese during the Tang dynasty, in or around the 9th century. Another inconstant aspect has been the number of cards in a deck. There have been several variations over the centuries, with the popular ones being 24, 32, and 48 cards.

The variations continued to flourish even after the deck made its way into Europe sometime in the 14th century. For suits, the Italians used cups, swords, coins, and batons; the Germans used acorns, leaves, hearts, and bells; and the Spanish preferred coins, cups, swords, and cudgels. In the end, it was the French suits of spades, hearts, clubs, and diamonds that stuck. The 52-card deck was a French variation as well, which was taken all over the world by the French colonialists until it became the standard.

French card decks are modelled after renowned historical figures. The King of Hearts is Charlemagne, King of Diamonds is Julius Caesar, King of Clubs is Alexander the Great, and King of Spades is King David from the Bible. The queen cards have had a mixed roster that includes Pallas (warrior goddess; equivalent to the Greek Athena or Roman Minerva), Rachel (biblical mother of Joseph), Argine (an anagram of Regina which is Latin for Queen), and Judith (of the Apocrypha).

Another fascinating aspect of the deck of cards is how they correspond to the calendar. The two colours (red and black) relate to the two parts of a day – namely daytime and night. The four suits correspond to the four seasons of spring, summer, autumn, and winter. There are twelve court cards, just as there are months in a year, and 13 cards in each suit are a match for the number of weeks in each quarter. The 52 cards in the deck correspond to the 52 weeks in a year and, if you add up all the values of the cards in a deck (assuming 11 for the Jack, 12 for the Queen, 13 for the King), plus add one for the Joker, you end up with the exact number of days in a year – 365.

**"THE VARIATIONS CONTINUED TO FLOURISH EVEN AFTER THE DECK MADE ITS WAY INTO EUROPE SOMETIME IN THE 14TH CENTURY"**

While the first packs were printed on paper and wood, modern-day decks are a marvel of engineering and design. Good-quality playing cards are made of multiple layers of laminated sheets of paper, glued together. The glue does more than to stick the layers together. In fact, it is the glue that gives the playing cards their distinctive snap. And when they lose that snap (the life of a deck in a Las Vegas casino can be as short as an hour), you can count on our inventive makers to put them to good use.



K



# PARTY HATS

A

playing cards connoisseur, **Sergey Chernyshev** knew the cards would lend themselves nicely to a DIY project, and so he decided to create himself a top hat.

He began with the top of the hat, by stapling a string of cards after overlapping them just enough for one staple. Keep stapling the cards to make a line of cards, as per the size of the head, and staple the last card to the first one to close the loop. Depending on the fit, use a stapler remover to add or remove cards. When you've found the correct fitting, unstaple the last card to lay it flat, and then follow Sergey's lead to bend its edges with a ruler. Staple the ends again when you're done. Once the top is ready, it's time to staple a row of cards to create the brim. Sergey suggests you experiment with the cards while adding the rows to make interesting patterns. While you can add as many rows as you please, Sergey says you'll have to use a longer stapler if you plan to add more than two rows. The last step is attaching the brim. For this, you'll first have to bend and cut through the last row of cards, before stapling more cards to the folded-out cut cards. Sergey suggests you staple through the cards at the bottom to strengthen the brim. →

Project Maker

**SERGEY  
CHERNYSHEV**

Project Link

[hsmag.cc/vNfDio](http://hsmag.cc/vNfDio)

Below ♦

Make sure you have at least three full decks, and just as many hours, before you start stapling the hats

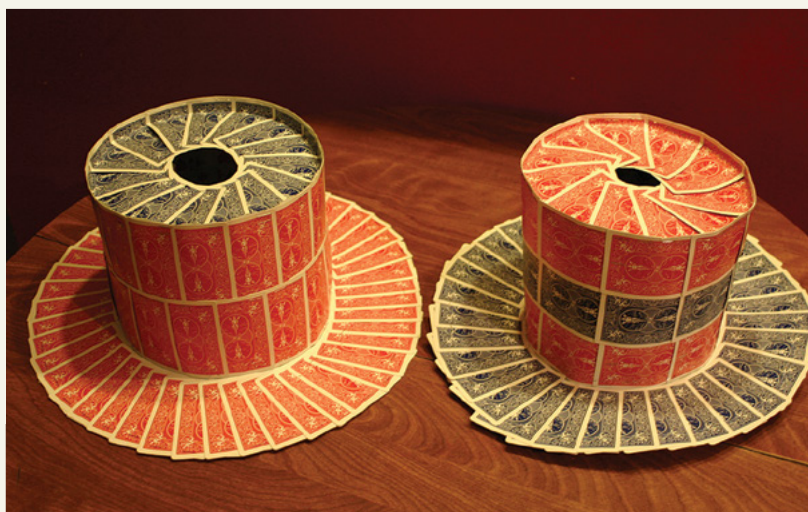





# USB CASE

Project Maker  
**CORY STERRETT**

Project Link  
[hsmag.cc/diJrEU](http://hsmag.cc/diJrEU)



enerally speaking, the card-stock used to make playing cards is pretty good, and can be used for a number of crafts.

If you don't have enough of them to staple into a hat, you can follow Cory Sterrett's lead to use some to create a sturdy, yet fashionable, case for a USB drive. Begin by first collecting a stack of cards equivalent to the thickness of the drive, and pad them by gluing another five cards on either side for structural support. Then, cut the cards in the middle and trace the drive on the inside of the deck with a Sharpie. Cory cautions you not to rush through this step. Make sure that you place the drive on the bottom stack, such that it still has enough room to be plugged into the USB port. Then use a pair of scissors and a craft knife to cut and hollow out the cards to make room for the drive. Don't be fussy about perfecting the cut. Cory says as long as it's wide enough to hold the drive snugly, you should be good. Finally, just glue the drive to the deck before gluing the other deck over it, and you're done.

**Right** ♦ You can also, like Cory, first remove the original outer covering of the USB drive to make it a little more workable





# CONSTRUCTION SET

**A** self-confessed inventor and microfabricator, Daniel Bauen loves to upcycle. In his quest to be able to build stable and complex structures using playing cards that wouldn't tumble down with ease, Daniel came up with a clever design for some cardboard connectors. He suggests using any CAD or vector drawing software to design the connectors. It basically involves a circle that's 35mm in diameter, with lines radiating from the centre at either 15 or 30 degrees. If the lines are spaced at 15 degrees, Daniel suggests you make them alternate between 9mm and 5mm. On the other hand, if you choose to have them at 30 degrees, they can all be

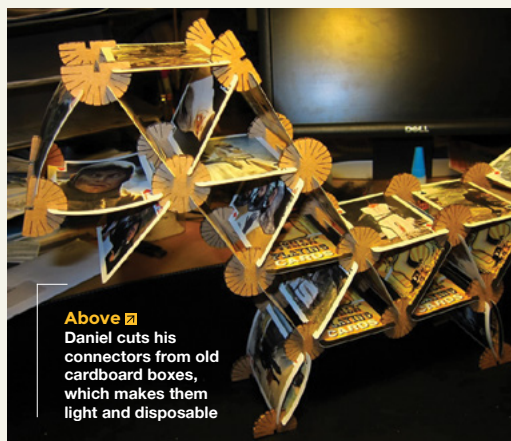

**Above** Daniel cuts his connectors from old cardboard boxes, which makes them light and disposable

9mm. The design is then transferred to a cardboard box using a laser cutter. Make sure to cut several connectors. That's it. You can now plug the playing cards in the spaced slots to create your structures. Check out some of the ideas on Daniel's Instructables page for some inspiration.



**Project Maker**  
**DANIEL BAUEN**

**Project Link**  
[hsmag.cc/ajJOMl](http://hsmag.cc/ajJOMl)

# A WALLET

**A** store-bought wallet just didn't cut it for John Andrews. So, he just made himself a cool-looking one using a handful of playing cards and some clear tape. He first tapes together two sets of three cards, each spaced about one quarter of an inch apart. These are then lined up in a 3x2 grid, and taped together with loads of tape for strength. Then, flip them over and tape some more. Now, fold the rows into each other at one end, such that the faces are on the outside, before taping over the short sides. This creates the wallet-like opening at the other end. To add a pocket to this basic wallet, take a card and cut away about 40%. Then, tape the bottom and the sides of the larger piece to the inside of one of the other cards in your wallet, and you have a small pocket in which to slip your library card. □

**Project Maker**  
**JOHN ANDREWS**

**Project Link**  
[hsmag.cc/3y1fdZ](http://hsmag.cc/3y1fdZ)



**Below** The final wallet also has a small fastener to ensure it stays folded, and John suggests leaving it under some weight overnight if it feels too stiff





# Testing NeoPixel Voltages

Find out what these LEDs can handle

By Ben Everard

**If you look at a data sheet for WS2812B RGB LEDs (commonly known as NeoPixels), you'll see that they need an input voltage of between 3.5V and 5.3V, and a signal voltage of at least 0.7\*input voltage.**

The vast majority of microcontrollers now on the market operate at 3.3V, with additional voltage outputs of 5V and 3.3V. This causes a problem because it means that there's no way to connect NeoPixels directly to the microcontroller without going out of these ranges. If you connect the NeoPixels to the 5V power, then they need at least 3.5V to operate, which is more than the microcontroller's data pins output.

Of course, just because a data sheet says that they need at least 0.7\*input voltage, it doesn't mean that they do. Many people connect NeoPixels up directly to 3.3V microcontrollers without problems. Here at HackSpace magazine, we've been wondering what we should advise people to do – follow the data sheet even though that leads to more complexity, or ignore the data sheet and cross our fingers as many people do. We decided to run some tests to see what the actual real-world limits are.

The setup was a fairly simple solution. We used a 5V microcontroller (the Arduino LilyPad Plus USB was the first 5V controller we came across rummaging through the HackSpace

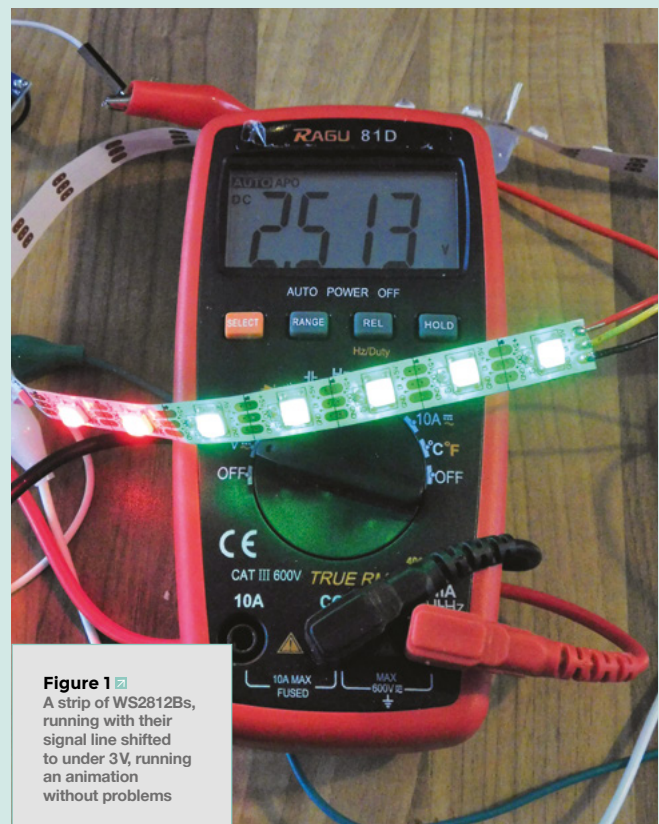

**Figure 1** A strip of WS2812Bs, running with their signal line shifted to under 3V, running an animation without problems



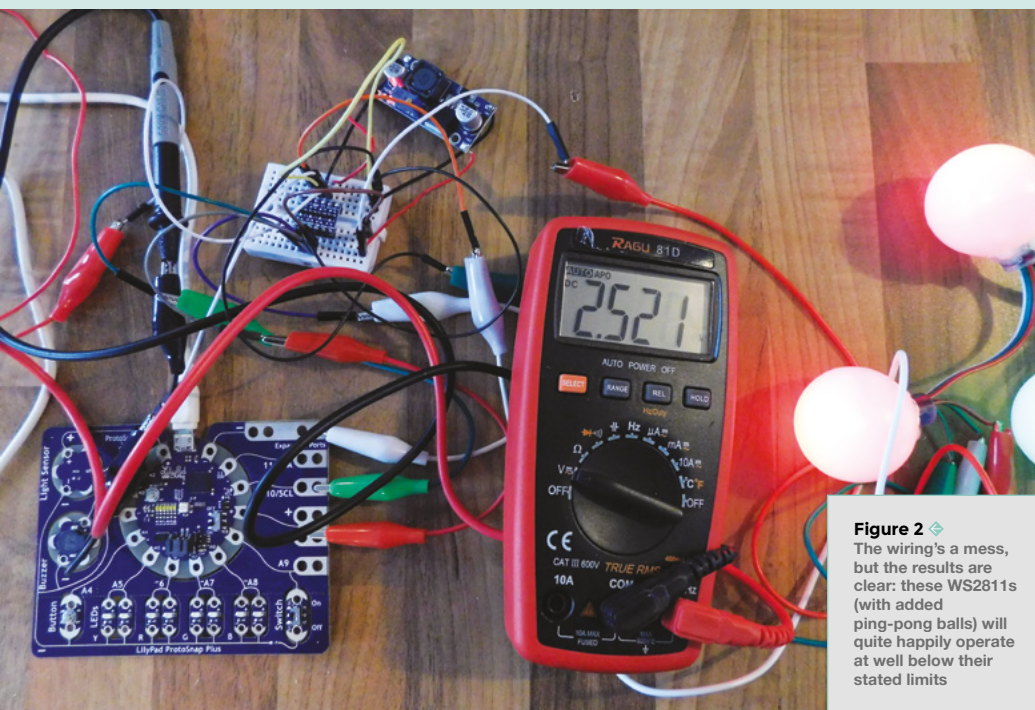

**Figure 2** ♦ The wiring's a mess, but the results are clear: these WS2811s (with added ping-pong balls) will quite happily operate at well below their stated limits

putting one of these in-line on the input (see **Figure 1**) will reduce the input voltage to 4.3V, and since  $0.7 \times 4.3 = 3.01\text{V}$ , you can then drive the strip of NeoPixels with 3.3V without exceeding the data sheet specification.

However, this does put the full power draw of all the LEDs through the diode. This isn't a problem for small runs that aren't very bright, but can be a problem for larger displays. We keep a stash of 1A diodes for just this purpose which is definitely fine for strings of 15 or fewer LEDs, and can be fine for much larger displays depending on brightness and colour. If you're drawing this level of current, you probably want to think a little about your power supply anyway as this exceeds what most microcontrollers can supply on their 5V pin.

You can sidestep this problem a little by only driving the first NeoPixel with 4.3V, and then supplying the full 5V to LEDs after this (see **Figure 2**). The first NeoPixel will output data at 4.3V to the second NeoPixel, which can then operate without problems. The two caveats to this are that wiring is a little more complex as you have to power the first NeoPixel differently, and the first will also be a little less bright than the others in the strip. □

magazine kit box). We connected the data pin to various NeoPixels through a level shifter. We then ran an animation on the NeoPixels, while gradually turning down the voltage on the level shifter to see at what point it stopped working.

We wanted to test two things – do different strips of NeoPixels from different suppliers have different voltage limits, and does it make any difference how long the strip you try to control is?

All official WS2812B LEDs come from WorldSemi, but in practice, unless you're buying from a reputable supplier, there's a very high chance that you have non-genuine LEDs. This isn't usually a problem for makers, as there's a wide range of clones that speak the same protocol and can be used interchangeably.

We tested out an array of LEDs from a range of suppliers – the results are in the table to the right. The LEDs in WS2812B batch 2 weren't randomly selected, but a batch that we suspected of having problems.

The gist of these results is that many strips will quite happily operate with a signal voltage of 3.3V (and even a bit below), but occasionally you'll come across a strip that won't. What does this mean for makers? Well, most of the time you can drive NeoPixels with 3.3V microcontrollers and still have some headroom, but occasionally, you'll come across some hardware that won't work. What does this mean for us? We'll continue to recommend that people use some way of taking this into account because we can't be sure what hardware people will be working with.

### PROBLEMS NEED SOLUTIONS

There are two basic solutions to the problem of driving NeoPixels with 3.3V microcontrollers. One is to increase the signal voltage using a level shifter; the other is to drop the input voltage. Dropping the input voltage is the simplest option for small runs of NeoPixels. A regular diode has a voltage drop of 0.7V usually, so

| Batch                          | Number of LEDs | Minimum signal voltage |
|--------------------------------|----------------|------------------------|
| Through-hole (WS2812B) batch 1 | 1              | 2.7V                   |
| Through-hole (WS2812B) batch 2 | 1              | 2.6V                   |
| WS2811                         | 1              | 2.5V                   |
| WS2811                         | 7              | 2.5V                   |
| WS2812B batch 1                | 1              | 2.5V                   |
| WS2812B batch 1                | 7              | 2.5V                   |
| WS2812B batch 1                | 30             | 2.5V                   |
| WS2812B batch 2                | 1              | 3.6V                   |
| WS2812B batch 2                | 30             | 3.6V                   |



**3 ISSUES** from £5

on a quarterly subscription



Visit: [hsmag.cc/345](https://hsmag.cc/345)



# FORGE

HACK | MAKE | BUILD | CREATE

Improve your skills, learn something new, or just have fun tinkering – we hope you enjoy these hand-picked projects

PG  
88

## RASPBERRY PI DISPLAYS

Add output to your project

PG  
92

## 3D PRINTING TIPS

Get the most out of your molten plastic

PG  
96

## DIY HEATING CONTROLLER

How to keep your shed toasty and warm

PG  
106

## AIR QUALITY MONITORING

Make sure you know what you're breathing in

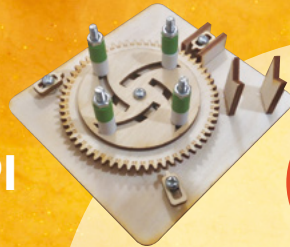

PG  
78

## SCHOOL OF MAKING

Start your journey to craftsmanship with these essential skills

78 LCDs two ways  
82 Dividing

PG  
110

## LEVEL SHIFTERS

Get your devices talking to each other across different voltages

PG  
104

## RECYCLED PLANT POTS

Learn to use Fusion 360 to make custom parts





# Add a character display to your project

Use Arduino or CircuitPython to display text



Ben Everard

[@ben\\_everard](#)

Ben loves cutting stuff, any stuff. There's no longer a shelf to store these tools on (it's now two shelves), and the door's in danger.



**D**isplays come in all shapes and sizes, and it's not about there being an overall 'best' display so much as it is picking the right one for your project. This month we're going to look at character LCDs, which are

cheap, widely available, and easy to program with most development environments.

Almost all of these are controlled by Hitachi HD44780 chips, and can take input in a couple of forms. In their bare incarnation, they have a parallel data bus which has 16 pins (though not all are needed), but there are also versions with I<sup>2</sup>C or SPI input. We'll be looking at the basic version here as these are most common, but if you need to connect a lot of displays or are short of spare microcontroller pins, you might

want to take a look at the other versions. They come in different sizes, but 16 character by two-line displays are the most common, so we'll focus on these.

Let's start by looking at how to wire up these displays. They generally all follow the same pinout, but it's always worth double-checking the data sheet of your device to make sure it's not any different. Some devices can operate at 5V, some at 3V, and some at both, so again, make sure you get the right version for the microcontroller you have. The important thing to remember is to power the device with the same voltage as the logic, so if you have a 3.3V microcontroller, make sure you power the LCD with 3.3V.

With the output pins at the top and the LCD screen facing you, the pins are from left to right:

**Above** This Adafruit display has four lines and an RGB backlight to give a more interesting display



1. Ground
2. Power
3. Contrast
4. Register Select
5. Read/Write
6. Enable
7. Data 0
8. Data 1
9. Data 2
10. Data 3
11. Data 4
12. Data 5
13. Data 6
14. Data 7
15. Backlight positive
16. Backlight negative

You don't need all of these pins. Power and ground obviously need to be connected to power and ground. Contrast takes a voltage, and the easiest way to create an adjustable voltage (and therefore giving you a way of controlling the contrast on the screen) is to create a voltage divider with a potentiometer. Connect the pin on one side of the potentiometer to power, the other side to ground, and the middle one to the contrast pin. This way, you can vary the look of the display by twiddling the knob.

Read/write should be connected to ground. You'll need six pins on your microcontroller that take register select, enable, and Data 4–7. Any digital pins should do. We used an Adafruit Grand Central and pins 21, 19, 17, 16, 15, 14 respectively, but change these out as you need.

The backlight should also be connected to power. You might need a resistor to protect this – take a look at your device's data sheet or, if you're not sure, use a 220ohm resistor just to be safe.

```

#include <LiquidCrystal.h>

LiquidCrystal lcd(21, 19, 17, 16, 15, 14);

void setup() {
  lcd.begin(16, 2);
  lcd.setCursor(0, 0);
  lcd.print("Hello");
  lcd.setCursor(0, 1);
  lcd.print("World");
}

void loop() {
  for(int i=0; i<11; i++) {
    lcd.setCursor(i, 0);
    delay(500);
  }

  for(int i=0; i<11; i++) {
    lcd.setCursor(i, 1);
    delay(500);
  }
}
  
```

```

1 import board
2 import digitalio
3 import adafruit_character_lcd.character_lcd as characterlcd
4 import time
5
6 lcd_rs = digitalio.DigitalInOut(board.D21)
7 lcd_en = digitalio.DigitalInOut(board.D19)
8 lcd_d7 = digitalio.DigitalInOut(board.D14)
9 lcd_d6 = digitalio.DigitalInOut(board.D15)
10 lcd_d5 = digitalio.DigitalInOut(board.D16)
11 lcd_d4 = digitalio.DigitalInOut(board.D17)
12
13 lcd_columns = 16
14 lcd_rows = 2
15
16
17 lcd = characterlcd.Character_LCD_Mono(lcd_rs, lcd_en, lcd_d4, lcd_d5, lcd_d6, lcd_d7, lcd_columns,
18
19 lcd.create_char(1, b'\x00\x00\x00\x04\x00\x00\x00\x00')
20 lcd.create_char(2, b'\x00\x00\x0a\x04\x0a\x00\x00\x00')
21 lcd.create_char(3, b'\x00\x11\x0a\x04\x0a\x11\x00\x00')
22 lcd.create_char(4, b'\x15\x11\x0a\x15\x0a\x11\x15\x00')
23
24 while True:
  
```

### SHOW US THE CODE

We'll start by looking at how to control this display with CircuitPython (we'll take a look at Arduino next).

The following code sets up the LCD and displays the classic first text, 'Hello world'.

```

import board
import digitalio
import adafruit_character_lcd.character_lcd as
characterlcd
import time

lcd_rs = digitalio.DigitalInOut(board.D21)
lcd_en = digitalio.DigitalInOut(board.D19)
lcd_d7 = digitalio.DigitalInOut(board.D14)
lcd_d6 = digitalio.DigitalInOut(board.D15)
lcd_d5 = digitalio.DigitalInOut(board.D16)
lcd_d4 = digitalio.DigitalInOut(board.D17)

lcd_columns = 16
lcd_rows = 2

lcd = characterlcd.Character_LCD_Mono(lcd_rs, lcd_
en, lcd_d4, lcd_d5, lcd_d6, lcd_d7, lcd_columns,
lcd_rows)

lcd.message = "Hello\nworld"

while True:
    pass
  
```

**Above** CircuitPython is now running on over 100 different boards

**Below** Adding output to your Arduino projects has never been easier

As you can see, there's not a huge amount we need to get everything working. We just need to create `Character_LCD_Mono` object using the connections we've used. Once we've got this, we can set the message property to the message we want to display. As you can see, the message contains the `\n` newline character, which makes our test display on two lines.

Using it like this, we can easily send whatever text we want to the little screen, and it will be displayed for all the world to see. However, we don't need to stop here. There are even more features we can explore to make our display a little more interesting. →



## Add a character display to your project

### SCHOOL OF MAKING

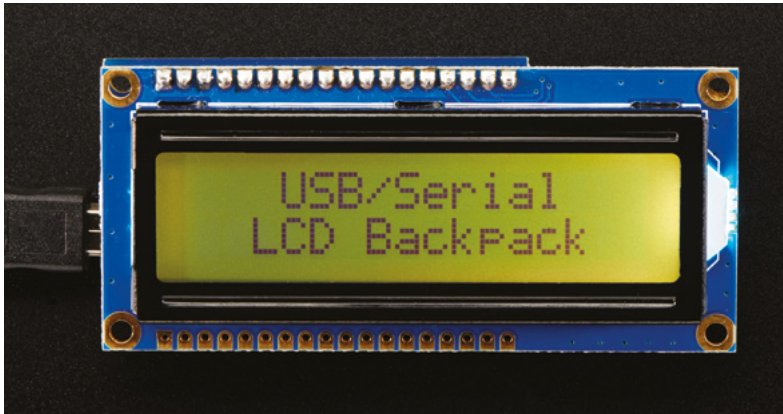

**Above**  No GPIO? No problem. You can get USB backpacks that let you drive these displays from a USB serial connection

We can replace the `while` loop above with the following:

```
while True:
    for i in range(1,11):
        lcd.move_right()
        time.sleep(0.5)
    for i in range(1,11):
        lcd.move_left()
        time.sleep(0.5)
```

This will make the text bounce across the screen using the `move_right()` and `move_left()` methods.

These displays are very much focused around displaying text. They receive text as character codes and display it using their own internal font. This means they're very easy to work with as we don't need to worry about pixels, but it does limit what we can display. To make matters a bit more flexible, they include eight slots for custom characters that you can program yourself.



We created a simple star animation by growing points out from this dot



Each character is a block of pixels five across by seven up, and you can display whatever you want in these.

You need to create a binary string to represent the string of pixels, with a 0 being the pixel off and a 1 being the pixel on. This sounds a bit complex, but there's a tool at [hsmag.cc/6zj1vD](http://hsmag.cc/6zj1vD) to help us. We're going to create a series of characters to create a mini firework animation, and the first is just a dot in the middle of the 5x7 array. We can draw this on the website, and it'll tell us the hex values for this:

```
0x0,0x0,0x0,0x4,0x0,0x0,0x0
```

In CircuitPython, we format this slightly differently and we create this character with the following:

```
lcd.create_char(1, b'\x00\x00\x00\x04\x00\x00\x00\x00')
```

We created a simple star animation by growing points out from this dot and cycling through four characters. In order to display the characters, you need to show the Unicode character 0000 to 0007 corresponding to the character you've created. As most keyboards don't have an easy way of typing these, we can create them with the `'\u'` syntax.

The code for this star animation is as follows:

```
lcd.create_char(1, b'\x00\x00\x00\x04\x00\x00\x00\x00')
lcd.create_char(2, b'\x00\x00\x0a\x04\x0a\x00\x00\x00')
lcd.create_char(3, b'\x00\x11\x0a\x04\x0a\x11\x00\x00')
lcd.create_char(4, b'\x15\x11\x0a\x15\x0a\x11\x15\x00')
```

```
while True:
    lcd.message = '\u0001'
    time.sleep(0.5)
    lcd.message = '\u0002'
    time.sleep(0.5)
    lcd.message = '\u0003'
    time.sleep(0.5)
    lcd.message = '\u0004'
    time.sleep(0.5)
```

### (NOT) LOST IN TRANSLATION

The process for using these displays is roughly similar regardless of the language you use, but the syntax will be a bit different. Let's now take a look at how to get them up and running in Arduino. There's a library called `LiquidCrystal` that should come bundled with the Arduino installed – if you don't have it, you should find it in the library manager.

Let's look at the same bouncing text example that we created in CircuitPython (running on the same hardware):

```
#include <LiquidCrystal.h>

LiquidCrystal lcd(21, 19, 17, 16, 15, 14);

void setup() {
    lcd.begin(16, 2);
    lcd.setCursor(0, 0);
    lcd.print("hello");
```



```

lcd.setCursor(0, 1);
lcd.print("world");
}

void loop() {
  for(int i=0; i<11; i++) {
    lcd.scrollDisplayRight();
    delay(500);
  }

  for(int i=0; i<11; i++) {
    lcd.scrollDisplayLeft();
    delay(500);
  }
}

```

We used a slightly different mechanism for displaying the text on two lines. We created each line separately, and used the `setCursor()` method to put it in the correct position.

Let's now take a look at how to create custom characters. We can use **byte** arrays here. 0s represent pixels that are off and 1s represent pixels that are on.

We've also taken a slightly different approach to writing out the characters (because this is slightly simpler in Arduino). Instead of overwriting the whole message each time, we pop the cursor in the same place and write out a single byte with the new character. The shortened code for Arduino is:

```

#include <LiquidCrystal.h>
LiquidCrystal lcd(21, 19, 17, 16, 15, 14);

byte star_1[8] = {
  B00000,
  B00000,
  B00000,
  B00100,
  B00000,
  B00000,
  B00000,
  B00000,
};
...
byte star_4[8] = {
  B10101,
  B10001,
  B01010,
  B10101,
  B01010,
  B10001,
  B10101,
};

void setup() {
  lcd.begin(16, 2);
  lcd.createChar(0, star_1);
  lcd.createChar(1, star_2);
  lcd.createChar(2, star_3);
  lcd.createChar(3, star_4);
}

void loop() {
  lcd.setCursor(0,0);
  lcd.write(byte(0));
  delay(500);
  lcd.setCursor(0,0);
  lcd.write(byte(1));
  delay(500);
  lcd.setCursor(0,0);
  lcd.write(byte(2));
  delay(500);
  lcd.setCursor(0,0);
  lcd.write(byte(3));
  delay(500);
}

```

Hopefully, we have given you enough knowledge to include LCDs in your builds. They are the simplest, easiest, and cheapest way of getting extra bits of text in your projects. They can be a simple add-on to output useful diagnostics (especially for untethered projects that can't use USB serial) or critical parts of the interface.

Make sure you have got one or two spares in your kit box and you might find that your projects go a little smoother. □

**Left** ♦  
We found that we wanted full contrast, so just connected the contrast pin to ground

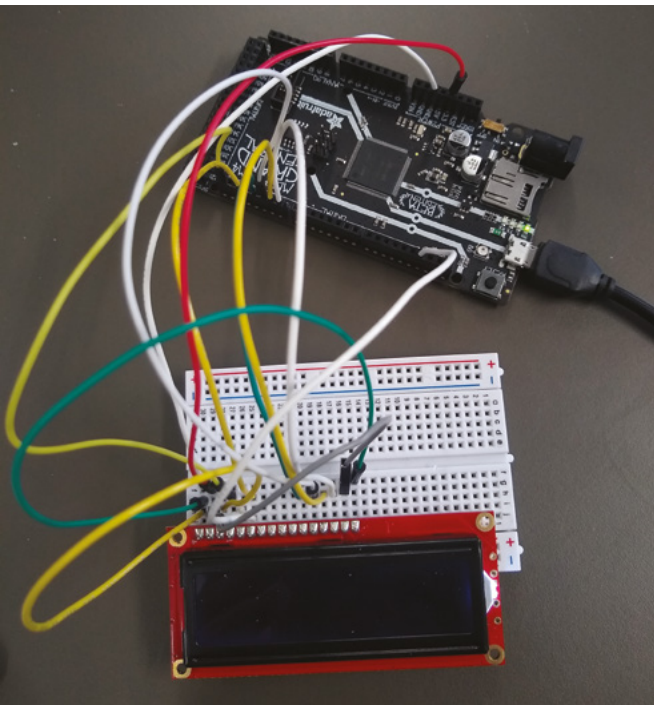



# Dividing and indexing hackspace-style

Tools for dividing and indexing can be costly – let's look at some hackspace-type approaches to this common process



Jo Hinchliffe

[@concreted0g](#)

Jo Hinchliffe is a constant tinkerer and is passionate about all things DIY space. He loves designing and scratch-building both model and high-power rockets, and releases the designs and components as open source. He also has a shed full of lathes and milling machines and CNC kit!

**Figure 1**

A laser-cut tool we made to help mark equidistant points around the circumference of different sized tubes

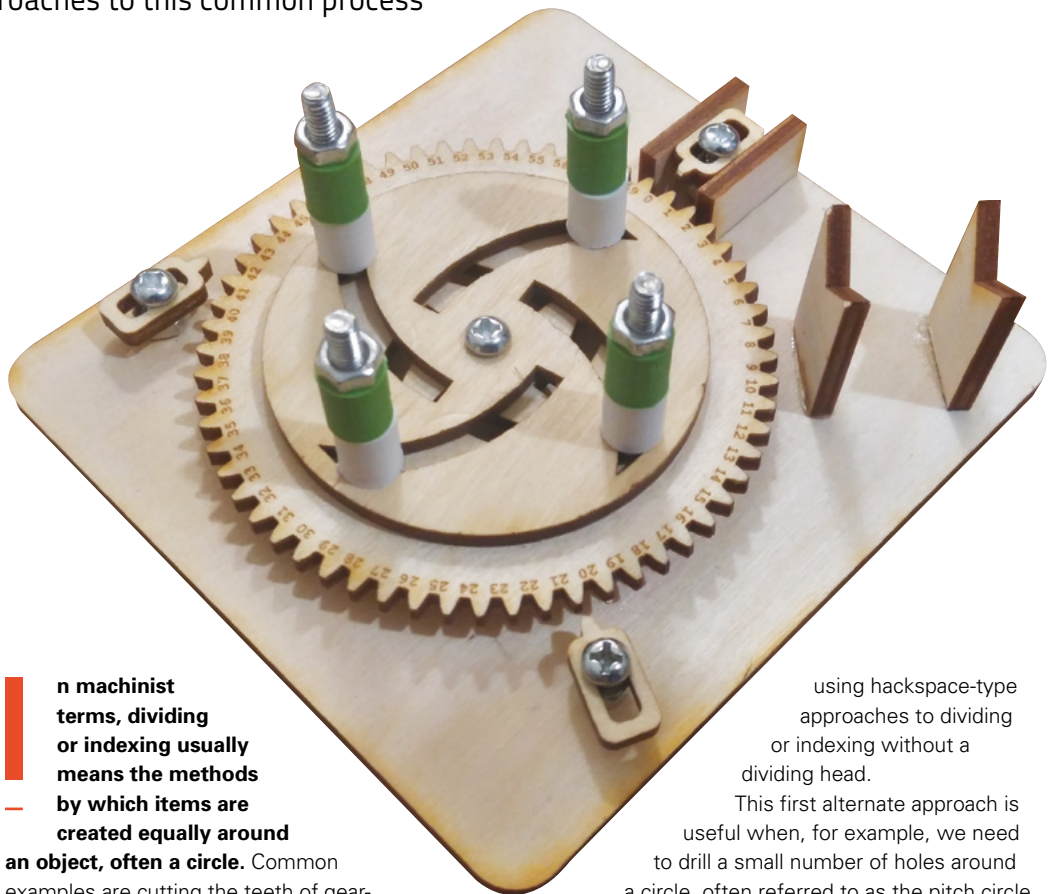

**In machinist terms, dividing or indexing usually means the methods by which items are created equally around**

**an object, often a circle.** Common examples are cutting the teeth of gear-wheels, but it also can refer to drilling a number of holes around a circular path, like a cylinder head, or milling repeating flat sections to form a geometric shape, such as a hexagonal bolt head.

There are numerous approaches and numerous tools that can be used to help with dividing, the most common one in a professional machine shop being a dividing or indexing head. These are expensive pieces of equipment for home users to purchase, and are often too large to fit on smaller machines. In this article, we are going to look at alternatives –

using hackspace-type approaches to dividing or indexing without a dividing head.

This first alternate approach is useful when, for example, we need to drill a small number of holes around a circle, often referred to as the pitch circle diameter, or PCD. Some relatively simple maths can be used to generate the X and Y axis co-ordinates needed to drill these holes, and we can mark out those positions on a workpiece, or we can use the dials on a milling machine to move to these positions and drill. We need to know how many holes we require spaced around the circle, and we need to know the radius of the circle. We then use two similar equations to work out the X and the Y co-ordinates of each hole location, relative to the centre of the circle.



## A COMMERCIAL SOLUTION



Dividing heads are the professional tool used in machine shops to perform dividing and indexing operations. They are an assembly that can rotate a piece of work and use dividing plates, which are metal plates with lots of circles of holes accurately created. These plates allow the work to be indexed through very precise angles. The workpiece is rotated, and the division is secured by a locking pin being inserted into the correct hole on the dividing plate. The dividing plates are swappable, and plates can be created to allow dividing heads to create virtually any number of desired divisions.

For the X and Y co-ordinates, we use the formula seen in **Figure 2**, where 'R' is the radius of the circle, 'H' is the hole number, and 'N' is the total number of holes. It can be quite tricky if you are out of practice to put this into a calculator or a spreadsheet, so it's worth double-checking that you get the right result for the first hole. The X co-ordinate of 'H1' should be the same figure as the radius of the circle, and the Y co-ordinate should be zero. Using the formula will only return positive values, so it's important to note that some of the answers are going to actually be negative co-ordinates when you use them in the

the milling table and the collar, and then milled the small keyways into the bar stock, repeatedly indexing the part by resetting the piece to the next face of the octagonal collar.

### GETTING IN A SPIN

Another workshop item that is a midpoint tool (and not as costly as a dividing head) is a rotary table. A rotary table is a milling accessory that is primarily designed for machining arc paths on the manual milling machine. However, as it can rotate a workpiece through a known number of degrees, it can also be →

It can be useful to roughly draw the hole locations as you work them out

real world. It can be useful to roughly draw the hole locations as you work them out so that you can tell when co-ordinates are going to flip to being negative. Continuing and solving all the X and Y co-ordinates gives all the information needed to create a circle of holes.

While a spin indexer might give us more flexibility, for creating simple divisions, a 3D printer can be extremely useful to make an object we can use as the reference for indexing. In **Figure 3**, we have used a 3D-printed octagonal part to create a collar for some 12mm brass bar stock. We quickly designed and printed the octagonal collar with the inner diameter being a press fit onto the brass bar stock. Using the faces of the printed octagon, we can rotate the circular bar eight times and perform an operation on each face. In this instance, we have used a precision vice to clamp the workpiece. We set the position with the 3D-printed collar using a small riser block between

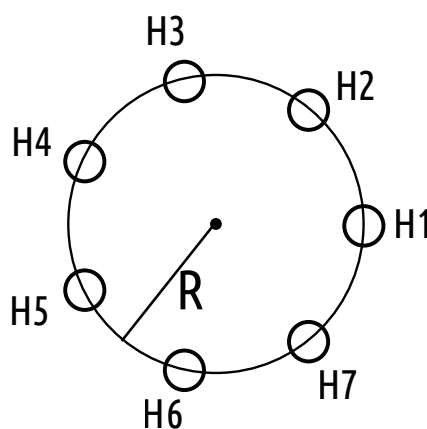

$$X = R \cos \frac{(H-1) \times 360}{N}$$

$$Y = R \sin \frac{(H-1) \times 360}{N}$$

**Figure 2** Using these equations, we can work out the X and Y co-ordinates of the centre of any number of holes around a circular path





There are some tools that sit in the midpoint between no tools and a dividing head for the workshop that can be useful on the milling machine to create divisions. The spin indexer is a relatively cheap tool, and we picked up our example for around £60. A spin indexer is a device which can clamp a workpiece in a collet, and the collet can be rotated by a known amount. The modern spin indexer has a graduated dial with the numbers 0–36 each representing 10 degrees of a circle. On the body of the spin indexer are ten holes labelled from 0 to 9, into which a pin can be located. Rotating the collet spindle and aligning a number to the arrow gives us the crude position to the nearest ten degrees, and then we place the pin in the hole for the single digit and move the spindle until the pin engages. This means we can accurately position the spindle to a single degree, making it possible to index a piece through any combination of divisions of 360 degrees. In the images, you can see that we have created a hexagonal workpiece by indexing some round brass bar stock through 60 degree steps, and milling a flat section in each position.

used for dividing purposes. It consists of a circular worktable which is rotated by a gear and worm-gear arrangement attached to a winding handle. It's a common project for machinists to convert rotary tables into forms of dividing head by adding dividing plates but, even in its standard form, the rotary table can be useful for dividing. In **Figure 4**, we can see that we have used the rotary table and a vice to create a circle of 15 equidistantly placed holes around a pitch diameter. Simply dialling the table around 24 degrees per index using the graduated dial moves the workpiece to the next position, and a grub-screw on the table acts as a lock to clamp the table while performing the drilling operations.

Using the lathe to divide can be of use, and one job we wanted to create was a dial handle with graduated markings every 36 degrees (so ten marks in a full rotation) – **Figure 5**. This dial will eventually be part of an assembly that moves the spindle forwards and backwards at a rate of 1 mm per complete revolution. So, marking it with ten marks means each mark equates to 0.1 of a mm movement. We had heard anecdotes of people using a magnetic digital protractor tool to rotate the chuck by a known amount. The digital protractors are available for less than £15 online, and have a magnetic base so can be attached to ferrous objects. They can be set into a mode where they can be zeroed, and therefore we can repeatedly use them to rotate objects by a known amount. To create this crude but effective marked dial handle, we placed the workpiece in the lathe chuck with the lathe unplugged, and locked the spindle in place. We then used a sharp tool in the tool holder to mark a line into the workpiece by pushing it into the

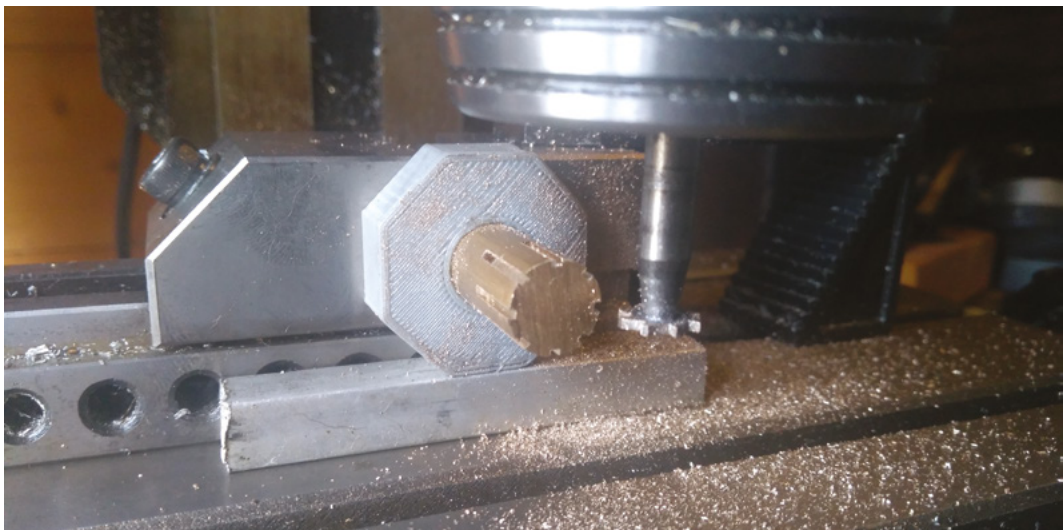

**Figure 3** ♦ Using a 3D-printed press fit collar on a piece of brass bar to perform eight equidistant milling operations around its circumference



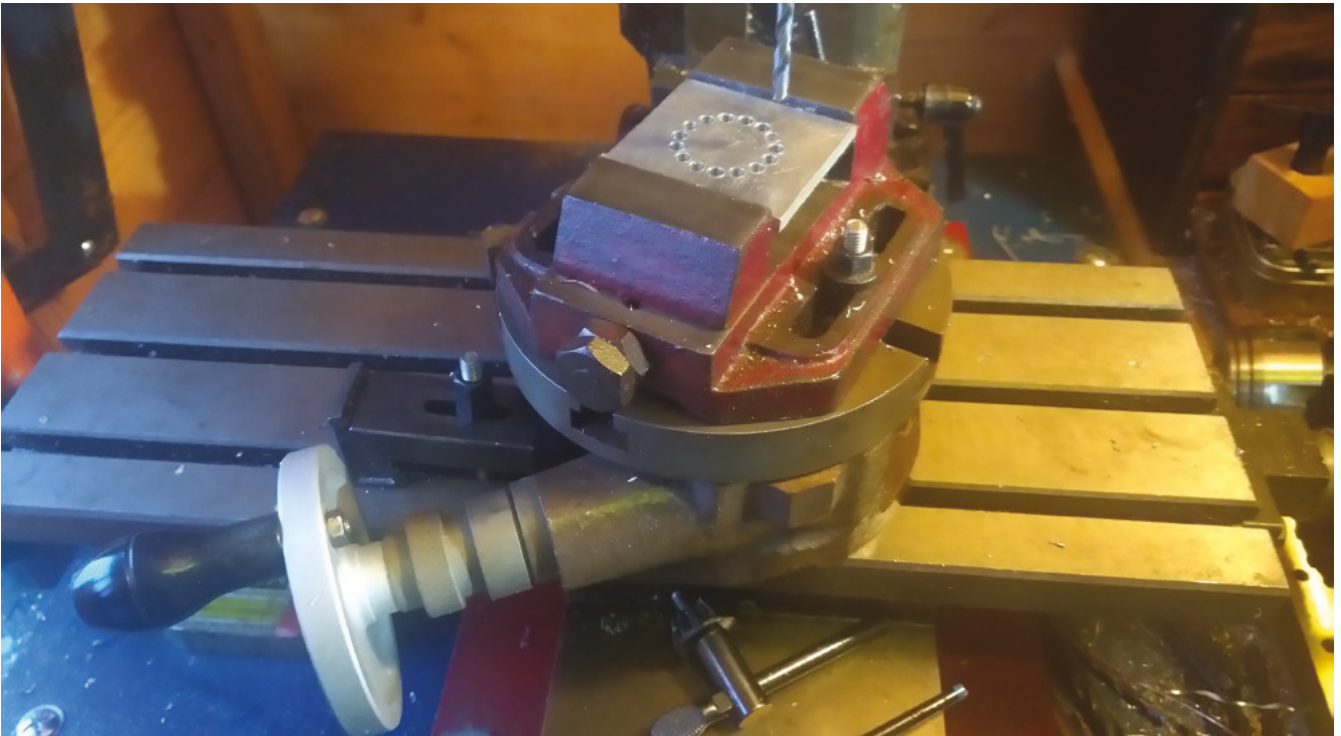

piece slightly and then moving the carriage back out from the workpiece to scribe a line. We then placed the digital protractor on a jaw of the chuck, unlocked the spindle, and hand-rotated the workpiece 36 degrees, locked the spindle, and repeated the process until we had marked all ten lines (**Figure 6**). While we had some doubts about how well this would work, and we definitely could increase the quality of the mark by grinding a purpose-made tool, we were very surprised at how accurate this method was.

### GETTING CREATIVE

With imagination, hackspace-type tools like laser cutters, 3D printers, and CNC machines can be used to create all kinds of tools that can help with dividing tasks. Printing or cutting dividing plates that can be attached to spindles can enable us to create dividing heads, and we have seen many examples of 3D-printed gears being used to index workpieces. Taking things a little further, we created a tool that helps us mark divisions around tubular workpieces, which is a common task for those involved in the building of model rockets who want to accurately place fins around a tube. We based this tool around a type of self-centring chuck called a Longworth chuck which consists of two plates which, when counter-rotated, can move four 'jaws' inwards and outwards. This assembly allows a tube to be held in position with the jaws either inside or outside of the tube, (**Figure 1**). Instead of making the bottom plate of the chuck assembly circular, we used Inkscape's

'gear generator' plug-in to create a gear with 60 teeth. We then numbered each gear tooth valley from 0 to 60, to allow us to rotate the assembly by a known amount. We added a base, and created some sliding gear locks which simply engage with the gear and can lock it in place. The rest of the assembly of this tool consists of a simple pair of stand-offs with a V-shape cut into the top of them, which allows a pen or pencil to be slid into position and mark a dot onto the held tube **Figure 7**. →

**Figure 4** ♦ A rotary table can be used to index workpieces in various ways – in this instance to drill a circle of equidistant holes

### LASERS!



If you have access to a laser cutter, you can easily create patterns that can assist in drilling holes around a diameter. Often, software graphics packages have ways of automatically cloning a circle 'hole' object around a circular path, or if not, using the x-y co-ordinate calculation methods elsewhere in this article should enable you to draw the required pattern. Laser-cut patterns cut in plywood or plastics can then be used to either mark out on the real workpiece, or even can be clamped to a workpiece and used as a drill guide. In the image, we have used the Inkscape drawing software to draw and cut a series of seven 4mm holes around a 30mm pitch diameter that could be used as a drill guide.



# Dividing and indexing hackspace-style

## TUTORIAL

**Figure 5** ♦

A simple but effective dial handle that, when finished, will move a threaded spindle 0.1 mm per engraved mark



**Figure 6** ♣

Cheaply available digital protractors are incredibly accurate, and can allow workpieces to be rotated by known amounts

## Makerversity: Summer 2020



Vector Space in Central Virginia is hosting the nation's most immersive and exciting maker camps this summer. Our overnight camps feature a broad range of tools and projects, with an in-depth examination of materials, the use of exciting new technologies, and some of human kind's oldest fabrication techniques. Each camp is taught by leading maker educators recruited from around the country. Rising college freshmen can enroll online today.



**Three Sessions: July 12 - August 1**  
Enroll at [vector-space.org/makerversity](http://vector-space.org/makerversity)

Any number of marks that's a factor of 60 can be made by starting with the gear set to zero at the reference gear lock, and marking the first point and then indexing the assembly around to the desired division. So, for the example of a rocket tube with 4 fins, indexing and marking through the numbers 0, 15, 30, and 45 gives the correct points. Having marked the tube, we can remove it and extend the marks using a piece of aluminium angle to ensure the lines remain straight in relation to the centre point of the tube. While this application is a pretty unusual use case, we hope that it perhaps inspires ideas into how laser-cut or 3D-printed tools can be made that assist dividing tasks in projects. All the files for this particular tool are available here: [hsmag.cc/UXcwxP](http://hsmag.cc/UXcwxP).

If you have your own hackspace-style methods and approaches to dividing and indexing, share them with us here: [twitter.com/HackSpaceMag](https://twitter.com/HackSpaceMag). □

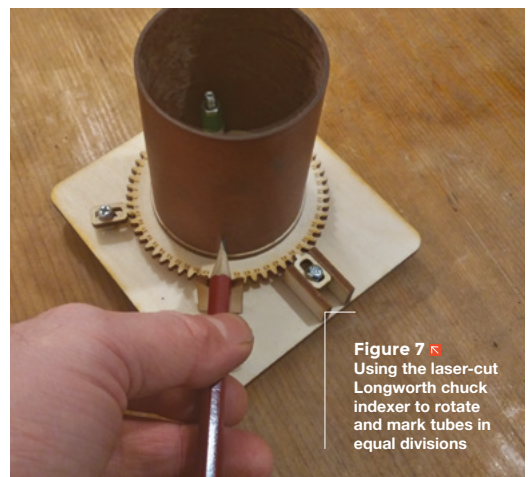

**Figure 7** ♣  
Using the laser-cut Longworth chuck indexer to rotate and mark tubes in equal divisions



# Wireframe

Join us as we lift the lid  
on video games



Visit [wfmag.cc](http://wfmag.cc) to learn more



# Raspberry Pi displays

Add dynamic colourful displays or sleek infographics to your project



PJ Evans

@mrpjevens

PJ Evans is a developer and wrangler of the Milton Keynes Raspberry Jam. He runs a LoRa gateway, which is probably the nearest he'll get to his own radio breakfast show.

**M**

**any projects produce data.** It seems like a simple enough thing to say, but often that data goes 'uncharted'. Other projects, especially mobile makes such as robots, could have their

movement visualised in an engaging way, but often microcontrollers lack the power to produce a suitable display. Adding a Raspberry Pi computer to

your build opens up a world of display types that can add a new dimension to your make, whether it's a simple readout, pretty chart, or even a hypnotic pattern. In these pages, we've picked a few of our favourite examples.





# 7-segment LED display

ADAFRUIT ♦ £9 | thepihut.com

Let's start with one of the most basic types of display: LEDs. Light-emitting diodes have been a stalwart of the maker community since their invention, and they will feature heavily in this article. The classic seven-segment LED display became popular in 1970s alarm clocks, thanks to its bright display and the futuristic wizardry of a fully electronic system. It's probably because of the millions of alarm clocks built since then that this classic four-digit display is so common.

Using I<sup>2</sup>C, you can always chain multiple displays together

As is often the case with LED displays, they require a lot of pins to work. Unless, that is, you have a dedicated driver chip such as the MAX7219. Using a technique called multiplexing, the entire display can now be driven using Raspberry Pi's I<sup>2</sup>C interface. This build from Adafruit contains the display and the driver chip on a single board, although a small bit of soldering is required. As ever, Adafruit backs this up with a Python library to make controlling the display in code as easy as possible. If your project is time-based, or requires a numerical output, this is a cheap and effective solution. Got a long number to display? Using I<sup>2</sup>C, you can always chain multiple displays together.

**Below** ♦ Great for retro projects, and simple and easy-to-read information displays

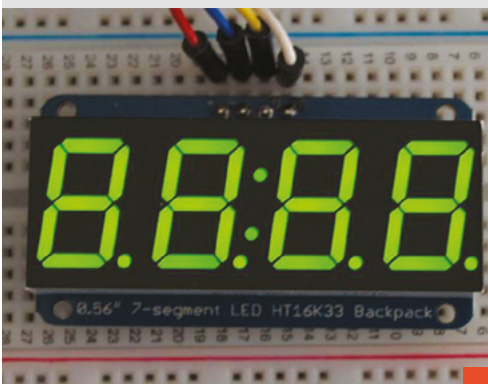

# Adafruit 16x2 LED display with keypad

ADAFRUIT ♦ £18.50 | thepihut.com

A seven-segment LED display is all very well for numbers, but it's not so great at text. You can make approximations and even add scrolling effects, but there are better alternatives. The next step up is this LCD that can produce 32 characters on two lines of 16. It's a common display type, originally designed for providing simple interfaces for machinery. There is a nice retro feel to this display, but it can have real purpose if you need something bright.

Again, this is an Adafruit kit and provides everything you need in a single package. The 16x2 panel itself is widely available and very cheap but, just like its smaller cousin, it requires many GPIO pins to work. This kit features a GPIO input expander and five tactile switches to create a small control unit that only requires a few pins. Available in a range of colours, it's perfect for bright text readout and small projects, such as media players.



**Above** ♦ Perfect for high-visibility text readouts

# PaPiRus eInk display

PI SUPPLY ♦ £40.99 | uk.pi-supply.com

One thing that displays of all types tend to have in common is their relatively high power requirements. If you have a project that is battery-powered and only requires occasional updates, then an e-ink screen is worth consideration. This technology comprises thousands of pigmented balls 'floating' in a panel. By applying positive or negative charge, the balls are either pulled up or down. When up, their pigment can be seen; when down, they're covered. Their unique feature is that they remain in place permanently. Power is only consumed when the screen is refreshed. This makes e-ink perfect for low-power projects. The cons are a very slow refresh rate (you can forget about anything animated), and you are typically restricted to monochrome, although two-colour screens are available.

The PaPiRus range from Pi Supply offers a very simple and effective way to add an e-ink screen to your project. These come in a range of sizes and all connect to Raspberry Pi GPIO as HATs. Installation is just connecting the display and installing some software.

**Below** ♦ E-ink displays are slow to refresh, but retain their display without power

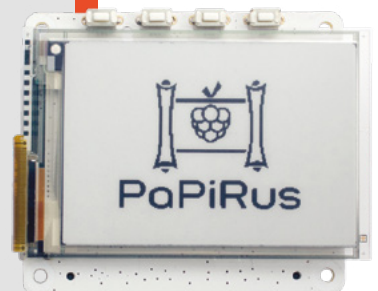



# Official Raspberry Pi 7" Touchscreen

**Right**  This official screen combines a beautiful compact display with touch capability

RASPBERRY PI  £60 | [pimoroni.com](http://pimoroni.com)

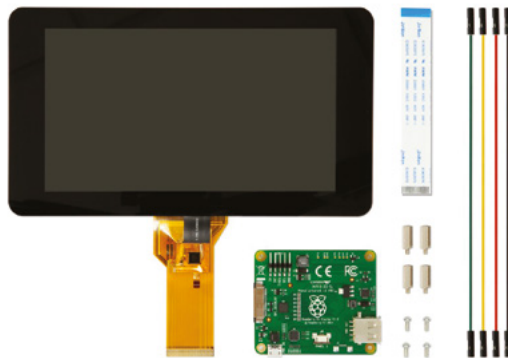

Moving on to more common displays, we come to Raspberry Pi's very own 7" touchscreen. It's been around for a few years and has become a firm favourite in the community as a reliable, high-quality product. The touchscreen is a monitor capable of an 800x480 pixel display. Two things separate this display from the others featured here. First, it uses the DSI interface found on all Raspberry Pi models, so no GPIO sacrifice bar some for power and a couple of GPIO pins for the other unique feature. This, as you've probably guessed from the name, is a touchscreen, which makes it perfect for interactive applications. By default, it acts as a mouse pointer, so installation is literally connecting the screen and booting as Raspbian has full support built-in.

Being an 'official' product, there are a lot of third-party accessories available, including cases and stands in a range of sizes and colours. The touchscreen makes this display perfect for control panels, bright colourful infographics, and even more advanced applications like kiosks or booking systems.

## DISPLAY TYPES

### LED

The most basic type, LEDs are arranged either in a matrix or into seven-segment characters.

### TFT

Thin-film-transistor liquid-crystal displays are the most common for older and lower-cost monitors.

### IPS

In-plane switching renders a very high-quality display with a much wider viewing angle than TFT.

### OLED

A modern display technology that gives sharp displays with better contrast than IPS. Can be expensive with a shorter life-span than other options, so tends to be available in smaller sizes.

## PiOLED

ADAFRUIT  £14 | [pimoroni.com](http://pimoroni.com)

If clarity is an important feature, and you don't mind a smaller display, OLED (Organic LED) is becoming more affordable. This technology offers superior colour reproduction and much higher contrast than other display systems. OLED is starting to make its way into mobile phones and some televisions, but it remains expensive. However, small monochrome OLED screens can now be added to Raspberry Pi models starting at just £15. These are ideal if you want a razor-sharp but very small screen to display more complex information.

There are many OLED HATs on the market, some even featuring full colour, but they typically only go up to about 7" in size. The Adafruit PiOLED featured here is a tiny 128x32 display that slips over six GPIO pins to use I<sup>2</sup>C for the display, leaving lots of pins to play with. The provided Python library makes it easy to display data or create animations (it has a refresh rate of 30 fps). The OLEDs used will start to dim after about 1000 hours of use, so make use of screen blanking!

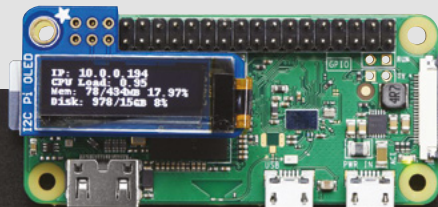



## HDMI 10" Screen

PIMORONI  £95.10 | [pimoroni.com](http://pimoroni.com)

It may seem a bit obvious to mention HDMI here, but it is, after all, the de facto standard for Raspberry Pi displays, at least on desktops. HDMI comes in a range of resolutions. It's most famous for high-definition screens, but you can also get smaller ones. Also of use is its ability to carry 5.1 audio as well, something nothing else here can do. HDMI is directly compatible with the older DVI-D standard, which means that an older monitor can often be picked up cheaply. You just need a £1 adapter.

Possibly of most interest to makers are the 'guts' HDMI kits available. This 10" panel is sold by Pimoroni and is used in the firm's famous Picade kit. If you're building an arcade console, kiosk, or another type of information display, this is a great and simple way to get up and running.

**Right**  HDMI offers the widest selection and larger sizes, but at a price

**Left**  OLED offers crisp images in a variety of sizes, but can get expensive





# Unicorn HAT HD

PIMORONI ◆ £33.90 | pimoroni.com

If you're feeling a bit more creative, or want to visualise your data in an unusual way, the wide range of LED matrix boards may be more fun. These are simple grids of individually addressable LEDs, along with driver circuitry to make them easy to code. After that, it's up to you. Create dynamic rainbow patterns, or combine with a gyroscope or accelerometer to create interactive art. The best thing about these displays is the incredible range of shapes and sizes available: from tiny Pimoroni

“ These are simple grids of **individually addressable LEDs** ”

Scroll pHATs for Raspberry Pi Zero, to the huge Unicorn which features just 256 bright LEDs, but is 19 cm x 19 cm in size and can be chained together to create a truly massive display. There are even flexible displays available so wearables can join in the fun.

This Unicorn HAT is a fun way to show data that fits snugly on a standard Raspberry Pi B form factor. Using the provided Python libraries, you can unleash your artful side to create animations or find new ways to represent data from sensors. Perfect for sound-to-light projects. If your project needs text, think carefully. Rudimentary scrolling text is possible but only really suitable if you're going for that aesthetic.



# Pi Projector

MICK HELLSTROM ◆ approx £110 | mickmake.com

How about some movie magic? Can you project from a Raspberry Pi? Why yes, you can. In fact, this kit produces a much more high-quality display than the common 'nano projectors' that are now widely available. Pi Projector came about when maker Mick Hellstrom happened across an evaluation projector unit produced by Texas Instruments. The DLP2000 is a small board featuring a low-resolution DLP projector, the kind of projection system used in digital cinemas

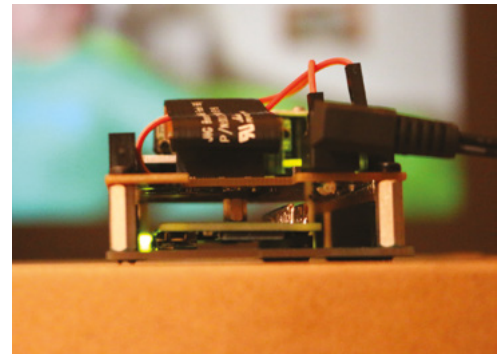

and higher-end home projectors. It was intended for use with a BeagleBone Black as a design reference – but, one small piece of PCB design later, Hellstrom managed to get it working with a Raspberry Pi Zero.

A DLP2000 will cost you around £90 from a specialist electronics retailer. You'll need to add your own Raspberry Pi Zero and purchase the Pi Projector board from Tindie, but it'll only set you back £4. Assembly is tricky due to space restrictions, but the resulting image is surprisingly good, even in daylight, as DLP produces a much better contrast range than LCD. If assembly isn't for you, try an LCD-based nano projector instead. Either way, if projection would enhance your project, this is a great way to do it. □

**Above** ◆ Big screen fun from a Raspberry Pi Zero? Oh yes

**Below** ▣ LED matrices come in all shapes and sizes, and can be used to produce beautiful effects

## KNOW YOUR CONNECTORS

There's more than one way of connecting a display to a Raspberry Pi computer:

### HDMI

The most common method, producing a display of up to 1920×1080 pixels.

### DSI

Based on an industry-standard interface often found inside monitors and TVs, this ribbon connector is used by the official touchscreen.

### Composite

All Raspberry Pi models are capable of producing a low-resolution standard composite signal, although you may have to tweak settings for it to work.

### GPIO

Many displays, especially those with lower resolutions, use the GPIO as an interface.



# Amazing 3D Printing Tips and Tricks

A collection of pro tips to get the most from your 3D printing experience



Gareth Branwyn

@garethb2

Gareth has been a lifelong practitioner (and chronicler) of DIY tech, media, and culture. He is the author of ten books, including *Tips and Tales from the Workshop*, and is a former editor for *Boing Boing*, *Wired*, and *Make*.



## GENERAL TIPS AND ADVICE

**Keep it clean** The oil from your hands and airborne contaminants can prevent your prints from sticking to the build platform. Keep your build platform clean with some isopropyl alcohol.

**Use maple syrup for what, now?** People use all sorts of weird stuff to improve bed adhesive for ABS plastic prints. Some people use special papers, glues, sprays, and tapes, as well as glue sticks, hair-spray, and painter's tape. But the weirdest of all has got to be maple syrup. Some printers swear by it.

**Don't be tempted to buy a super-cheap printer** Do your homework and take negative feedback that you hear about a printer seriously. Manage your expectations about what an inexpensive printer can actually do. As in most things, you get what you pay for.

**T**he consumer 3D printing industry has had its up and downs since its birth a decade ago, but few people can now deny its continued growth, maturation, and increasing utility.

From early adopter, assemble-your-own machines, and Yoda-bust test prints to serious applications across all realms of making, small-scale manufacturing, research and development, 3D printing becomes more widespread and indispensable by the day.

To get the most out of your 3D printing experience, we've gathered together this collection of tips, tricks, and little-known printing techniques from some of HackSpace magazine's 3D printing contributors.

**Above** Bass inserts can be pressed into 3D prints to hold bolts



**Don't be tempted by cheap filament** Cheap filament means air pockets, out of round material, inconsistent diameters, and is nothing but trouble since the printer has no idea how much filament is actually extruded. Do yourself a favour and buy from a name brand company.

**Using a mirror as your print bed** Mirrors make the best bed platforms on cheaper machines since mirrors need to be manufactured perfectly flat to reflect properly. Even on printers that use glass beds, the bed can sometimes be cast more unevenly than they look.

**Level-bedded** Before running a print on a new machine, stand a steel ruler on its edge and run it back to front along the print bed, looking for light gaps where the ruler meets the bed. Wherever you find them, use tape or foil to help even out the bed. Repeat for x-axis/left-to-right.

**Using brass inserts** It's a good idea to use threaded brass inserts for parts that will be screwed and unscrewed repeatedly. You can sink these inserts into your print using a soldering iron to heat and melt them into the plastic. You can use a regular, suitably sized soldering tip, but there are also commercial tips designed for this specific task. You can also use an old drill press stand and soldering iron to make a heated press tool for brass inserts if you need to embed a lot of them.

“  
But the weirdest  
of all has got to be maple  
syrup. Some printers  
swear by it  
”

**Using waste filament as filler** Waste prints and raft/support material are useful as filler when welding parts together with a hot-air gun or soldering iron. You can also fill/repair prints using 'friction welding'. Chuck a piece of filament into a rotary (Dremel) tool and let the spinning material melt into cracks as needed.

**Don't forget extrusion width** In a CNC Kitchen video on YouTube ([hsmag.cc/iHJdPr](https://hsmag.cc/iHJdPr)), Stefan looks at extrusion width, something that most 3D printers tend to overlook. Extrusion width defines how wide the lines of extruded material will be. Wider lines require more pressure to squeeze the molten filament out of the nozzle and to press the layers together. Stefan discovered that increasing the width can produce



stronger prints in a shorter amount of time. In the comments to the video, a viewer named Mikolas Zuza shared another reason for considering extrusion width: “There is another reason to adjust the extrusion width. If you look at the perimeters value in PrusaSlicer, there's a tooltip suggesting a perfect wall thickness for a given number of perimeters. If you match this value, either by adjusting the extrusion width or editing your drawing, the perimeters will fit perfectly without any need for a gap fill. This can help achieve nearly perfect wall-surface finish, as there is minimal material overflow.” →

**Above** ♦  
Some feet in the  
corners of your prints  
help keep everything  
stuck down

**Credit**  
Andrew Lewis

## PRINT 3D TEST PARTS FROM THE MCMASTER-CARR CATALOGUE

Maker Meredith Scheff-King discovered a wonderful feature hidden within the indispensable McMaster-Carr online catalogue ([mcmaster.com](https://mcmaster.com)).

Many parts in the catalogue have 3D models available for them. These files can be downloaded and converted into 3D printable files. Here are the basic steps:

1. On the catalogue, find the part you're interested in and look for a 'Product Detail' link.
2. On that link, next to a technical drawing of the part, you'll see a drop-down menu of 3D file types available. Select the format you want (likely STEP) and download it.
3. From here, you'll want to convert your file to STL format.
4. Once it's in STL, you can open the file in your favourite CAD program to manipulate and print as desired.

Making use of this feature, you can print an expensive/critical part in plastic first and test-fit it to make sure that it's the part you want before you buy a proper version. Meredith has a piece on Instructables ([hsmag.cc/S4WjnM](https://hsmag.cc/S4WjnM)) which shows the steps in a bit more detail.

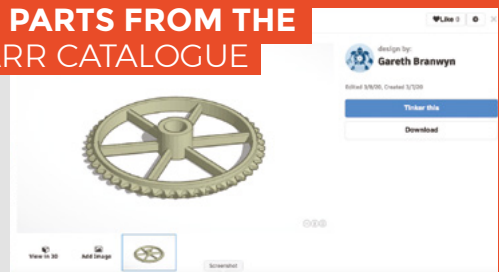



### QUICK TIP

To remove strings or unwanted support leftovers, carefully blast your print for a second with a small propane torch. Also, if you get stress marks in your print from bending, a quick blast with a heat gun will get rid of them.

### Add 'feet' to your prints to hold the corners down

To help prevent the corners of your prints from lifting, add 10mm discs the height of a single layer to the bottom corners of your models when printing without a raft. When your print is done, you can easily cut these feet away with a razor knife.

**Is your first layer all squishy?** If you find that the first print layer on your 3D printer is rough and squished-looking, you may have the extruder head too close to the print bed. On most printers, the thickness of a sheet of bond paper is the normal distance between the extruder nozzle and the bed. If you notice a skipping sound coming from the extruder mechanism, it means that too much filament is being extruded, which can also make for a squished print. To fix this, recalibrate your extruder, aiming for that paper-thickness distance.

### Use an enclosure to achieve a stable temperature

New users tend to underestimate just how sensitive fused filament-type printers are to airflow/room drafts. If your printer doesn't include an enclosure, build one (even if it's just a barrier to prevent a draft).

**Tracing photos for 3D design** If you have a physical object that you want to bring into your computer for design and printing, take a photo of the object, bring the photo into Fusion 360 (or similar), and then trace,



revolve, and extrude as needed to create your object. Armed with your phone camera, a CAD program, a 3D printer, and some time and patience, you can copy and print the world – or at least a 3D-printed facsimile of it.

**Adding patterns to your prints** If you want to add colour, pattern, or visual texture to your 3D prints, try using hydrographic film (aka water transfer film) which is a water-soluble material with images on it. To use it, you put it in a bath of water and spray with an activator. You then dip your printed object into the

“ Taking high-quality time-lapse photos of 3D prints and turning them into fluid-looking build videos ”



**Above** ■ Add designs to your T-shirts with a 3D printer

**Credit**  
3DPrinterGuides

**Right** ◆ Metallic filaments contain some actual metal

**Credit**  
Dave Mordini

bath. The print on the film is then transferred to your object. Hydrographic film is readily available online. It's a technique that takes some practice, but there are numerous tutorials online that will show you how.

**3D printing on fabric** There's all sorts of potential for 3D printing on fabric. By using netting or fabric with holes in it, you can print right into the fabric, making it part of the final print. See issue 20 of HackSpace magazine for a feature on David Shorey who is one of the pioneers of 3D printing with fabric.

**Photographing your print process** We covered this amazing technique in issue 20, the 'Top Maker Tips' issue. Scott, of the YouTube channel GreatScott!, came up with a great way of taking high-quality time-lapse photos of 3D prints and turning them into fluid-looking build videos. The photos are taken each time the print head returns to its starting position. See issue 20 for the steps, and watch the GreatScott! video ([hsmag.cc/aY4HM5](https://hsmag.cc/aY4HM5)).



**Working with metal-infused filaments** Washington DC-area artist and curator Dave Mordini shared a discovery with this author. “I took an old broken lawn ornament and put new feet on it. I then 3D-scanned it using an inexpensive consumer scanner. I decided to add pizzazz to an aluminium casting of it by using copper-infused filament when 3D printing my mould. The 3D-printed mould is packed in sand. When you pour the hot aluminium into the mould, the plastic part gets burned away, but the copper remains.”

**3D printing chain-mail** There are a number of design files on Thingiverse for 3D printing chain-mail. Spanish maker Agustin Flowalstik has a popular file on the site ([thingiverse.com/thing:3096598](https://www.thingiverse.com/thing:3096598)) which prints handsome and sturdy mail using H-shaped rings.

**3D printing T-shirts** 3D printing T-shirts might be a lot easier than you realise. It involves clamping the shirt to the print bed and printing a design in

## MAKING A FILAMENT DRY BOX

It is sad how often I see 3D printer filament at someone’s house or makerspace where rolls of PLA are left exposed to the air. PLA plastic absorbs moisture. This can cause the material to bubble in the extrusion nozzle, ruining your print or clogging the head. Becky Stern has an Instructable ([hsmag.cc/cbHlwT](https://www.instructables.com/cbHlwT/)) and video ([hsmag.cc/05ghCQ](https://www.youtube.com/watch?v=05ghCQ)) on how she turned an airtight plastic tub into a PLA filament dry box. The box holds four spools and feeds them directly to the printer through Teflon tubing and rubber O-rings.

The project is very simple. Besides acquiring the parts, most of the time will be spent 3D printing the mounting brackets for a spool rod and installing the airtight feed tubes and O-rings. The project can be done in a few hours and will ensure that your moisture-sensitive filaments will remain dry as a bone.

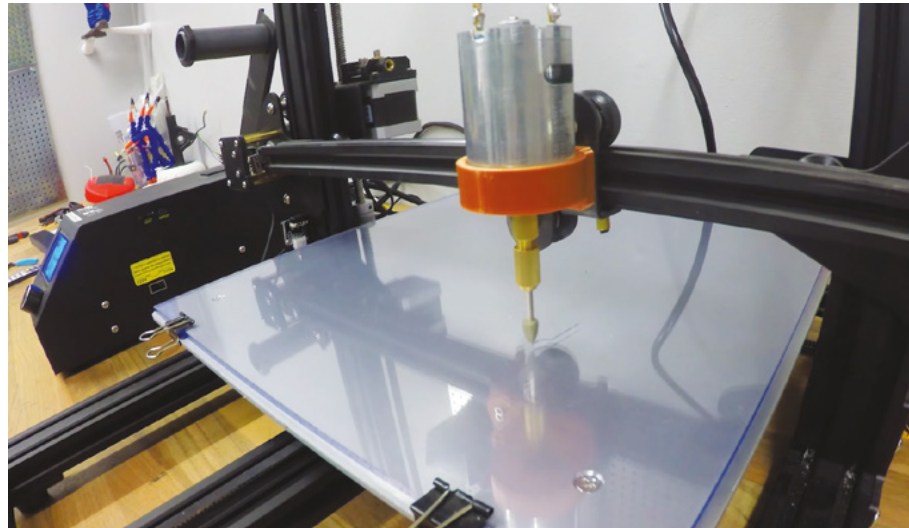

1–2 layers. Lightweight foaming PLA might even work better. In this video ([hsmag.cc/EOhjwL](https://www.hsmag.cc/EOhjwL)) on 3DPrinterGuides, Alex shows you how.

### 3D printing lithophanes and coloured lithophanes

Thomas Brooks has created an app called LithophaneMaker ([lithophanemaker.com](https://lithophanemaker.com)). He offers an intro to 3D-printed lithophanes in this video ([hsmag.cc/bKv14W](https://www.hsmag.cc/bKv14W)). In a follow-up video ([hsmag.cc/IG3IFg](https://www.hsmag.cc/IG3IFg)), he shows how he used a Mosaic Palette Pro 2 ([mosaicmfg.com](https://mosaicmfg.com)), a device for turning a conventional 3D printer into a multimaterial printer, to create multicoloured lithophanes. A lithophane is a type of three-dimensional image carved (or in this case, printed) to allow different amounts of light to shine through.

**Using Ironing and Fuzzy Skin** The 3D printer slicer app, Cura, comes with two options you may not be aware of: Ironing will smooth out and sharpen the top layer of a print; the Fuzzy Skin option creates a rough surface texture to your prints. Chuck, on the CHEP channel on YouTube, demonstrates two applications using these options ([hsmag.cc/k8GNfy](https://www.hsmag.cc/k8GNfy)).

### Casting cardboard in 3D-printed moulds

On YouTube ([hsmag.cc/3R5Me3](https://www.hsmag.cc/3R5Me3)), young maker XYZAidan shows how he created a series of moulds on his 3D printer and cast cardboard pulp in them, which he made in a blender from cut bits of cardboard rubbish. With this technique, you can shape all sorts of 3D objects out of recycled paper.

**Turning your 3D printer into a CNC engraver** In a video on RCLifeOn ([hsmag.cc/IKZv2Y](https://www.hsmag.cc/IKZv2Y)), Simon shows how he turned his 3D printer into a CNC engraver using a DC motor, a 3D-printed bracket, and some end mills. □

**Above** ♦ You can use a 3D printer for more than 3D printing

**Credit**  
RCLifeOn

**Below** ▣ Keeping filament dry is a key part of accurate printing

**Credit**  
Becky Stern

## THANKS

Marc de Vinck, Tim Tate, Becky Stern, Brian Jacoby, Chris Gilroy, Andrew Lewis, Dave Mordini, Meredith Scheff-King, Erin Winick Anthony





# WiFi heater upgrade with NodeMCU

Read multiple analogue inputs and control your electric heater over the internet



Dr Andrew Lewis

@monkeysailor

Dr Andrew Lewis is the owner of [Shedlandia.com](http://Shedlandia.com), a restorer of old tools, a fabricator for hire, a research scientist, and a founder member of the Guild of Makers.

## W

hile some heaters have built-in thermostats, they're often very inaccurate and will stick in the 'on' or 'off' position. This makes the room temperature unpredictable, and

can lead to a nasty shock when the electricity bill comes in. It can also have unfortunate side effects for 3D printers and temperature-sensitive tools. This project uses a NodeMCU and thermistor to measure ambient temperature, and control an electric heater accordingly. Using a NodeMCU for this project is cost-effective, but working with the limitations of the board can be tricky when dealing with multiple analogue inputs. The NodeMCU only has one analogue input available, and to use multiple devices, you'll need to discover how multiplexing works, and learn a few tricks about controlling relays and sensors using an ESP8266 web server.

### WINTER IS COMING

The simplest sort of heating controller is a dial fixed to a wall. Turning the dial to the left usually makes the room cooler, while turning it to the right makes

it warmer. Most people are familiar with this sort of control, and they know instinctively how to use it. It's resilient, easy to clean, doesn't need a fancy digital display, and you don't have to press multiple buttons to change any settings. Controlling this sort of dial over the internet poses a bit of a problem, because

### BE AWARE OF RISKS

This project involves connecting to and switching mains electrical voltages, and there is a risk of injury or death if you don't know what you are doing. Never work on a live electrical circuit; always make sure you use appropriate fuses, breakers, earth connections, and other safety features in your project. Make sure that there are no exposed electrical connections, and take care that there are no places where an electrical short could occur between the high and low voltage portions of the project. Alternatively, you can use a pre-built solution. There are some smart sockets that work with WiFi-enabled microcontrollers, and these allow you to avoid any mains wiring.

You also need to make sure that, in the unlikely event that the heater gets stuck on full, it's not going to start a fire before you have chance to fix it.



## MOVING BY HAND

If you've ever tried to move a live servo by hand, you'll know that even if you can get it to move, it will just spring back to its set position as soon as you let go. That isn't very useful behaviour for this project, because the user needs to be able to turn the dial by hand, and have it stay where it's put. The answer is to only power the servo when it's needed, and let it free-wheel when it's not being used. Although cutting the power to the servo using a relay or transistor might seem the most obvious way to get this behaviour, there's a much simpler solution. If you detach a servo using the `detach()` function in the `Servo.h` module, the NodeMCU will stop transmitting the position signal to the servo, and it will free-wheel. Obviously, this only works with servos that use conventional gearing – high torque servos and servos that use a worm gear will be difficult, or impossible, to move when they are powered off.

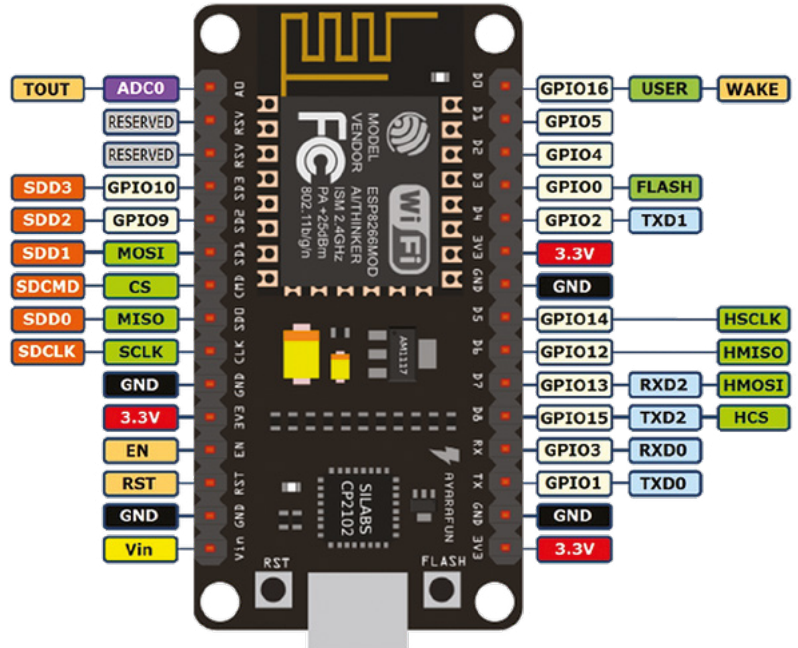

the dial is both a control and a display. If you change the thermostat remotely, you need to adjust the position of the dial to reflect the new settings.

This project relies on a low-cost servo connected to a potentiometer to control the position of the dial. When the user changes the target temperature using the webpage, the NodeMCU starts moving the servo, and checking the value of the potentiometer on the dial. When the potentiometer value reflects the target temperature, the servo disconnects. The project

requires minimal additional circuitry, but it does require access to a 3D printer to make the gears that connect the servo to the potentiometer. The best place to start is by printing these parts and assembling the dial. The printed parts are designed to fit into the lid of an IP55 junction box with all of the low voltage components,

but there's no real limitation on the enclosure that you use as long as it is electrically safe. Mains voltage parts of this project are fitted into a separate IP55 junction box near the heater. This second box contains a 5V power supply for the NodeMCU and servo, and a high-power solid state relay to control the heater.

With the dial assembled, you can start wiring up the potentiometer and thermistor as shown in the circuit diagram for the project. Flash the heater control sketch onto the NodeMCU, edit the code to match the username and password of your WiFi, and use the Arduino IDE's serial monitor or your router to find out the IP address assigned to the NodeMCU. Visiting the device's IP address in your browser →

**Above** ♦ The pinout of the NodeMCU can be a bit confusing if it's the first time you've used it. The pin labels on the board (D1, D2, etc.) don't actually refer to the pin numbers used in the Arduino IDE. The pin numbers recognised by the Arduino IDE are the GPIO numbers shown in this diagram. So, D1 on the NodeMCU is digital pin 5 in the Arduino IDE, and D2 is pin 4. There are some other constraints with the digital pins, because only pins D2, D5, D6, and D8 can be used for PWM control

**Left** ♦ The low voltage side of this project is quite straightforward

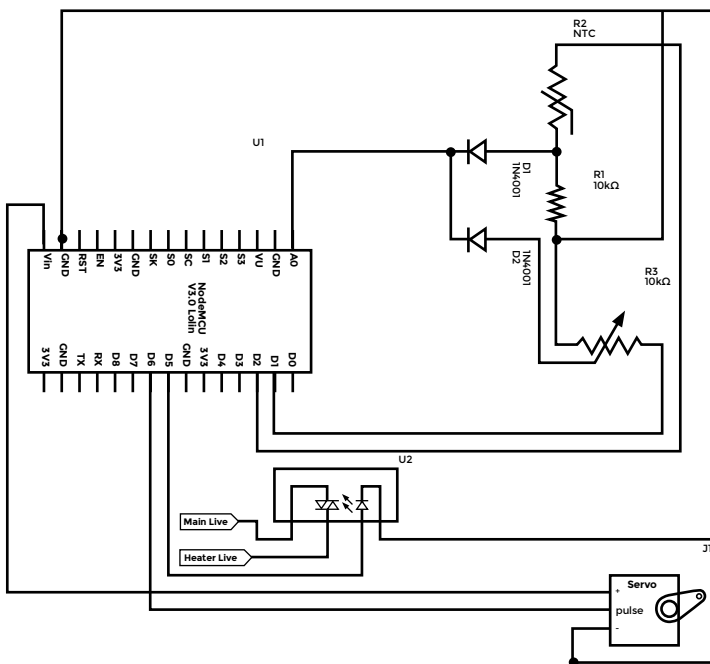



## TUTORIAL

### Right

The enclosure for the dial houses the NodeMCU and the thermistor, which is the metallic tube poking out on the left-hand side of this image. The thermistor could be mounted remotely, and the circuit and app could be modified to use multiple thermistors and relays. This might be useful if you want to monitor indoor and outdoor temperatures from your phone, or activate a fan to circulate air if one area gets significantly warmer than another

### YOU'LL NEED

- ◆ **NodeMCU**  
([hsmag.cc/zibTUx](http://hsmag.cc/zibTUx))
- ◆ **5 V PSU module**  
([hsmag.cc/L466kj](http://hsmag.cc/L466kj))
- ◆ **S3003 Servo**  
([hsmag.cc/LJDKyp](http://hsmag.cc/LJDKyp))
- ◆ **10 kΩ thermistor**
- ◆ **10 kΩ potentiometer**
- ◆ **10 kΩ resistor**
- ◆ **3 × 1N2001 diode**  
(or similar)
- ◆ **3D-printed dial and gear**
- ◆ **10 A 220 V Solid State Relay**  
([hsmag.cc/KHNtWb](http://hsmag.cc/KHNtWb))
- ◆ **Signal wire**  
(an old network cable is ideal)
- ◆ **13 A mains flex cable**  
(length to suit the requirements of your heater)
- ◆ **IP55 1-gang enclosure**  
([hsmag.cc/dVhAgB](http://hsmag.cc/dVhAgB))
- ◆ **IP55 2-gang enclosure**  
([hsmag.cc/LK6TrD](http://hsmag.cc/LK6TrD))



## GOING ANALOGUE

The NodeMCU has one analogue input, but this project uses two analogue devices. One solution would be to use an I<sup>2</sup>C sensor to measure the temperature, or use a chip like the MCP3008 to add a second analogue input. A simple room heater doesn't really need anything that complex, and you can use a technique called multiplexing to combine the outputs from the sensors into a single input, and read them sequentially. There are dedicated chips (like the 74HC4051) that will let you multiplex eight or more different analogue signals, and these are great if you want to expand this project to read from multiple temperature sensors.

For working with just a couple of analogue sources, it's easier (and uses fewer digital pins) to isolate the sensors from each other with a couple of diodes. The diodes will prevent the output from the sensors from interfering with each other, but you should be aware that they will also cause the readings from each sensor to be slightly lower than expected. This isn't a big problem, but it does mean that when you're doing something like calculating temperature from a thermistor, you will need to adjust the input value slightly to account for the effect of the diode on the input. Adding 97 to the input from the ADC works well for the temperature range used in this project.

should display a simple webpage that tells you the current temperature and the target temperature of the heater.

The dial assembly connects to the mains control box via three low-voltage wires. Two of the wires carry the 5V power to the dial assembly, connecting to the Vin and GND pins of the NodeMCU. The third wire connects to D5 (GPIO 14) on the NodeMCU, and



You should now be able to control the temperature of your workspace with a neat, reactive dial



carries the trigger signal to the solid state relay. With all of the low voltage wiring complete, now is a good time to check everything is working as expected. Power the NodeMCU with 5V, and experiment with the servo settings. You might have to fiddle with the positioning of the gears on the servo and dial to get the range of movement you need. It's easiest to remove the dial temporarily, set the temperature to 5°C (the minimum allowed temperature) using the



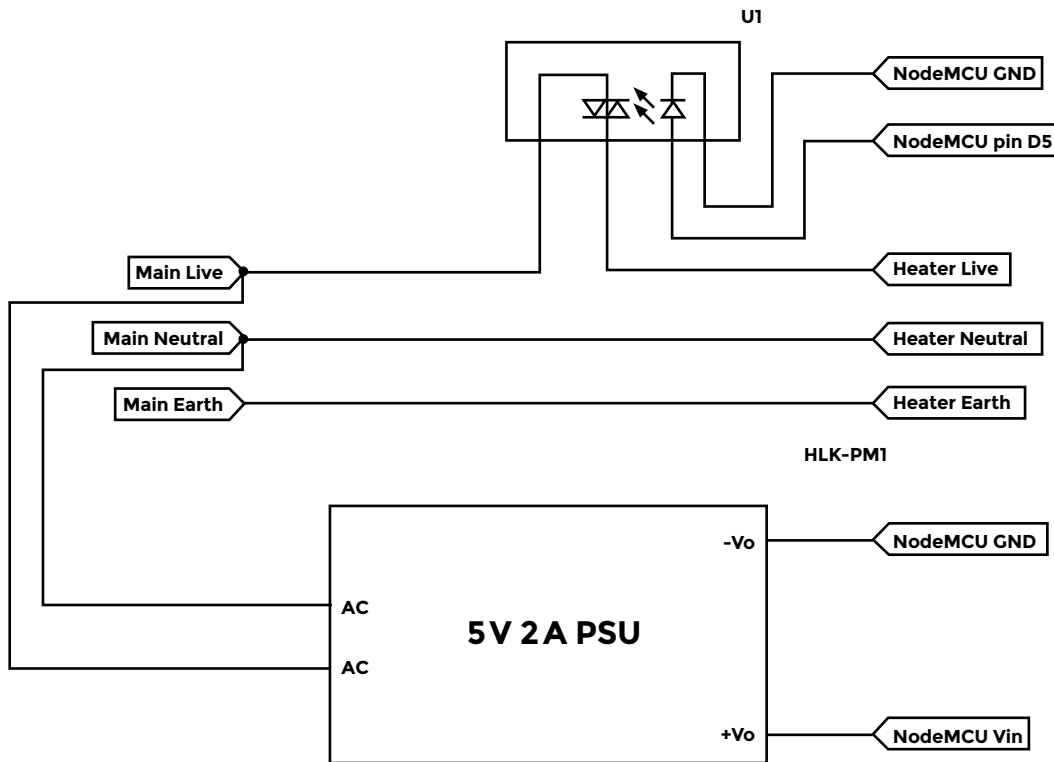

**Left** ♦ You need to supply mains voltage to the input of the 5V power supply with an appropriate fuse and an earth. The solid state relay is an electronic switch used to turn the heater on or off, and it should be connected in line on the live (brown in the UK) wire, between the heater and the plug socket. The neutral (blue in the UK) and ground (yellow/green in the UK) pass straight through to the heater

web interface, and then refit the dial so that it points to the appropriate position. Most solid state relays have a visible LED in them, so you can tell whether they are turned on or off without having to connect them to a mains device.

**RULE 0: DO NOT BE ON FIRE**

With everything connected, double-check the mains portions of the wiring to make sure there are no

crossed wires or short circuits, and then close the IP55 boxes, and screw them shut. Connect the power, wait a few seconds, and then try to access the temperature-control+ over the internet. If everything has gone well, you should now be able to control the temperature of your workspace with a neat, reactive dial that responds to internet instructions! □

**GETTING ONLINE**

This project uses the ESP8266 web server module to turn your NodeMCU into a tiny web server. This is a very powerful module that lets you set up a REST server with minimum code. It makes the NodeMCU a great, low-cost way of adding web functionality to existing hardware. It also makes it easy for someone to maliciously access your existing hardware if you don't have effective network security in place. The code for this project does limit the maximum temperature that a user can set remotely, but it doesn't include important security features like password protection. You should consider adding more security features if you intend to use the heater project on your own network.

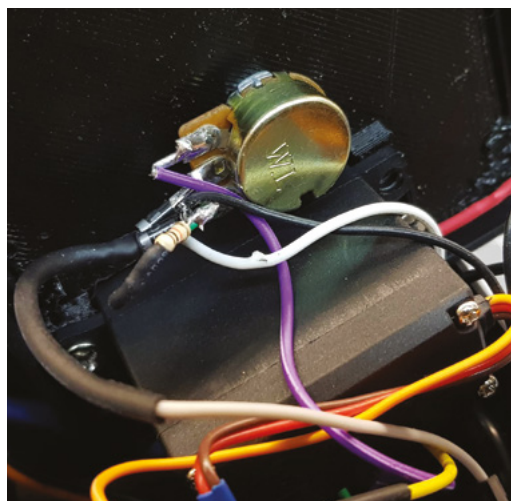

**QUICK TIP**

If your heater has a built-in (inaccurate) thermostat, you don't usually need to modify the heater to bypass it. Just turn it up to maximum, and it should stay on.

**Left** ♦ You don't always need a circuit board, as components can be joined with a bit of simple wiring





Right ↗ Making a floating herb garden is just one of infinite applications of these essential 3D modelling tips

# An introduction to functional 3D printing

Learn key aspects of functional design while recycling plastic pots



Glenn Horan

@BatGlenn13

Glenn is a software developer by day and 3D printing enthusiast by night. Rumour has it that building and troubleshooting cheap Prusa clones is what caused him to go bald before his years.

“Come with me, and you’ll be in a world of pure imagination...”

With 3D printing, if you can imagine it, you can print it (within reason of course). One limitation is the ability to use 3D modelling software. Take it from us that 3D modelling really isn’t as hard as it looks and, thankfully, functional prints are significantly easier than, say, sculpting a detailed action figure. There are however important paradigms that should be followed to make the most out of our new creations. We’re going to use Fusion 360 to run through how we designed our ring mounts to make a floating herb garden, show you how to add modifications to make them work in different scenarios, and introduce you to some important 3D modelling concepts along the way.

In issue 28 of HackSpace, we gave you an introduction on how to use Fusion 360, using a vase as an example. While that knowledge is a good foundation for this tutorial, you should be able to follow along fine without it. If you’re completely new to Fusion 360, you’ll be glad to know that it’s free for hobbyists – you just need to sign up and download it from this link: [hsmag.cc/Kbg7IE](https://hsmag.cc/Kbg7IE). While Fusion 360 is downloading, you can start to take the physical measurements we’ll need to make our functional print. Digital callipers are great here as we can use them to conveniently and accurately measure objects/gaps/hole diameters etc., but for this project, a ruler is fine.

### SAGE AGAINST THE MACHINE

Using our pots as an example, we first need to measure the diameter of the pot for the main ring



## TOOLS FOR THE JOB

If you are planning on doing a lot of 3D modelling, a set of digital callipers are essential. They are also useful when it comes to calibrating your printer, as you can find out the true dimensions of those calibration cubes you've been printing and even check the diameter of your filament to make sure it really is 1.75 mm thick, as advertised. With a little bit of shopping around, you can pick up a set of digital callipers for as little as £7, but the quality and accuracy won't be great. A nice sweet spot can be found at the £15 mark for a good bump in quality and accuracy (0.01 mm rather than 0.1 mm for the cheaper sets).

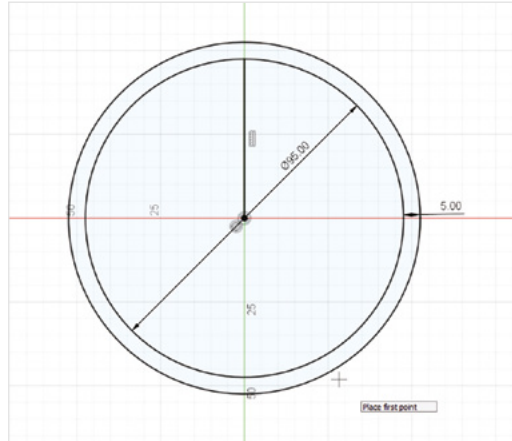

## YOU'LL NEED

- ◆ Fusion 360
- ◆ 3D printer
- ◆ Digital callipers (though a ruler will do)

**Figure 1** ◆ Note the small doughnut symbol in the centre, beside the origin. This is the symbol for the Concentric constraint that we've added to these two circles

of our piece, followed by the thickness of the fence post, and the width of the gap. We measured our pot just below the top rim, where it is a little thicker, to find it is 95mm wide, the fence posts are 21 mm thick, and the gap is 21 mm wide. With these three dimensions, we can jump right in and start designing on Fusion 360.

As the shape we are trying to create is pretty basic, we're going to start by simply drawing a 2D representation of the shape and then extrude

draw another circle using constraints to make sure the two circles will always be concentric.

## PLEASE, CONSTRAIN YOURSELF

While absolute precision for the diameter ring isn't vital for this particular project, it's good practice to define our dimensions and to use constraints (see Constraints box overleaf for details). To really get a good idea of what's happening here, we're going to draw a second circle, but this time don't start on the origin. Draw it anywhere on the screen and give it a diameter around 20mm larger than the previous circle. To make this into a ring, we're going to add the Concentric constraint. Click on the Concentric icon from the Constraints menu in the top of your UI toolbar (a red circle with a black circle inside it). Finally, we're going to click on our two circles one after the other. The second circle should snap on top of the first circle. We're going to finish the ring by adding a dimension between the two circles. →

**// We're going to start by simply drawing a 2D representation of the shape and then extrude it into a 3D object //**

it into a 3D object. In Fusion 360 this 2D image is called a sketch, and in our case, it'll be made up of a few different pieces – a couple of circles and two rectangles. Easy!

Once Fusion 360 is set up, and you've selected a new project, click on the Create Sketch button in the top left of your UI. You'll be prompted to select a plane – select the XZ plane (the bottom surface). From here we're going to draw a circle by clicking on the circle tool in the top left of the UI, and then clicking on the origin (the small circle in the centre of your screen). After you've clicked on the origin, you can move your mouse around to make the circle bigger or smaller. Because we're being more precise here, we'll want to input the dimensions manually. Use the measurement from the diameter of the pot we're going to be putting in here – in our case, it was 95mm. To complete the ring, we're going to

## WHY A FLOATING HERB GARDEN?

There's a real satisfaction in looking at something around the house/office/workshop that you want to fix and then coming up with a solution from design to physical object. In the author's case, he had an ever-increasing number of plastic pots left over from lunches, and wanted to find a novel way to recycle them. Being fond of a bit of cooking, herb planters seemed like a good idea, and the thought of having an extensive herb garden to choose from was too good to pass up. By having the plants off the ground, they're safe from creepy crawlies (and his dog Floki), and they will get sunlight for more hours in the day.

## QUICK TIP

The completed project can be found here: [hsmag.cc/Xce2wM](http://hsmag.cc/Xce2wM)



**Figure 2** ◆  
When adding the symmetry constraint, select the two features you want to be symmetrical before selecting the feature that will represent the line of symmetry

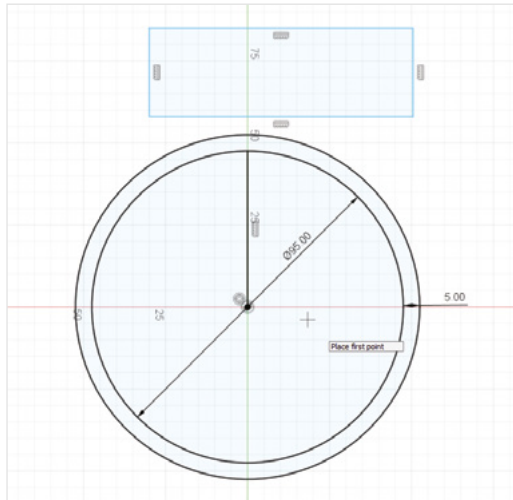

Click on the Sketch Dimension button at the top left of the UI (two vertical lines with a double-headed arrow between them). Then click on the two circles one after the other again, and move your mouse off the side and click. You should see a small text input box where you can enter the dimension. 10 mm is a bit much here, so let's go for 5 mm. You should now have what you can see in **Figure 1**.

Next, we need to draw our two rectangles, with constraints, of course, to make sure everything is nicely centred and symmetrical. To do this, first select the Line Sketch tool and draw a line from the origin to the top of the outer circle (this is important!), and then use the Rectangle tool to draw a rectangle above the circle (**Figure 2**). We'll add the dimensions in a second. First, we're going to use the Tangent constraint to ensure our rectangle is tight against the ring – click on the Tangent button from the Constraints toolbar (red circle with a black line on it) and then click on the bottom line of the rectangle we've just drawn followed by the larger of our

### CONSTRAINTS

Constraints are a very useful way to define relationships between different sketch objects. You can define if a line should always be at a tangent to a circle, if two features should always be symmetrical to each other, if two lines should always run parallel or perpendicular to each other, etc. While this is obviously useful at face value, it becomes vital if you need to edit any dimensions in your sketch while preserving the important relationships. You can find Constraints in the top centre of your UI when you're in the Sketch menu.

### QUICK TIP

Some digital callipers come with 'feeler gauges' which are awesome for bed levelling

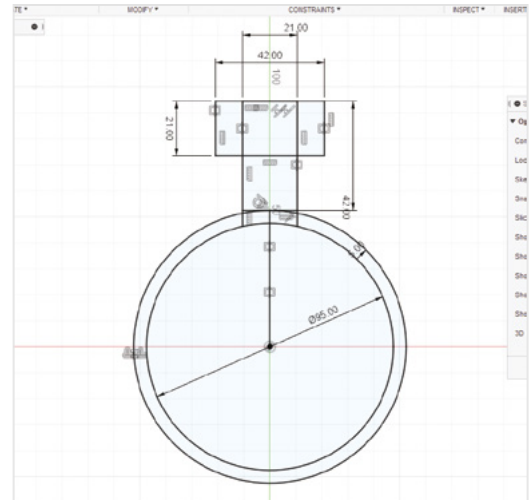

**Figure 3** ◆  
The finished sketch with all constraints and dimensions. Notice the small lines drawn to connect the ring to the rectangle

two circles. Next, we'll centre it by clicking on the Symmetry constraint (dotted line between two halves of a rectangle), then clicking on each of the two sides of our rectangle followed by the line we drew in the middle of our circle. The rectangle should snap to the centre. We can set the dimensions of our rectangle by clicking on the Sketch Dimension button and then the sides of our rectangle. The height of the rectangle will be the thickness of our fence post, and the width will be the size of the gap between the two fence posts (21 mm each in our case).

### TWO RECTANGLES + TWO CIRCLES = FUNCTIONAL DESIGN

Our final rectangle will go above the previous one. Sketch a rectangle (a little above the rest of our sketch), then use the Collinear constraint to ensure they're always touching by clicking the top line of our previous rectangle and the bottom line of our new one. We can add symmetry the same way as we did previously, using the line in the centre of the circle as our line of symmetry. As for dimensions, this rectangle should be around 20 mm tall and 20 mm wider than the previous one. Finally, draw two small lines to better connect our first rectangle to the ring (see **Figure 3**) and click on the green tick on the top right of the toolbar to finish the sketch.

The hard work is all finished at this stage – we just need to make it 3D. Select what we want to extrude by clicking on the inside of one of the rectangles

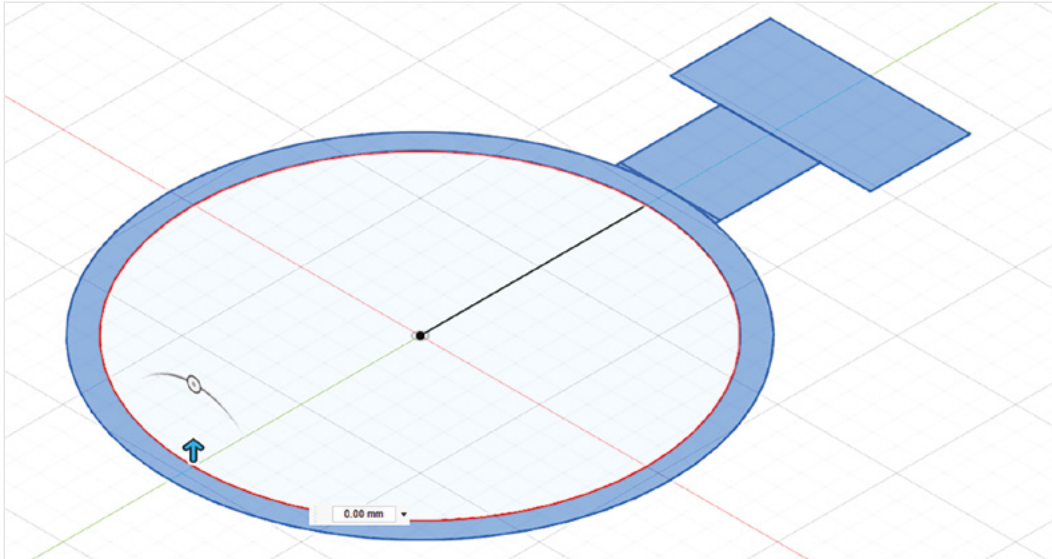

**Figure 4** ♦ In order to extrude, you may need to change your view using the view cube in the top right of your viewing pane. Hover over it, then click the Home button that appears

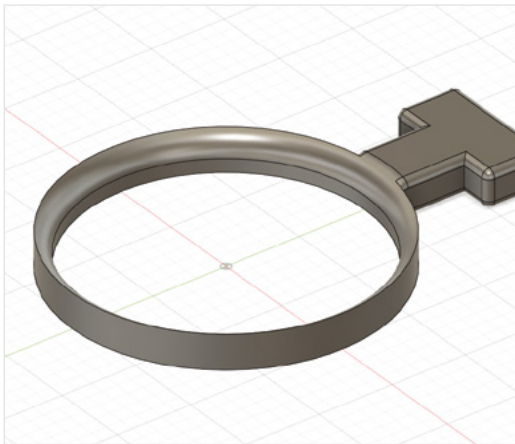

**Figure 5** ♦ Select an edge and click on the Fillet button from the toolbar at the top of your screen. An arrow will appear on your model; drag it left and right to smooth the selected edge(s)

(it should turn blue). Then, while holding the **CTRL** key (⌘ for Mac users), start clicking on the inside of all the shapes we drew until the whole shape is blue (**Figure 4**). In the top right of your toolbar, click the Extrude button (blue cube with an arrow) and then drag the small blue arrow that appears beside our sketch – around 10 mm sounds about right. Congratulations! You have a functional prototype (**Figure 5**). All that’s left is to print our pot holder. First, save your work, then go to File > Export and export it as an STL file. From here, load it into the slicer of your choice and print it as you would any other model. □

**MAKE IT YOUR OWN!**



The joy of 3D modelling is that you can make this project your own. Maybe you have no interest in gardening, but still want to make use of some old pots or containers you have lying around. We’ve quickly sketched up some inspiration if you want to edit this concept for something that will fit in a pegboard (for holding screws, paintbrushes, or other bits and pieces) and another design with a backplate with screw holes to be mounted virtually anywhere.



**QUICK TIP**  
A well-calibrated 3D printer is useful for ensuring the dimensions you set in Fusion 360 match your finished print.



# BOOK OF MAKING

VOLUME 2



ONLY  
**£10**

WHSmith  
BARNES & NOBLE



THE BEST  
PROJECTS FROM  
**HACKSPACE  
MAGAZINE**

THE ULTIMATE SKILLS,  
TRICKS, AND MAKES

**AVAILABLE NOW**

[hsmag.cc/store](http://hsmag.cc/store)

FROM THE MAKERS OF **HackSpace** MAGAZINE

THE *Official*

# RASPBERRY PI PROJECTS BOOK

VOLUME 5

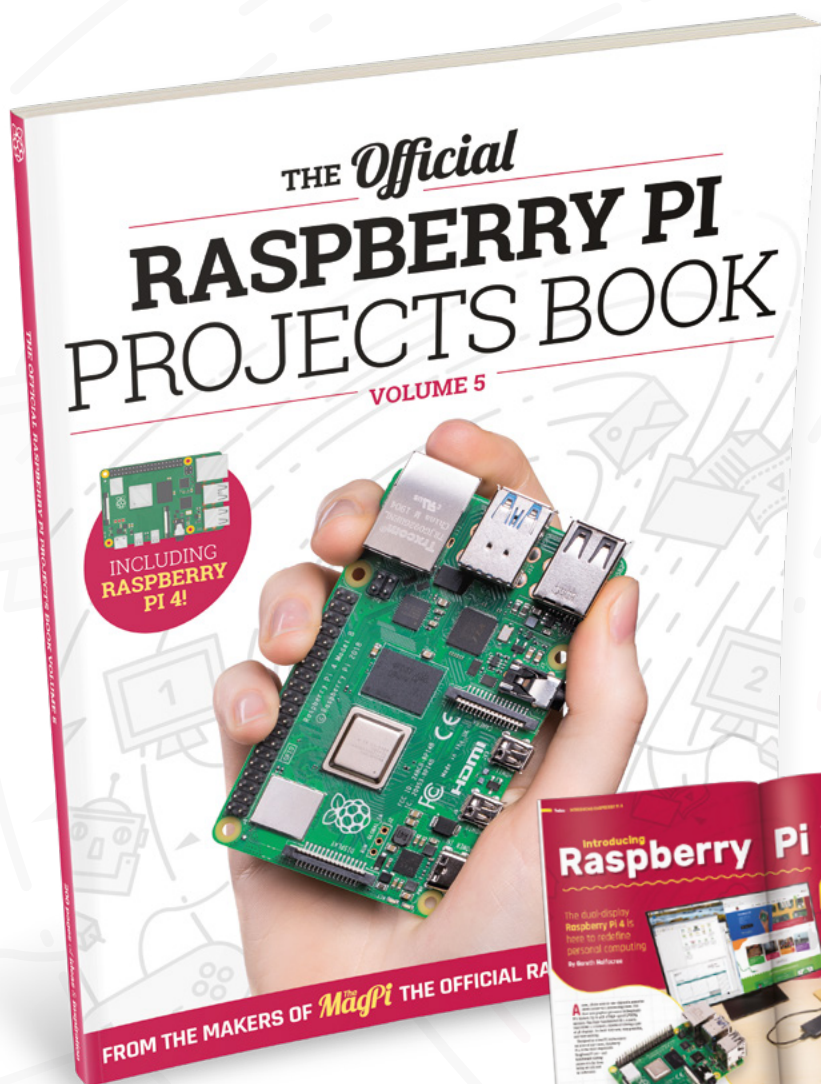

## 200 PAGES OF RASPBERRY PI

- Use Raspberry Pi 4 as a desktop PC and 4K home media centre
- Be inspired by incredible projects made by other people
- Learn how to code and make with our step-by-step tutorials
- Find out about the top kits and accessories for your projects



Buy online: [magpi.cc/store](https://magpi.cc/store)



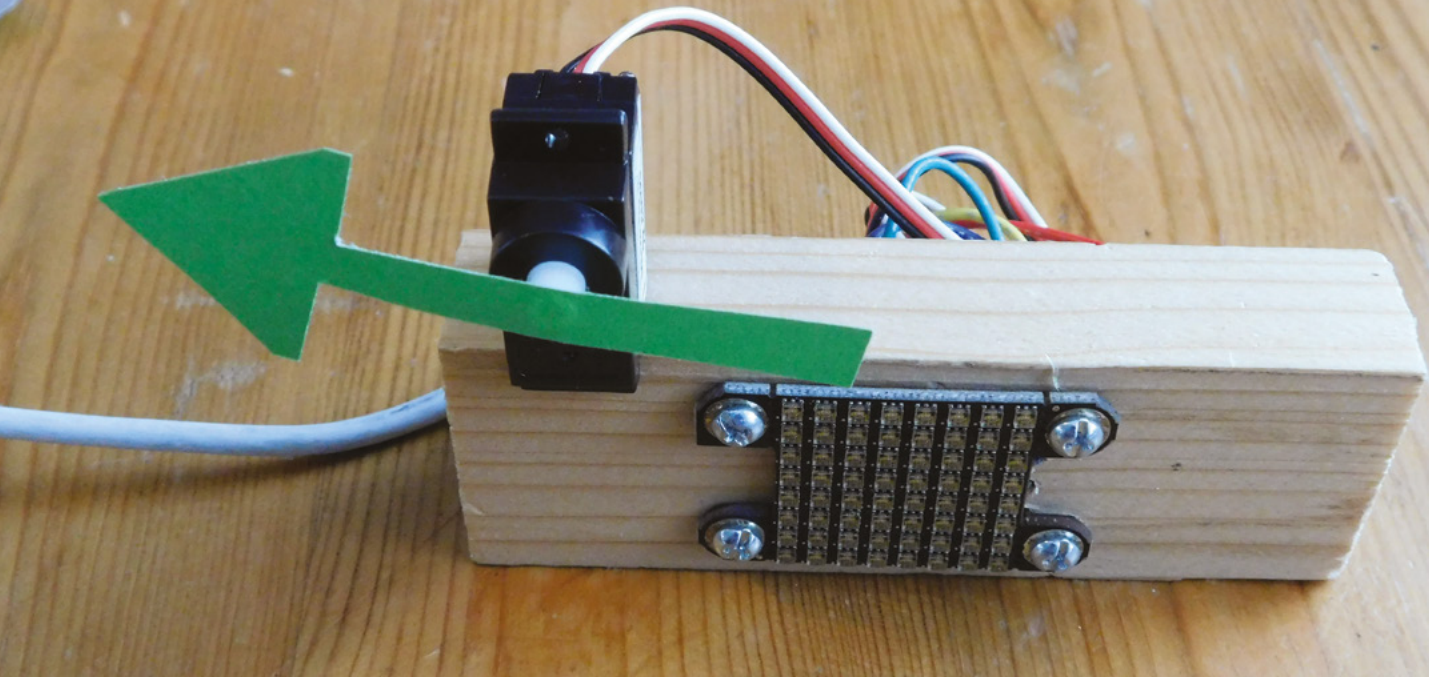

# Monitoring Air Quality

Keep an eye on what you breathe with an ESP32 and a servo



Ben Everard

 @ben\_everard

Ben is a maker and keen cyclist which means he has a keen interest in the air around him and the skills to find out what's in it.

#### Above

Our final data display sitting on our desk as a constant reminder that our health is inextricably linked to the quality of air around us

**H**ackSpace magazine is edited in Bristol, and like many cities around the world, Bristol has a problem with clean air. Currently, the council is considering an outright ban on privately owned diesel cars. However, is this needed? Is air quality a problem? If so, what should we do about it? We think the first step with this, as with many things, is to understand the problem – that starts with understanding the data.

As with most cities in the UK (and elsewhere), there is a range of air monitoring stations that provide information about the current state of the environment. You can view live and historical data at [hsmag.cc/Dwoa1w](https://hsmag.cc/Dwoa1w).

We wanted a way to subtly keep an eye on air quality without having to go to the website to check it. We took inspiration from Google's Paper Signals project, which uses servos and bits of paper to display live information. Bristol air quality is not supported by Paper Signals, so we had to build our own.

Although this build uses a data feed that's specific to Bristol, there are similar feeds for other geographical areas, and different types of data,

so you can use this process to display a range of different things.

There's an API which lets us download the data in a machine-readable format (in this case, JSON), and even an API builder tool which helps us create the right request to get the data at [hsmag.cc/qPoqTK](https://hsmag.cc/qPoqTK).

Using this, we can limit the results to just the air monitoring station closest to our office (AURN St Paul's), and only get the latest reading. The final URL for retrieving this data is:

```
https://opendata.bristol.gov.uk/api/records/1.0/search/?dataset=air-quality-data-continuous&rows=1&sort=date_time&facet=date_time&facet=location&facet=current&refine.location=AURN+St+Pauls
```

The 's' at the end of HTTPS shows that this is using encrypted data transfer, and this is both a good and bad thing. It's good because it means that we're taking advantage of modern security, but it's bad because microcontrollers can struggle with encryption as it's a bit RAM and CPU heavy. Fortunately, the ESP32 is powerful enough to handle it, so that's our hardware of choice for this project. Now, let's look at getting the data first.

Arduino on the ESP32 has a library we can include that brings in WiFi and the ability to access HTTPS documents. We bring it in with the line:

```
#include <WiFiClientSecure.h>
```

With this, we can connect to the network and download the data with:

```
WiFi.begin(ssid, password);
while (WiFi.status() != WL_CONNECTED) {
  Serial.print(".");
  delay(1000);
}

client.setCACert(test_root_ca);

if (!client.connect(server, 443))
  Serial.println("Connection failed!");
else {
  client.print((String)"GET /api/records/1.0/
search/?dataset=air-quality-data-
continuous&rows=1&sort=date_time&facet=date_
time&facet=location&facet=current&refine.
location=AURN+St+Pauls HTTP/1.1\r\n" +
    "Host: " + String(server) + "\r\n"
+
    "Connection: close\r\n\r\n");
```

The key bit missing from this is the variable `test_root_ca`. To understand what that is, you first need to understand a little about how HTTPS works. When downloading secure documents on the web, we use a thing called public-key encryption. With this, there are two keys: a private key and a public key. Anything encrypted with the private key can be decrypted with the public key. This way, the website can advertise the public key and encrypt things with the private

"

When downloading secure documents on the web, we use a thing called public-key encryption

"

key. We can use the public key to decrypt the data and then be sure that it really came from the website. However, this raises the question, how do we know that the public key is really the public key? Well, we use public-key encryption, and it's encrypted with the private key of a certificate authority. Well, how do we know that the certificate authority's public key is really correct? Well, it's encrypted with the public key of ...



At some point, this chain of trust has to stop, and there has to be an original public key that we trust implicitly. This is known as the root authority. There are a few around, and you have to make sure that you have the root certificate that's used by the website you're trying to get data from. In our code ([hsmag.cc/FbMO49](#)), we've included the root certificate that's used by Let's Encrypt, which is a popular certificate provider, so there's a good chance that it'll work for other sites, but if it doesn't, take a look at the box below for details on how to find it out. →

**Above** ♦ The ESP32 is a great choice for this project because, as well as having WiFi, it also has the processing power to decrypt HTTPS data

## FINDING THE ROOT CERTIFICATE

If the site you need to get data from doesn't use the same root certificate as us, here's how you can find the correct one:

- Open the URL in Firefox (we found this the easiest browser to use)
- Click on the padlock in the URL bar, then on Connection secure, and then More information
- In the pop-up, click on View certificate. This will open a new browser tab with sections for each of the certificates in the chain
- Select the left-most option in the certificate chain (which will probably have a name including the word 'Root')
- Scroll down and press Download PEM(cert).
- Open this file, and the contents of this needs to go in the `test_root_ca` variable



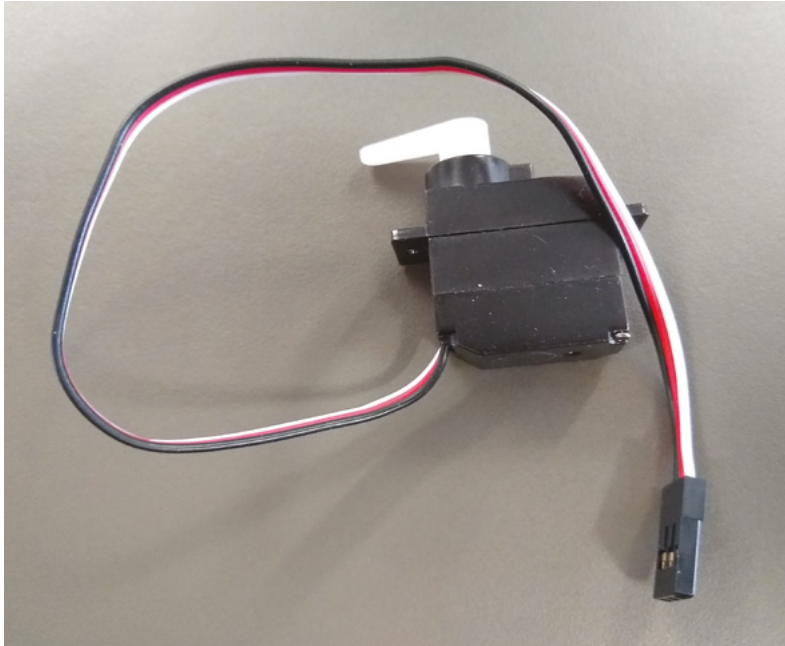

**Above** ♦  
Servos are motors combined with feedback and control electronics to let you easily turn them to a set position with your code

The previous code will download the text containing the data we want, but we need to pull out the relevant information. In our case, we're interested in the NO<sub>2</sub> reading. The data is encoded using a format called JavaScript Object Notation (JSON). Fortunately, there's an Arduino library that understands this, and we can use it to get the data out automatically:

|| The data is encoded using a format called JavaScript Object Notation (JSON). Fortunately, there's an Arduino library that understands this ||

```
String line = "";
while (client.available()) {
  line = client.readStringUntil('\r');

  if (line.indexOf('{')>=0) {
    DynamicJsonDocument json_doc(6000);
    DeserializationError json_error =
deserializeJson(json_doc, line);
    if (json_error) {
      Serial.println("parseing failed");
      Serial.println(json_error.c_str());
    }
    else {

      Serial.println("NO2");
      String no2=json_doc["records"][0]
["fields"]["no2"];
      Serial.println(no2);
    }
  }
}
```

**Right** ♦  
We're a bit lucky that the LOLIN32 happens to have pins in the correct position to slot our servo straight into the pin headers

```
    }
  }
}
```

A lot is going on in here, but most of it is just shuffling data from one place to another. First, it's read from the client (which is the HTTPS client), and then `deserializeJson` is called, which converts the string of text into a data object that we can extract the necessary data from. The JSON doc is a hierarchical data structure. You can think of it as the directory structure in a computer where there's a root, and inside of this, there can be either named folders or named files (they can be ordered as well as named in this case – if they are, we use a number to extract the one we want). We need to navigate this structure to get out the pieces we need. In our case, the latest NO<sub>2</sub> reading is at `json_doc["records"][0][ "fields" ][ "no2" ]`;

### DATA IN AND DATA OUT

Now that we've got the data, the next step is to find a way of displaying it. We decided to use a servo to make a simple pointer. We're mounting this on top of an LED weather display (see HackSpace magazine issue 24), and didn't want any more lights on there.

Our servo has a 180-degree range, and we decided to have 0 degrees (horizontal, pointing left) as zero milligrams of NO<sub>2</sub>, and 180 degrees (horizontal pointing right) as 40 milligrams. This is the maximum legal limit for air in the UK.

Servos have three pins to connection: ground, power, and data. Ground should be connected to ground, power to 5V, and data to any IO pin. It just so



happens that on the LOLIN32 that we're using, there are three pins in the right order with pin 13 above 5V and ground. Not all servos have the pins in this order, so check yours before plugging it in. If your servo doesn't line up with the pins on your microcontroller, then just use some header wires, a breadboard, or solder them in place.

Servos are controlled with PWM signals; however, the ESP32 handles PWM in a slightly different way to most Arduino-compatible boards, so you can't just use `analogueWrite`. Fortunately for us, there's an Arduino library that does all the heavy lifting – ESP32Servo. You'll need to install this via the library manager; then you can include it with the line:

```
#include <ESP32Servo.h>
```

We need a few bits to get it set up and running with our servo on IO13:

```
Servo myservo;

int pos = 0;
int servoPin = 13;

void setup() {
    myservo.setPeriodHertz(50);
    myservo.attach(servoPin, 500, 2500);
}
```

The two numbers on the `myservo.attach` are the minimum and maximum pulse lengths. You might need to tweak them a little for your servo, but these worked for us.

The only thing we need to do now is use `myservo.write(pos)` to set the servo to `pos` number of degrees.

**Below** ♦

Open Data Bristol has a dashboard for viewing the live air quality figures, as well as an API that lets you get the data from the back end

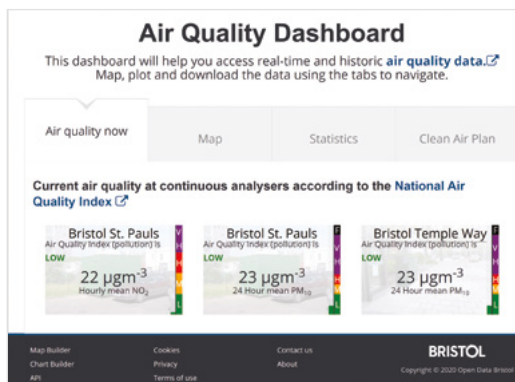

**Above** ♦

It's easy to over-complicate data displays – sometimes a bit of card glued to a servo is all you need

We need to convert our number of micrograms of NO<sub>2</sub> to a position for the servo, and we can do this with the line:

```
myservo.write(min(no2.toFloat()*4.5,180.0));
```

The data for NO<sub>2</sub> that we extracted from the JSON may look like a number, but it's actually text containing the digits. We can use the `toFloat()` method to change this into a float data type. Multiplying this by 4.5 converts it into the position of the servo, but in the event that Bristol exceeds its legal air quality limits, we need to use a `min` function to make sure that we don't try and go beyond the range of the servo.

That's the code sorted; it's time to set everything up physically. Generally, servos come without their arms attached, so the first job is to attach the arm pointing in the correct direction. When you first turn on the build, the servo will go to zero degrees, so at this point you can attach the arm. Of course, you don't want just a bare arm, so you can adorn it with whatever decoration you like. We went with an arrow, but you can be more creative if you like. There should be holes for small screws to attach decoration to the servo arm, but for something like this with little force, a drop of superglue does the job just as well.

That's all there is to making a simple data visualiser. What will you make yours display? □

**DATA FEEDS**

There are loads of data feeds around, but often the most useful ones are the ones local to you. We looked at using a weather feed in issue 24, and you could easily adapt this little pointer to display temperature, wind speed, or something else.

There's a wide range of transport feeds from trains to road networks that could equally drive a similar display, should that information be useful.

You could also build your own sensor and have it set up to serve information as JSON and create your own personal data network if you wish.



# Level shifting

Helping digital devices talk to each other



Ben Everard

@ben\_everard

Ben loves cutting stuff, any stuff. There's no longer a shelf to store these tools on (it's now two shelves), and the door's in danger.

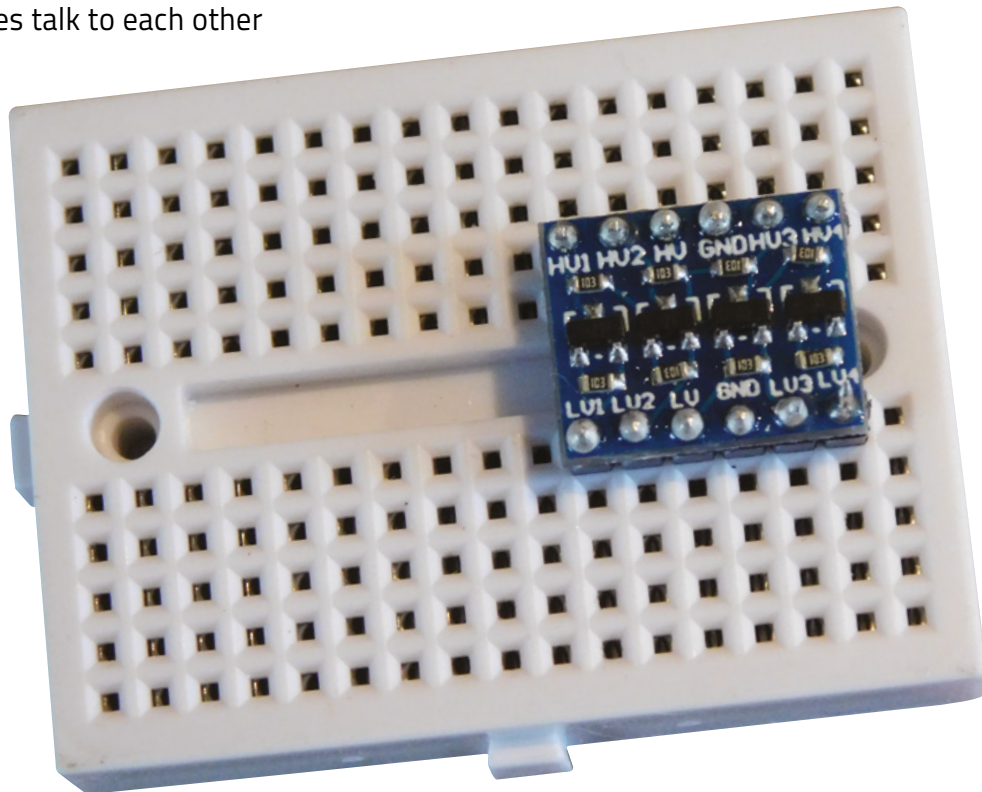

**W**e often talk about digital signals being either 'on' or 'off', '1' or '0', but it's not quite as clear-cut as this. Because different components work at different signals, what one

module considers 'on', another might consider 'off'. This mostly comes down to the voltage that a device works at. Most hobbyist components work at either 3.3V or 5V, though you might come across some other voltage levels.

There can be a little leeway for working with these different voltage levels, for example, a 5V system may be able to take input from a 3.3V module (though it's quite rare for a 3.3V device to be able to take 5V input).

Often, however, we need a way of adjusting the voltages of signals too, and for this, we need a level shifter. These come in various forms. The biggest difference between the types is whether they're one-way or bidirectional.

## AC/DC

Perhaps the most electrically complicated form of switching is controlling alternating current (AC) from a direct current (DC) microcontroller. Fortunately, there's a very easy way of sidestepping all the electrical complexity: relays. These are magnetically controlled switches where a DC signal turns a magnet on and off. This magnet flicks a switch and can control a wide variety of electrical connections. Since the input and switched circuit are entirely separate, a DC signal can switch an AC signal without problems. There are still electrical limits on relays, so you do have to make sure that your relay is up to the job in hand, but it's easy to get ones capable of switching mains-level current. However, if you're going to use it for high-voltage applications, you need to make sure that you understand the safety implications of this, particularly around making sure the entire circuit is properly insulated (and will remain so under the rough and tumble of daily use) so no stray fingers come into contact with high voltages.

**Above** A simple MOSFET-based level shifter board with four channels will typically only cost a couple of pounds

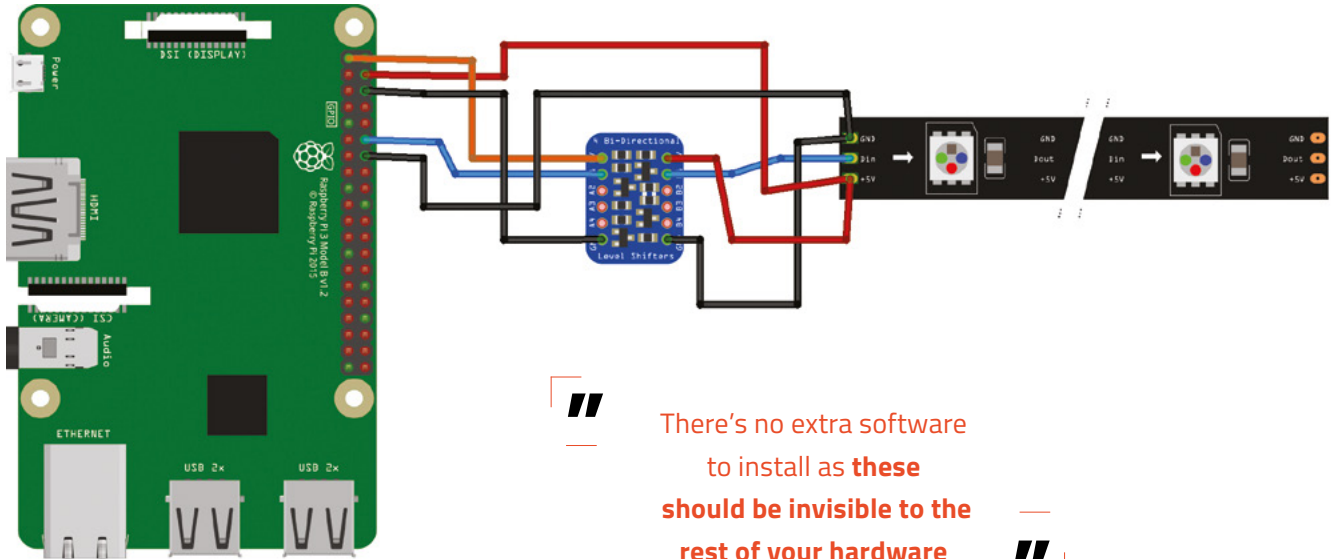

“ There’s no extra software to install as **these should be invisible to the rest of your hardware** ”

While there are quite a few different options out there, our favourite is a MOSFET-based bidirectional shifter. These, as the name suggests, can convert in both directions, so you can send data backwards and forwards between devices of different voltages. They typically come in modules which convert four or eight separate IO lines, and only cost a few pounds. They can also handle I<sup>2</sup>C communication which can be tricky for some level converters.

Let’s take a look at how to use these – there are more or less identical modules from a wide range of different suppliers.

The modules have a low voltage side and a high voltage side. Low voltage inputs are usually labelled LV1 ... LV4, while high voltage ones are HV1 ... HV4. Each side also needs a power supply labelled LV/GND and HV/GND. As these are bidirectional, it doesn’t matter which is input and which is output (or, indeed, if they’re both, as in the case of I<sup>2</sup>C). All you

have to do is connect up the power, and then put your communication channel through a level shifter. See **Figure 1** for how to connect up a NeoPixel.

There’s no extra software to install as these should be invisible to the rest of your hardware – as far as your microcontroller is concerned, it’s communicating with a device at the same voltage level as it. □

**Figure 1** □ The blue wire supplies a 5V signal to the NeoPixels despite taking a 3.3V signal from the Raspberry Pi board

**Below** □ You can get dedicated level shifting chips.

### DRIVING MORE CURRENT RATHER THAN VOLTAGE

We’ve talked quite a bit in this article about changing between higher and lower voltage devices, but some components need more current than a particular IO can supply. There are a few ways of dealing with this.

Motor driver modules are designed to drive high-current motors, and can be repurposed for other high-current devices such as bright LEDs – just make sure that the voltages are correct, and the driver can handle the current load of the device.

While motor drivers work and come in a huge range of configurations, they can be a little overkill. The simplest way of driving extra current is with a transistor. You’ll also need a couple of resistors to get the correct current draw, so it’s not quite as simple as plugging in a module.

If you need a bit more current than a transistor can supply, but still don’t need to go all the way to a motor driver, Darlington pairs are an arrangement of two transistors to give you more power. For example, the ULN2803 chip gives eight channels of output, each of which can have up to 500 mA of current.

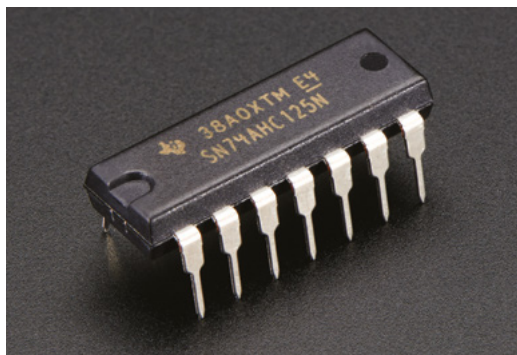



DON'T MISS THE **BRAND NEW** ISSUE!



**SUBSCRIBE FROM JUST £5**

- ▶ **FREE!** 3 issues for the price of one
- ▶ **FREE!** Delivery to your door
- ▶ **NO OBLIGATION!** Leave any time

**WORTH  
£20**

**FREE PI ZERO W  
STARTER KIT\***

With your 12-month subscription to the print magazine

**magpi.cc/12months**

\* While stocks last

**Buy online: store.rpipress.cc**



# FIELD TEST

HACK | MAKE | BUILD | CREATE

Hacker gear poked, prodded, taken apart, and investigated

PG  
114

## DIRECT FROM SHENZHEN: ENDOSCOPE

Peek inside pipes,  
enclosures, and containers

PG  
122

## CAN I HACK A GAMES CONTROLLER?



Find new ways of putting  
your thumbs to use

## REVIEWS

124

Fan SHIM

Keep your cool



126

:MOVE mini MK2

A robotic kit for beginners



128

Mini Trooper

Let robotic battle commence!

PG  
116

## BEST OF BREED

Raspberry Pi cases come  
under the microscope

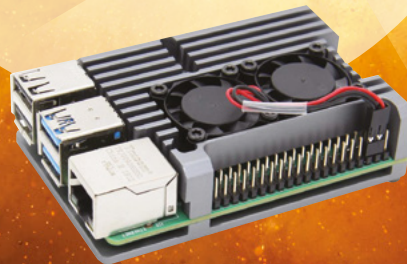
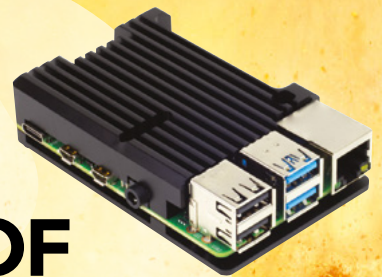





# USB endoscope

Peer into nooks and crannies

By Ben Everard

 @ben\_everard



**Above**  The ring of LEDs seemed well-matched to the needs of the camera, and we were able to take good images in both dark and light situations

**E**ndoscopes have a scary reputation because of their medical applications. However, they are just cameras that are easy to get into places that are otherwise difficult to reach. In

medicine, that's the internals of the human body but, for makers, that can mean enclosures that are hard to open, complicated assemblies, and other nooks and crannies.

We bought an Antscope 7 mm/5.5mm 1M Mirco [sic] USB Endoscope 2m 6LED Endoscope Camera Android Waterproof Pipeline PCB PC Inspection Mini Camera from Antscope Camera Store on AliExpress for £3.33, including delivery to the UK.

**//** Using the endoscope was entirely straightforward for us on Windows **//**

Using the endoscope was entirely straightforward for us on Windows. We just plugged it in and the system detected it as a USB webcam, and we could use it with any webcam software. There's a scroll-wheel on the side of the USB plug that turns the LEDs around the camera up and down in brightness, but otherwise, there are no controls.

Our endoscope came with a two-metre cable (a one-metre option was available), and a full-size USB plug (micro USB is available for use with phones).

This is a 0.3-megapixel camera – incidentally, it's a nice surprise to see a camera accurately claiming its



resolution in megapixels, and not scaling the video feed up to some excessively high number. The spec says 0.3 megapixels, and we get 0.3 megapixels.

At this resolution, it's obviously never going to take any images that will take Instagram by storm, but it's a £3.33 camera, so that's perfectly OK with us.

The LEDs are about the right brightness for the camera, and objects are in focus between about 3 and 15 centimetres from the lens.

### TAKING PICTURES

The resolution and picture quality aren't quite high enough to make this camera suitable for fine inspection work. You can use it to, for example, check surface mount soldering work, but you'll struggle to see problems if you're using the very smallest components around. For larger inspection

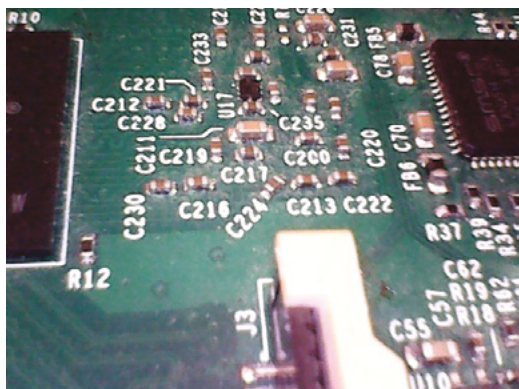

work, this camera is more than capable – checking that wires are connected in the right place, tubes aren't blocked, and other inspection that doesn't require seeing things that are fractions of a millimetre across.

There could definitely be applications for this camera in robotics. While it doesn't have the field of vision or resolution of, say, a Raspberry Pi Camera Module, it has a much, much smaller cross-section and built-in LEDs. For example, it could work really well for a robotic hand to see what it's about to pick up.

For the avoidance of doubt, we're not recommending this for medical uses. Honestly, we have no idea if it would be any use in a hospital. It looks a little on the large side to be comfortable to us, but we're makers, not doctors.

There are certain tools you know you need – if you've got nails, you only spend so long trying to bash them in with a rock or a large spanner before accepting that a hammer really is the best tool for the job. However, there are some tools that you don't always know you need, and an endoscope is one of these. Have you ever tried to work out what's going on inside a box by feeling it out with your fingers? Or, taken apart something to see what the problem was, only to find out that the problem was somewhere else, and you didn't need to take it apart in the first place? For these jobs, an endoscope is a great tool, but if you don't know that they're available, you might not think that it's one you need. □

**Above** ♦ You could lengthen this with a USB extension if you needed a little extra reach

**Left** ☒ Most of the electronics are hidden in the USB plugging

**Below** ☒ The image quality isn't brilliant, so would struggle a bit with PCB inspection (higher resolutions are available)



ONLY THE BEST

# Keeping your projects safe

Enclosures for your Raspberry Pi

By Marc de Vinck

 @devinck

**M**ost 'getting started with' Raspberry Pi kits include some kind of a basic case. But as soon as you start building circuits, adding components and sensors, you often outgrow the case, or you need to modify it.

Many people, including this author, will end up prototyping with a loose Raspberry Pi computer on their desk. Inevitably, there will come a time when something isn't working properly, and that loose board sitting on top of a stray wire lead, loose screw, or anything conductive, will wreak havoc with your project. Best-case scenario: you find the short, move your board, and everything works once again. Worst-case scenario: you short something out and destroy your board! Either way, you'll learn a valuable lesson – you need a case for your Raspberry Pi board!

When this author first started researching cases for Raspberry Pi, he was really surprised at how many variations there were available in the market. There are cases for Raspberry Pi cluster computers, industrial-rated cases, really inexpensive and simple versions, and a lot of robust and deluxe versions. Be sure to head online and look at all the available enclosures for your next Raspberry Pi project.

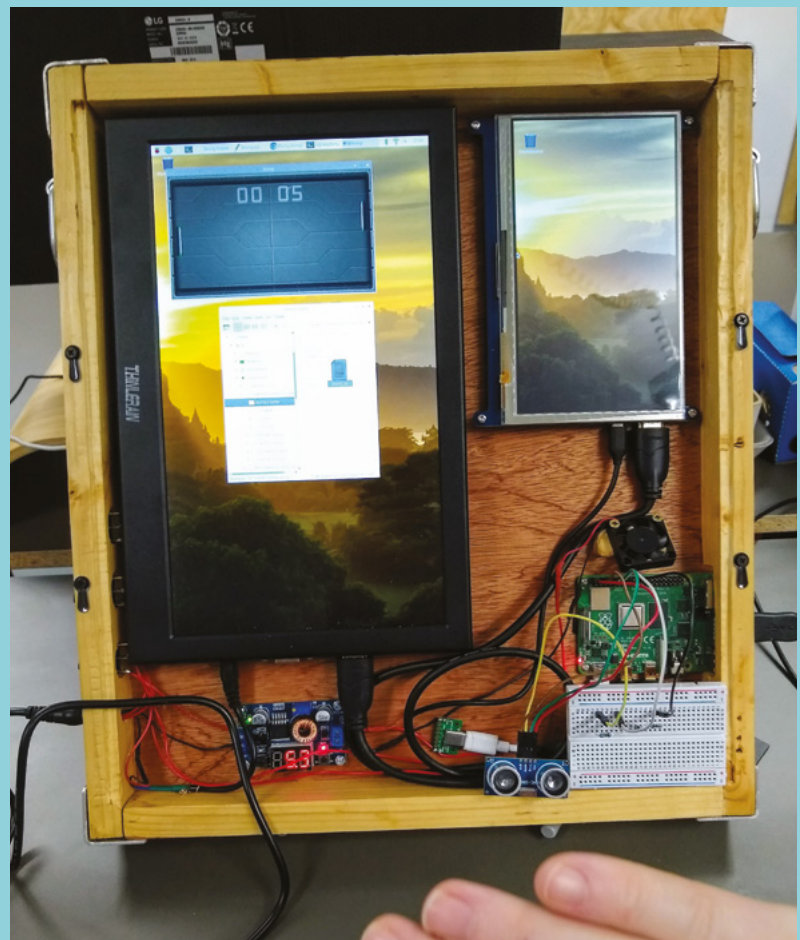

# Adafruit Raspberry Pi B+/Pi 2/Pi 3 Case vs Official Raspberry Pi 3B Case

A DA FRUIT ◆ \$7.95 | [adafruit.com](http://adafruit.com)

R A S P B E R R Y P I ◆ \$7.95 | [pishop.us](http://pishop.us)

**A** dafruit claims that its custom-designed case for Raspberry Pi Model B+ / 2B / 3B is the greatest case for Raspberry Pi, and it may be right. It's made from polycarbonate, which makes the moulded plastic very strong, and it has a great finish. We like the fit and finish of the case, especially the satisfying snap of a Raspberry Pi as you secure it into the case.

There is space in this case for a low-profile HAT, and every port of your Raspberry Pi is accessible through an opening in the base or top piece. The cases are available in a variety of colours, although this author prefers the smoke-grey base with the clear top as it makes prototyping and the tracing of wires easy. But if a bright colour is more your style, you can purchase the base and cover separately, allowing for many colour combinations.



**Above** ■  
A very well-designed case for your Raspberry Pi

**T**his is the official Raspberry Pi case for Raspberry Pi 3 Model B and B+. It's available both in the classic red and white colour combo, and this sleek-looking all-grey version. There are a lot of nice little details with this case. There are the expected openings in the case for things like HDMI, power, USB, etc. But the designers also added an area for the LEDs to be visible – a nice touch.

We also like the fact that the cover can be taken off and you have access to the top of Raspberry Pi. This allows for quick changes of your circuits. No tools are required as it has a beautifully engineered snap fit. The case also includes four rubber feet, which helps keep it from sliding around while programming and designing your circuits. And if you like this enclosure, they make one for Raspberry Pi 4 and Zero too!



**Below** ■  
Made by the creators of Raspberry Pi

## VERDICT

Adafruit case

A nicely designed and functional case.

9/10

Raspberry Pi case

Designed by Raspberry Pi, it has to be great!

9/10



# Element14 Desktop Enclosure Kit

ADAFRUIT ◆ \$50 | [adafruit.com](https://adafruit.com)

**A**lthough the Element14 Desktop Enclosure Kit does not work with Raspberry Pi 4, it still packs a lot of interesting features. The case is beautifully designed, but what we really like is the included add-on board. This board adds an intelligent on/off power switch and a real-time clock with battery backup. This allows for a very simple start and shutdown sequence. The board also features an mSATA SSD socket, so you can plug in a large external storage drive. That makes creating your own Raspberry Pi-based media server really easy!



## VERDICT

Element14 Desktop Enclosure Kit

A good solution for a DIY media centre.

8/10

# Pibow Coupé 4 – Ninja

PIMORONI ◆ \$9 | [pimoroni.com](https://pimoroni.com)

**C**rafted out of five layers of acrylic, the Pibow Coupé 4 is a simple and elegant solution to enclosing and securing your Raspberry Pi 4. Once you stack and attach the components

to your Raspberry Pi, you'll have easy access to the camera / display ports and GPIO pins, and a safe home for your device. This is a lightweight, affordable, and easy to assemble case for your next project. Pimoroni also sells other Pibow case varieties for older variants of Raspberry Pi.



## VERDICT

Pibow Coupé 4 – Ninja

A perfect complement to Raspberry Pi 4.

10/10

# Pibow Touchscreen Frame

PIMORONI ◆ \$9 | [pimoroni.com](https://pimoroni.com)

**T**he Pibow Touchscreen Frame from Pimoroni isn't a case for your Raspberry Pi, but

we're still going to include it in this list because it serves a lot of the same functions. This stand will keep your

Raspberry Pi off of your desktop, reducing the chance of a short circuit from any stray conductive bits, and it also allows you to easily attach the official 7-inch Raspberry Pi touchscreen to your Raspberry Pi. If you have a touchscreen, and you are working on developing a prototype, this stand is a good choice as it allows for very easy access to all the ports and pins of your Raspberry Pi.



## VERDICT

Pibow Touchscreen Frame

A simple, useful stand for your Raspberry Pi.

7/10

## Armor Case with Dual Fan

PI SHOP ◆ \$13 | pishop.us

**If you need a lot of heat dissipation with your Raspberry Pi project, this case may be a perfect fit for your next build.**

Although not a true protective case, because much of your Raspberry Pi is still exposed, this aluminium enclosure offers a lot of protection from heat. If your project runs a lot of intensive code, then the large aluminium heatsink, coupled with two fans, will keep your Raspberry Pi running cool. Just keep in mind those heatsinks are conductive – you don't want any of your circuits touching it and causing a short.

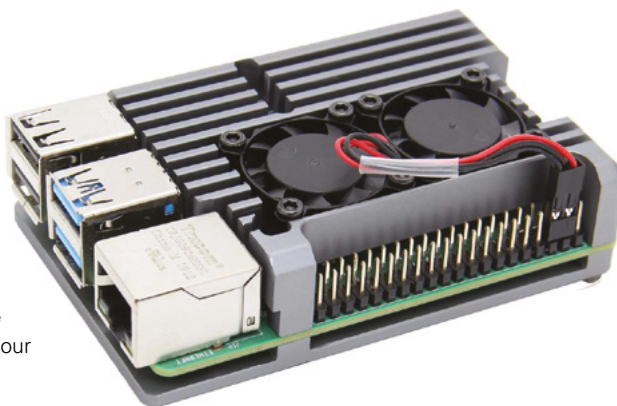

### VERDICT

Armor Case with Dual Fan

Very effective in cooling down your Raspberry Pi 4.

8/10

## Adafruit Raspberry Pi Zero Case

ADAFRUIT ◆ \$4.75 | adafruit.com

**The Adafruit Raspberry Pi Zero case is a beautifully designed, polycarbonate**

**case that fits the classic Raspberry Pi Zero and Zero W.** It allows for access to everything you need on your Raspberry Pi Zero in a minimalistic and sleek format. The case snaps together quickly so you can get to building your circuit in a matter of seconds. If you need access to the GPIO pins, simply snap off the area above them and get to building. Don't let your next project get shorted out because you didn't have a proper case.

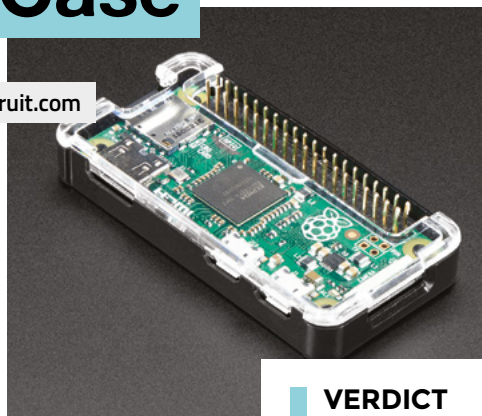

### VERDICT

Adafruit Raspberry Pi Zero Case

A great case for Raspberry Pi Zero.

10/10

## Premium Raspberry Pi Zero Case

PI HUT ◆ \$6.39 | thepihut.com

**This well-designed case for Raspberry Pi Zero has many great features.** The case is constructed of three individual components, all of which clip together easily, offering complete protection. If

you need access to the GPIO pins, you can simply snap off the L-shaped piece of plastic on the top of the case and get building. A unique feature is the separate cover for the SD card slot. It's nice to be able to get easy access to the card, yet also have it protected when in use.

### VERDICT

Premium Raspberry Pi Zero Case

Fun and functional.

10/10





# Aluminium Heatsink Case

PIMORONI  \$12.80 | [pimoroni.com](http://pimoroni.com)

**A**re you running some cutting-edge code on your Raspberry Pi computer? Or maybe just crunching a lot of data? Well, then you know Raspberry Pi boards can run a little hot, especially Raspberry Pi 4 – although recent Raspbian firmware updates have improved matters. This case takes care of the issue by being a huge passive heatsink. The creators claim Raspberry Pi 4 will give you 10–15°C of passive cooling under full CPU load. It's also a large piece of aluminium that will offer some decent protection too.

One thing to note about this beautiful case: it's made of metal, and metal conducts. If you are planning on adding a bunch of external components,

you most likely will want to get those parts away from the actual case using something like a Pi Cobbler or other means. That could be a big negative in some situations, but we see so many Raspberry Pi projects that are all code-based, and that makes this a perfect case for those types of projects. We'll also mention that this case is not only functional, but absolutely beautiful. And it comes in a variety of anodised colours.

## VERDICT

Aluminium Heatsink Case

Passive and elegant.

8/10

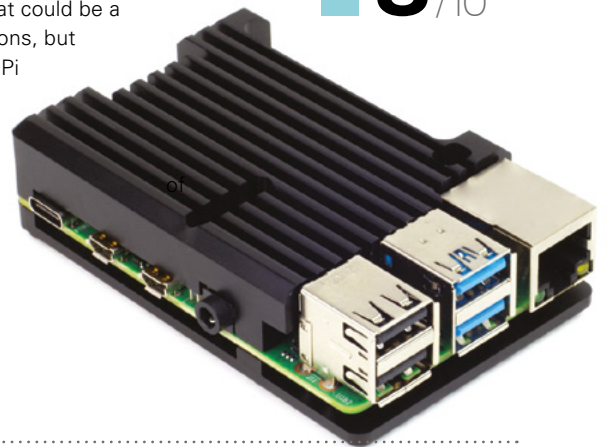

# SmartiPi Touch 2

SMARTIPI  \$28 | [sparkfun.com](http://sparkfun.com)

**T**he SmartiPi Touch 2 is designed to complement the official Raspberry Pi 7" Touchscreen LCD, along with housing your Raspberry Pi 2, 3, B+, A+ or 4 on the

back. The stand has a pivoting base, allowing for viewing angle adjustment, and also has a variety of mounting holes if you need a more permanent installation.

In addition to the enclosure, this kit includes a built-in fan for cooling your Raspberry Pi, along with a dual micro USB splitter cable that allows you to power the display and Raspberry Pi at the same time, which is really convenient. If you are looking for a mini touchscreen Raspberry Pi-based computer for your next project, this enclosure will make it a lot easier to build. □



## VERDICT

SmartiPi Touch 2

Good case for a touchscreen-based computer.

9/10

# ASSEMBLED PI COBBLER

ADAFRUIT  \$7 | [adafruit.com](http://adafruit.com)

The Adafruit Pi Cobbler, along with the supplied cable, allows you to easily hook up a breadboard to the pins of your Raspberry Pi. Simply plug one end of the cable into Raspberry Pi, and the other into the Cobbler. Next, plug the Cobbler into a breadboard and start wiring up your circuit. This is a great solution for prototyping/adding components outside of your Raspberry Pi enclosure, especially if the latter is made of metal!

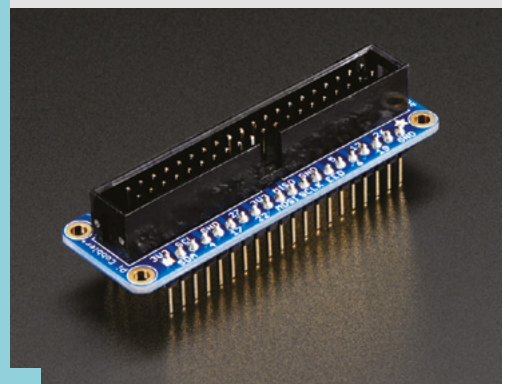

# GET STARTED

WITH

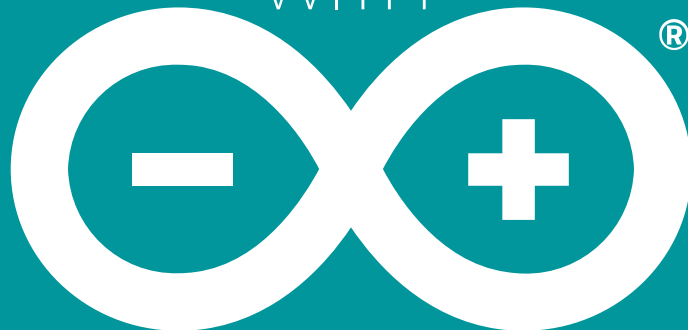

# ARDUINO

Robots, musical instruments,  
smart displays and more



## Inside:

- Build a four-legged walking robot
- Create a Tetris-inspired clock
- Grow veg with hydroponics
- And much more!



**AVAILABLE  
NOW**

[hsmag.cc/store](http://hsmag.cc/store)

plus all good newsagents and:

WHSmith

BARNES & NOBLE



Available on the  
App Store



GET IT ON  
Google Play

FROM THE MAKERS OF **HackSpace** MAGAZINE



## Can I Hack It?

# An Xbox 360 controller?

How you can reuse a broken games controller



Les Pounder

@biglesp

Les Pounder loves taking things to pieces and seeing how they work. He teaches others how to be makers and tinkerers at events across the UK. He blogs at [bigl.es](http://bigl.es)



### Right

Inside this plain off-white shell are electronics for a custom arcade controller, light-up buttons, and a driving simulator

**T**he Xbox 360 arrived in 2005 to much success. It ushered in a new era of high-quality graphics and 'always on' gaming. The controller was also seen as a major step up from the previous generation, as it provided a standard

USB interface which could be used on PC. The previous Xbox used USB, but it was adapted into a proprietary connection (though eager hackers soon solved that issue). Fast-forward to 2020 and the Xbox 360 has been superseded by the Xbox One, so its accessories can now be found cheaply. So, when we stumbled upon a 'broken' Xbox 360 USB controller, we knew that we had to take it apart and learn more about it.

### GENERAL CONSTRUCTION

The controller is made from a firm, thin plastic that is resistant to sudden impacts. This plastic can be worked with hand tools and a rotary tool, such as a Dremel. The case is held together using seven cross-head screws. The seventh screw is located under a sticker in the centre of the pad. With the

screws removed, we can see the main chassis, which is a series of plastic pillars and struts designed to provide strength and durability, while maximising space inside the controller. Take care as the internal plastic is quite sharp. The coloured buttons for Y, B, X, A and the Xbox logo can be easily removed for cleaning and, with a little soldering and care, LEDs can be placed inside the plastic for a custom controller. The USB cable comes into the controller from the top, and is held in place by the two halves of the case forming around a strain-relief section.

### ELECTRONICS

As this is powered via USB, we know that the controller is running at 5V. The power and control signals ('Data -' and 'Data +') come into the controller via the USB lead at the top of the controller, and go into a white port in the centre of the circuit board. The port does not provide a friction fit; this means that to remove the wires, we have to desolder the

### YOU'LL NEED

Xbox 360 wired USB controller

### COST

£Various

### WHERE

eBay, Amazon, thrift stores

## WHICH VERSION?

There are two versions of the Xbox 360 controller: the wired controller which we tore down in this article, and a wireless version. The only differences between the two is that the wireless version has a battery pack for 2 × AA cells (3V in total) and a wireless chip for communication with the Xbox 360. This chip and connection is proprietary, but there are receivers available for Windows PCs which enable the use of the pad. We can also use the wireless version for a custom wireless arcade controller, so we can sit back on the couch and play Double Dragon, TMNT, or Mortal Kombat in comfort.

But with wireless connections come problems. We need to ensure that we have power and a constant connection. If you are thinking of using an Xbox 360 controller in an arcade build, then go for the USB pad, as it offers a constant and consistent connection with very little work.

connections. For reference, the wires are colour-coded with standard USB colour coding. Red for 5V, white for Data -, green for Data +, and black for GND. Yes, the wiring is standard USB, but with a proprietary breakaway connector between the controller and Xbox 360, but we can hack our own connector instead using a USB breakout connector easily bought online. The circuit board has two JST connections to rumble/feedback motors, which are offset weighted motors that provide feedback when gaming. These motors can be easily removed and used in another project. Inputs on the board are both digital and analogue. The digital inputs are for buttons such as Y, B, X, A and they have two sections per button. One section is pulled high, and the other is connected to GND. When the button is pressed, it forces a carbon-tipped rubber shaft to bridge the two connections and pull the

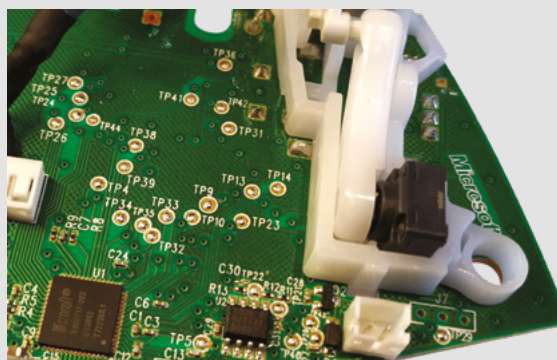

high side low, causing the game to register a button press. The analogue inputs are in the form of two analogue joysticks which output a value to the custom microcontroller that the game uses for fine control. The analogue sticks also have a momentary switch which is used when pressing the stick down into the case. The two triggers use potentiometers and a spring to provide fine control and a method to reset after being pressed. When taking the triggers apart, do take your time and marvel at how clever the series of pivots work to provide a smooth response.

Around the board, there are a number of test points (TP) we can use to tap into the signals being sent from the inputs, and to make a good connection to GND.

## HACKABILITY

This is so hackable! We have clear access to everything on this board. Firstly, we can add LEDs to the buttons by tapping into the 5V connection with a little wire – don't forget the resistors! We can also connect our own controls to the digital inputs and use the Xbox controller circuit board as a donor board for USB input. So, connecting arcade controls is totally possible with a little patience. With some 3D printing, we can create custom driving controls by breaking out the analogue inputs to larger compatible inputs. The motors can be salvaged and used in other projects, such as drawing robots which use vibration to dance around a sheet of paper with crayons attached to their arms.

## CONCLUSION

The Xbox 360 controller is quite old (circa 2005) but it is still a delight to use when gaming, and now we have a hackable controller which can be repurposed into much grander projects. It isn't worth picking one up for the full retail price, but if you can find one in a thrift store or car boot sale, then it is worth your time and effort to use this in a fun project. Happy Hacking! □

### Above

The two triggers are genius. They provide precise analogue input via a potentiometer, and this is held in place using a custom plastic mechanism and a spring

### Left

Detachable motors clear access to the inputs, and a series of handy test points means that we can truly hack this controller into something wonderful

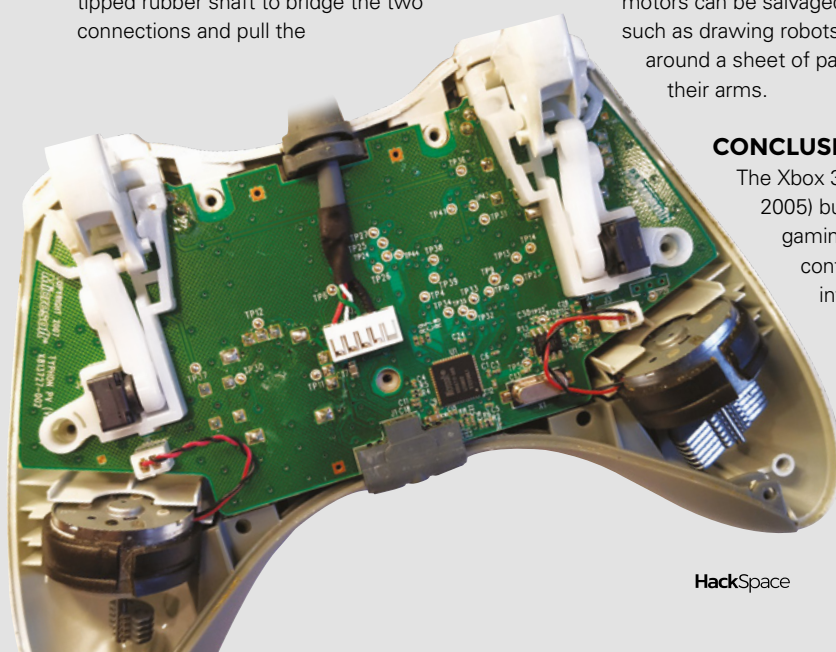



# Pimoroni Fan SHIM

A breath of fresh air for your Raspberry Pi

PIMORONI  £9.60 | [shop.pimoroni.com](https://shop.pimoroni.com)

By Jo Hinchliffe

 @concreted0g



It's a much-discussed fact that the Raspberry Pi 4 is a great performer, but if you push your little computer to the limit, it gets a bit hot. Many Raspberry Pi 4 users have added fans to their systems, coming up with all manner of DIY mounts. However, Pimoroni offer a very elegant-looking solution off the shelf: the 'Fan SHIM'.

The Fan SHIM kit includes a clever way to non-permanently but securely mount the fan, without any soldering. Pimoroni have also developed a software library which offers some simple ways to automate fan control settings as well as providing a platform for if you want to tinker with the settings more deeply.

We ordered a Fan SHIM which arrived very quickly and came well-packed in a nice branded box. Inside the box, the Fan SHIM is a tiny, thin PCB – the fan is a separate item. The fan is wired to a small JST connector, with the wires neatly protected with heat-shrink tubing. You'll also find a small bag containing some nylon nuts and bolts, plus the obligatory spare set for when you lose one in your carpet.

There are some instructions on the Pimoroni website about how to assemble the Fan SHIM, but it's simple enough. Two bolts are inserted up through the PCB, and a nut is tightened down on them to act as a spacer to lift the fan slightly off the PCB. Then the fan is fitted with the wires facing the lower side of the Fan SHIM. Two nuts are then run down on top of the remaining bolt thread to clamp the fan in place. Noting the orientation of the wires the JST is connected to is quite fiddly, but in the end, we did this with a pair of tweezers as it's such a small connector.

The Fan SHIM can now be fitted to Raspberry Pi 4; it uses a friction fit over the Raspberry Pi's header pins to hold it in place, so requires no soldering. Powering on the Raspberry Pi and without making any changes or installing anything, the fan starts running straight away. It was good to note that it was very quiet, barely perceivable at all.

Of course, we might not want the fan to be on all the time, so setting it up to automatically turn on and off at certain temperatures, akin to a regular laptop computer fan, was our next step. The team at Pimoroni have written a small Python library for fan control, and again the instructions online give you an

**// If you're doing some serious number crunching, the Fan SHIM is a good cooling option //**

easy-to-follow guide to installing and configuring the settings using the terminal app in Raspbian.

In the library example to automate the fan, the user can change the thresholds of what temperature the fan turns on, turns off, and how often it checks the temperature. It's also set up to use the on-board

**Above**   
The Fan SHIM kit arrives nicely packaged from Pimoroni

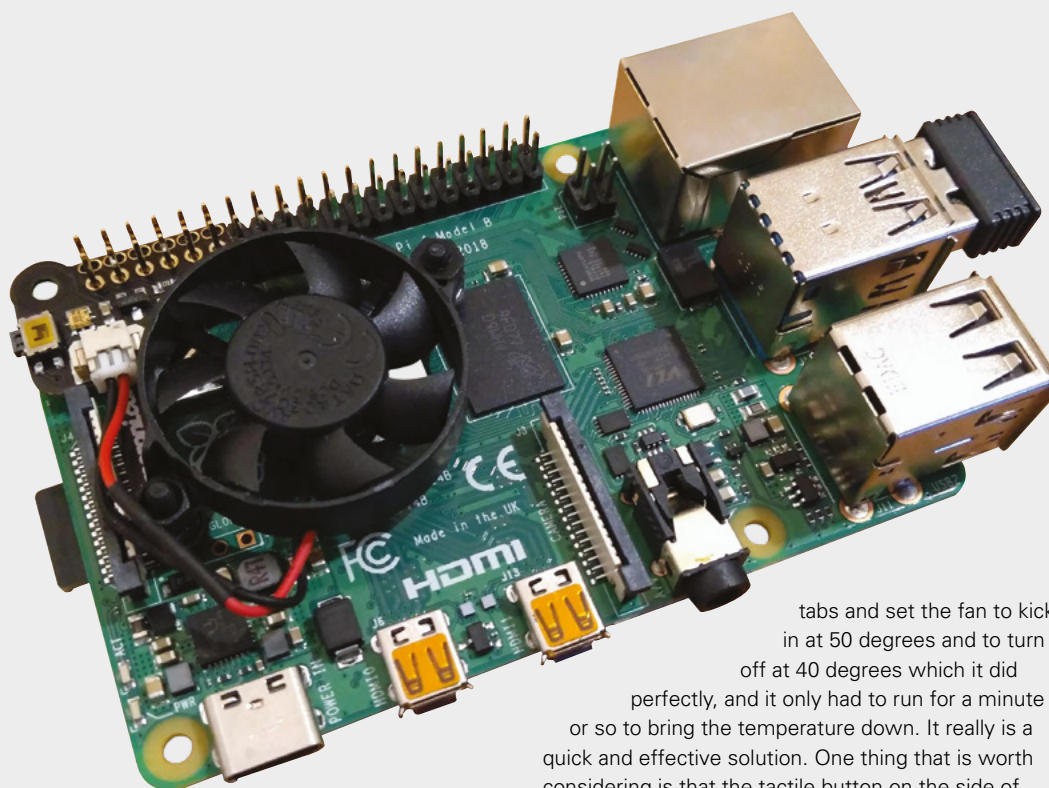

**Left** ♦ It's a simple couple of bolts and a few nuts to assemble the kit in a few minutes

**Below** ▣ The kit fits onto Raspberry Pi 4 header pins and is a friction fit, so there's no need for soldering. You can also get a header extension kit to allow you to use other devices on the header pins

**Below** ♦ The kit consists of a small PCB and a good-quality and quiet 30 mm fan

tabs and set the fan to kick in at 50 degrees and to turn off at 40 degrees which it did perfectly, and it only had to run for a minute or so to bring the temperature down. It really is a quick and effective solution. One thing that is worth considering is that the tactile button on the side of the Fan SHIM protrudes the edge of the Raspberry Pi footprint. While this is accommodated for in Pimoroni cases for Raspberry Pi 4, we have an aluminium case from another vendor which doesn't have space for the button (yet – we have our rotary tool primed and ready).

With the latest firmware, Raspberry Pi 4 doesn't overheat unless it's under heavy load, but if you're doing some serious number crunching, the Fan SHIM is a good cooling option that doesn't take up too much space. ▣

LED to give visual feedback, from green to red, to indicate the temperature of the computer. You can also, using the example given, use the button on the side of the Fan SHIM to manually override the automated settings and turn the fan on and off. If you find an automatic set of settings you like, they will persist, and the Raspberry Pi will start the service on subsequent boot ups.

We found the fan to be effective as well. We set a load of YouTube videos running in numerous browser

## VERDICT

A small, elegant solution to Raspberry Pi 4 cooling.

9/10

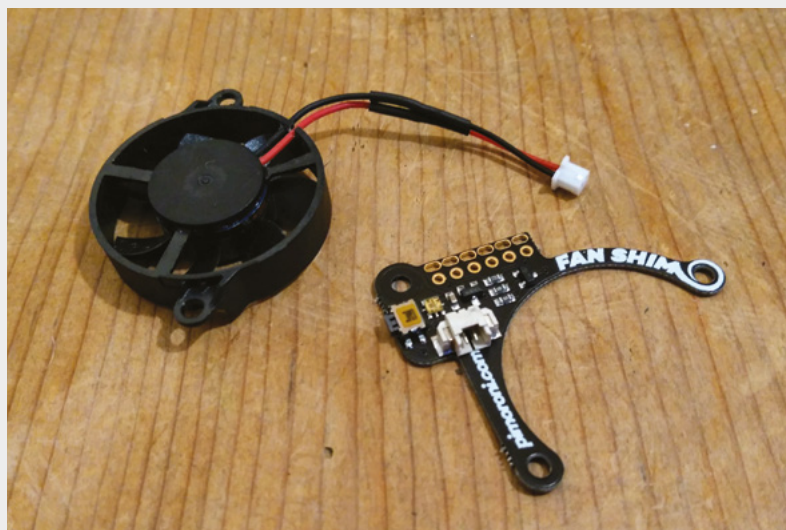
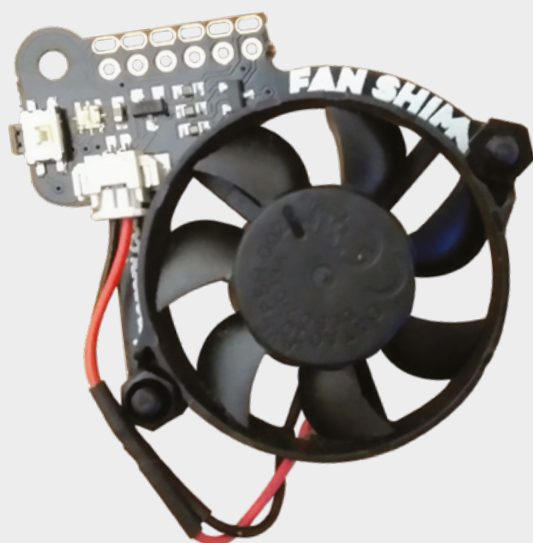



# Kitronik :MOVE mini MK2 robot kit

Take your first steps – er, revolutions – in robotics

KITRONIK ♦ £27.54 | [kitronik.co.uk](http://kitronik.co.uk)

By Jo Hinchliffe

 @concreted0g

**Right** ♦

The completed :MOVE mini MK2 is a cheerful and cool-looking little robot, in our opinion!

**Below** ♦

Unpacking the kit reveals that all components are packed well, with the PCB in anti-static, and other components bagged or bubble-wrapped

**T**he Kitronik :MOVE mini MK2 kit is a small two-wheeled robot that is controlled by a micro:bit, available

separately. It arrives well packed in a neat box, with a small instruction manual which covers both the building of the kit and some initial programming of the micro:bit. The kit contains a PCB board called the 'servo:lite' to which you clamp a micro:bit using a spacer bar and five small machine

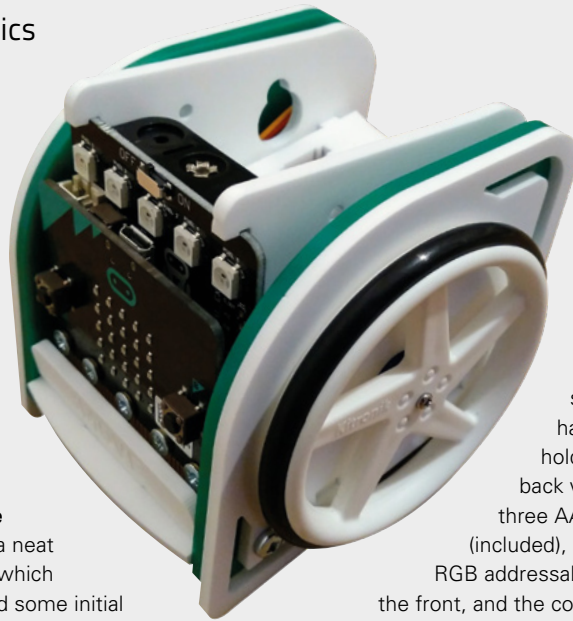

screws. The servo board has a battery holder on the back which takes three AAA batteries (included), and has five RGB addressable LEDs on the front, and the connections for servos on the back.

The first part of the instruction manual guides you through connecting a micro:bit to the servo board, and then programming the micro:bit with some simple examples to control the LEDs. We liked this aspect, as it not only confirms that the boards are connected correctly, but acts as a nice gentle introduction for people appreciating, that this might be the first time they have programmed a micro:bit, or programmed at all.

Following that, the next phase of the build is to assemble the wheels onto the continuous rotation servos and calibrate them. Continuous rotation servos are, as the name suggests, different from regular servos in that they are made to be able to continually rotate in either direction rather than through a fixed amount and therefore are great for making controllable wheels. The instructions take us through connecting the servos and flashing some code to the micro:bit that sets the wheels to turn in different directions and stop using the A and B buttons. There is a trimmer which needs tweaking while running the servos to ensure they are calibrated correctly, and stop when they are required to stop. This is pretty straightforward and clearly explained,



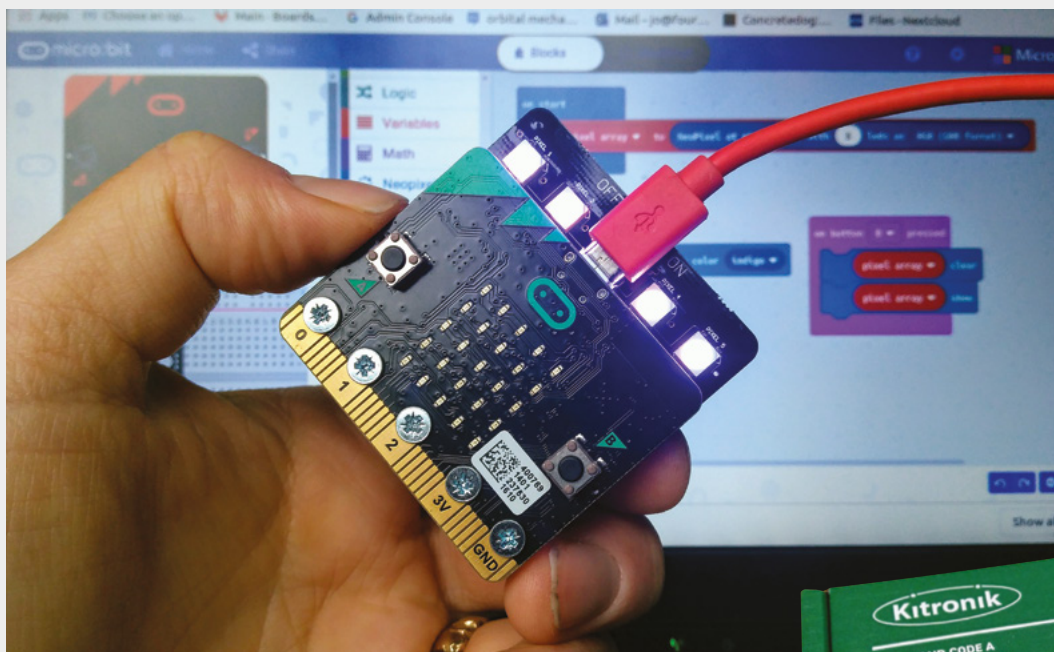

**Left** ♦ We like how the build instructions get you programming throughout the build. Here, we are testing the board is connected correctly, and learning how to program the RGB LED lights

**Below** ♦ The kit arrives in a well-presented box



**Left** □ Assembly is straightforward, with a few steps being a little fiddly

with one small exception in the instructions: when in the online MakeCode programming environment, the blocks for controlling servos are listed under the 'pins' section, which took us a while to discover, having not used servos on the micro:bit before.

Once the servos are calibrated, the instructions move on to building up the chassis, which is accurately laser-cut out of green and white plastics.

“ Once the servos are calibrated, the instructions move on to building up the chassis ”

Everything fits together perfectly, and it uses the technique of nuts being captured in laser-cut spaces for bolts to thread into. This creates nice accurate joints in the chassis, but it can be quite fiddly to get the nuts held in place while holding loose components in the right position. We found using a small piece of masking tape to help keep the

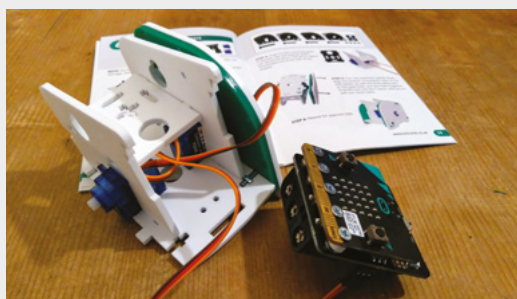

inserted nut in place can act as a very useful third hand. As we assembled the chassis, we realised that there are mounting points and holes in the chassis that aren't utilised. One set of

holes align and allow a pen or pencil to be inserted all the way through the robot to the floor below, and this means you can play at programming the :MOVE mini to draw shapes. Other holes and mount points are there for use by a range of additional add-on kits that can be bought to expand the robot's capabilities. These include things like a bulldozer attachment with a lifting shovel; there are also sensor add-on kits to turn the robot into a line follower and more.

Having finished the assembly of the :MOVE mini, it feels pretty sturdy in hand and our unit worked well, with the calibration of the servos being accurate so that both wheels turned at the same rate, meaning it would travel in a straight line when instructed to do so. While this is definitely a robot for smooth surfaces and not an 'off-roader', it worked well on a smooth carpet, lino, and wooden floors. At the end of the instruction manual, there are links and a QR code to take you to more example code and applications for the robot. Next on our list is to use another micro:bit as a radio control unit so we can drive it remotely, but it's nice to see that there are lots of examples online of things people have done with theirs. □

**VERDICT**  
A great kit, suitable for beginners to both robotics and programming micro:bits. Younger builders might need a little help with assembly, but it's a great-quality kit.

8/10



# Mini Trooper

A fighting robot kit to build at home

**TOTEM** ♦ €59 for one, €109 for two | [totemaker.net](http://totemaker.net)

By Ben Everard

[@ben\\_everard](https://twitter.com/ben_everard)

**T**he Totem system consists of a range of plastic shapes that can be secured together with nuts and bolts. The most common of these plastic shapes are bars, similar in design to aluminium extrusions, which have a groove for holding a nut in place while you slot the bolt through from the other side. There are also some shapes of metal bracket and plastic sheet that you can bolt together to make a whole range of things. In the case of Mini Troopers, you create two fighting robots with 'flipper' weapons.

**Below** ♦  
Let's get ready  
to rumble!

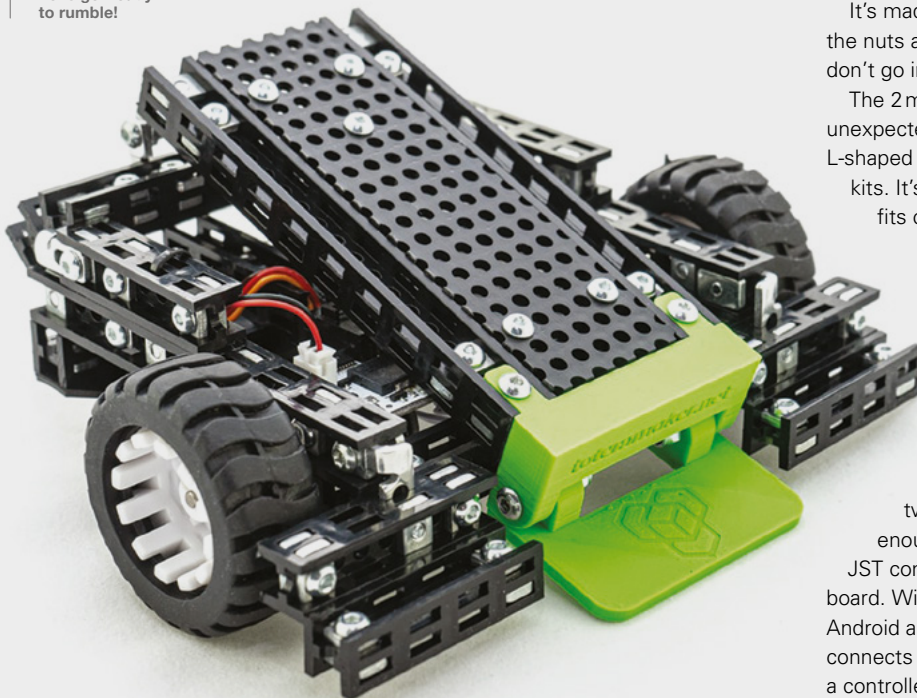

Assembling the robots isn't difficult, but it is very fiddly. Some of the parts look very similar to each other, and some of them take a bit of a shove to get into position. You have to pay close attention to the instructions – even then, we found ourselves having to go back and redo bits. The saving grace here is that the instructions are well illustrated, so we were able to figure out what should be going on.

We'd recommend allowing three hours or so to build each bot. We were able to do the second one a little quicker, but it's not a process you're ever likely to get done quickly.

It's made a little frustrating by the fact that some of the nuts aren't properly threaded, meaning that bolts don't go in properly.

The 2mm hex driver that comes with the kit is an unexpected delight. It's far superior to the regular L-shaped Allen keys that are usually provided with kits. It's magnetic, to hold the bolts in place, and fits comfortably in the hand. Unfortunately, it only comes with a 2mm bit, as we'd like to use it for far more than just the Totem kits, but we can't really blame them for that as it does all the bolts in the kit (there are also a few screws, and a tiny screwdriver is included).

As well as the mechanical parts, there are electrics which, in this case, consist of a control board, a servo, and two motors. These all bolt in place easily enough, and wiring simply involves putting JST connections into the right slots on the control board. With everything connected, there's an app for Android and iOS (we tested the Android version) that connects via Bluetooth and turns your phone into a controller.

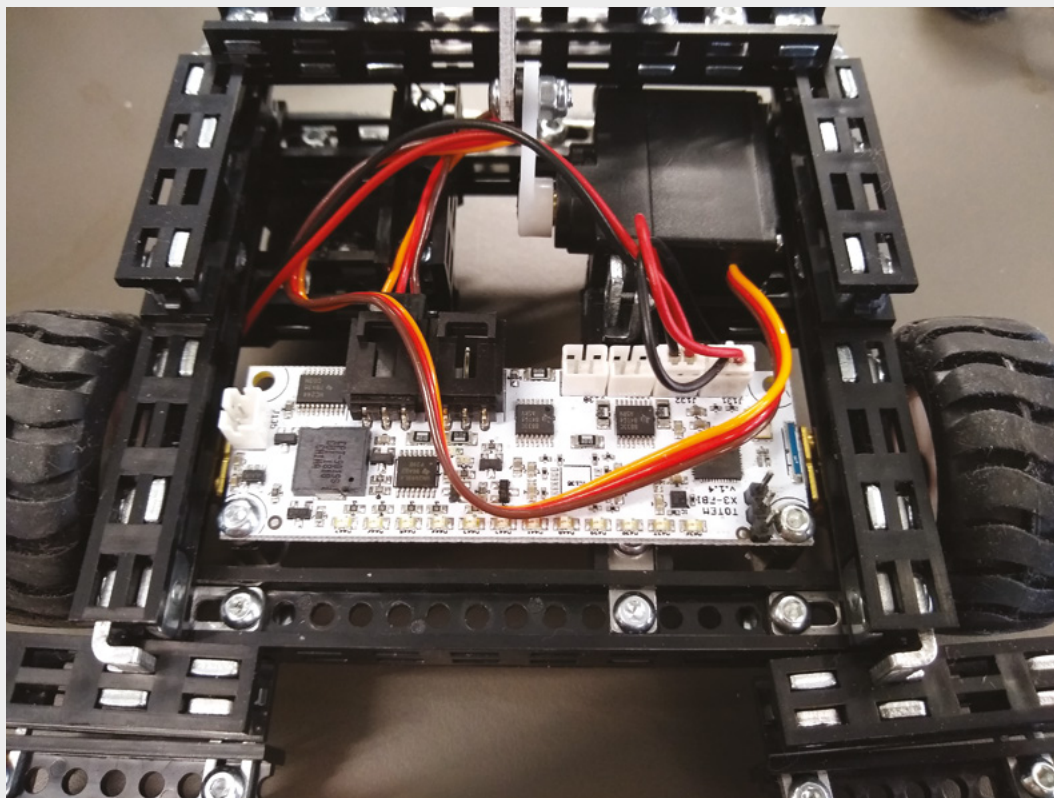

**Left**  The Bluetooth-controlled board at the heart of this robot can be reused in other robots

**Below**  The nut and bolt construction is solid, but can be hard to get into place

Aside from an electrical problem (see below), the ease of getting the electronics working came as a welcome relief to the fiddliness of the mechanical parts.

### NOT PLAIN SAILING

The main problem with the electronics is that the board sits just above the motors, and the battery connection has a habit of shorting out on the metal casing of the motor. This produces a strange, intermittent error when pushing the battery in – which, as there’s no on/off switch or on-board charging, you have to do quite often. We skirted this issue by jamming a bit of plastic under the board, but this is a less than ideal situation.

We spoke with Totem about this and the issue with some nuts not being fully threaded. They are aware of the problems and are looking at potential solutions. If they can fix these, we’ll revise our review.

There are some expansion options, if you’re willing to spend the time getting to grips with the system of joints and brackets, but there are enough non-standard parts to make this tricky. For example, it’s easy to see how the servo could be used to drive different types of weapons, but the servo mounting isn’t easy to reposition.

The electronics, however, are easier to reuse. You can drive up to four motors and two servos, and the app allows you to build an interface of buttons for

this in different ways. Using this, you can build an intuitive interface for almost any arrangements of these actuators.

You get a lot for your money with the Mini Trooper kit. At the end of it, you’ve got two fighting robots that you can have fun driving around and battling. However, there are enough niggles in the creation to mean that we can’t recommend these to beginners. 

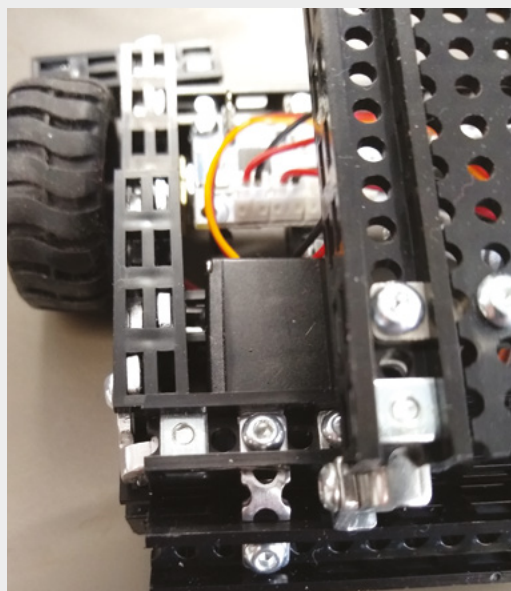

### VERDICT

A fiddly kit with some niggles, but fun to play with and offers some scope for future development.

**7** / 10



next month

issue

#30

ON SALE  
23 APRIL

# ARDUINO

## ALSO

- 3D PRINTING
- ELECTRONICS
- DIGITAL RADIO
- GAMING
- AND MUCH MORE

DON'T MISS OUT

[hsmag.cc/subscribe](http://hsmag.cc/subscribe)

A photograph of a wooden table with a white mug of tea, a stack of brochures, and a hand stirring the tea. The brochures include one titled "Prostate Cancer and you" and another with "CANCER UK" on it. A yellow card in the foreground says "THE BIGGEST KILLER OF MEN". A grey card under the mug says "THE B... MEN I..." and "CALM".

**"1,000,000 cups  
of tea were drunk in  
sheds last year"**

**Charlie Bethel**  
UK Men's Sheds Association





HS