

MAKE | BUILD | HACK | CREATE

HackSpace

TECHNOLOGY IN YOUR HANDS

hsmag.cc

December 2020

Issue #37



**ROB
IVES**

Paper engineering
and the power of
doing your own thing

BUILD A ROBOT

Design and make a perfect
robotic companion

**RASPBERRY PI
400**

We take a look
at the latest
tiny computer

**3D
DESIGN**

Get started
with FreeCAD

CHOOSE YOUR
CONTROLLER

ADD
SENSORS

SELECT
THE PERFECT
MOTORS

PICK YOUR
CHASSIS

**DIY
CONTACTLESS**

Use NFC in your projects

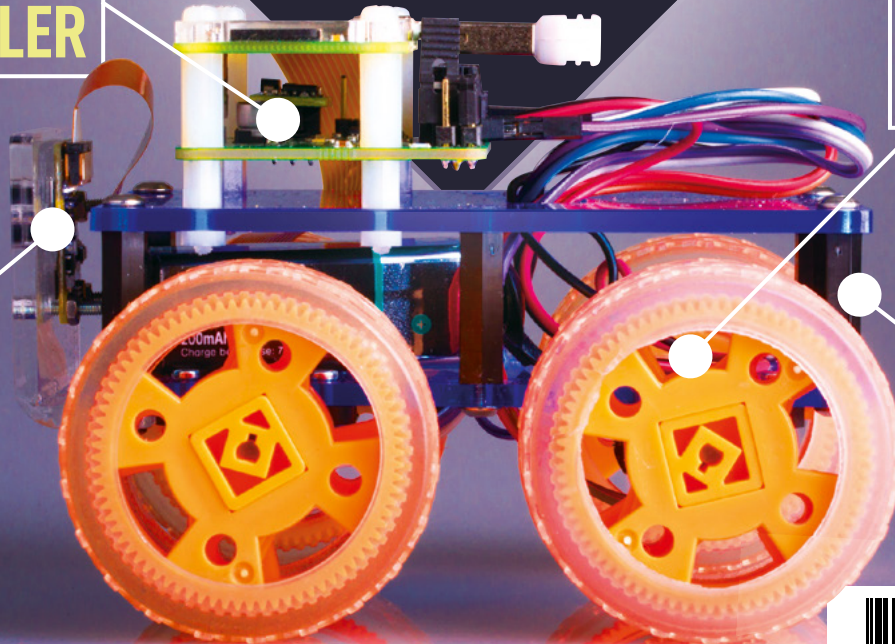

Dec. 2020
Issue #37 £6



RESTORATION HOME AUTOMATION 3D PRINTING MUSIC

9.6 MILLION+ PRODUCTS ONLINE | 1,200+ INDUSTRY-LEADING SUPPLIERS | 1.9 MILLION+ PRODUCTS IN STOCK



YOU INNOVATE. WE CAN HELP. [DIGIKEY.CO.UK](https://www.digikey.co.uk)



The World's Largest Selection of Electronic Components Available for Immediate Dispatch™

*A shipping charge of £12.00 will be billed on all orders of less than £33.00. A shipping charge of \$18.00 USD will be billed on all orders of less than \$50.00 USD. All orders are shipped via UPS, Federal Express, or DHL for delivery within 1-3 days (dependent on final destination). No handling fees. All prices are in British pound sterling or United States dollar. Digi-Key is a franchised distributor for all supplier partners. New products added daily. Digi-Key and Digi-Key Electronics are registered trademarks of Digi-Key Electronics in the U.S. and other countries. © 2020 Digi-Key Electronics, 701 Brooks Ave. South, Thief River Falls, MN 56701, USA





Welcome to HackSpace magazine

Robots – our electromechanical assistants – can come in all shapes and sizes, from hulking great beasts that do things no human could (such as manoeuvring heavy objects in a factory), to tiny little marvels that do things no human could (such as fit through small gaps). The point of robots is that we can control them to do things we can't (or don't want to) do.

Well, that's not the only point – there's also the fact that robots are fun to make. This issue, we're looking at how to make a wheeled robot – one that can scurry around your house. There are loads of ways of doing this, so we show you how to pick the right parts for your bot. What you do with it is up to you, but here are a few things I don't like doing that I might create a robot for:

- vacuum-cleaning
- mowing the lawn
- robot fighting

OK, that last one is a little different, but it's still a great reason to build a robot. Those are just my ideas. What will you build a robot for?

BEN EVERARD

Editor ben.everard@raspberrypi.org

Got a comment, question, or thought about HackSpace magazine?

get in touch at hsmag.cc/hello

GET IN TOUCH

hackspace@raspberrypi.org

[facebook.com/hackspacemag](#)

[twitter.com/hackspacemag](#)

ONLINE

hsmag.cc



EDITORIAL

Editor

Ben Everard

ben.everard@raspberrypi.org

Features Editor

Andrew Gregory

andrew.gregory@raspberrypi.org

Sub-Editors

David Higgs, Nicola King

DESIGN

Critical Media

criticalmedia.co.uk

Head of Design

Lee Allen

Designers

Sam Ribbits, James Legg,

Ty Logan

Photography

Brian O'Halloran

CONTRIBUTORS

Lucy Rogers, Jo Hinchliffe, Lorraine Underwood, Mayank Sharma, Gareth Branwyn, Matt Bradshaw, Marc de Vinck, PJ Evans, Helen Leigh

PUBLISHING

Publishing Director

Russell Barnes

russell@raspberrypi.org

Advertising

Charlie Milligan

charlotte.milligan@raspberrypi.org

DISTRIBUTION

Seymour Distribution Ltd

2 East Poultry Ave,

London EC1A 9PT

+44 (0)207 429 4000

SUBSCRIPTIONS

Unit 6, The Enterprise Centre,

Kelvin Lane, Manor Royal,

Crawley, West Sussex, RH10 9PE

To subscribe

01293 312189

hsmag.cc/subscribe

Subscription queries

hackspace@subscriptionhelpline.co.uk



This magazine is printed on paper sourced from sustainable forests. The printer operates an environmental management system which has been assessed as conforming to ISO 14001.

HackSpace magazine is published by Raspberry Pi (Trading) Ltd., Maurice Wilkes Building, St. John's Innovation Park, Cowley Road, Cambridge, CB4 0DS. The publisher, editor, and contributors accept no responsibility in respect of any omissions or errors relating to goods, products or services referred to or advertised. Except where otherwise noted, content in this magazine is licensed under a Creative Commons Attribution-NonCommercial-ShareAlike 3.0 Unported (CC BY-NC-SA 3.0). ISSN: 2515-5148.

Contents

06

SPARK

- 06 Top Projects**
Brilliant things made by brilliant people
- 18 Objet 3d'art**
Shake it (automatically) like a Polaroid picture
- 20 Meet the Maker: UNIQ Furniture**
Upcycling done right, by Andrew Smith
- 26 Columns**
A remedy for anti-social media
- 28 Letters**
Music! Robots! Requests!
- 30 Kickstarting**
Where cake meets 3D printing

33

LENS

- 34 Build a robot**
Motors, sensors, actuator
- 48 How I Made: A scrolling face mask**
Combine Covid hygiene with reactive blinkenlights
- 54 Interview: Rob Ives**
On the limitations and possibilities of paper
- 62 Improviser's Toolbox Cardboard**
The best bit of any new toy is the box
- 66 Making a maker business**
Today: an idea. Tomorrow: Omni Consumer Products

74

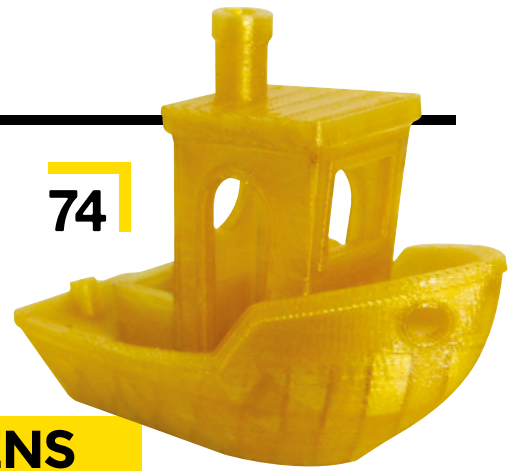

Cover Feature

BUILD A ROBOT

Take control of every single component and build the perfect mechanical companion

34

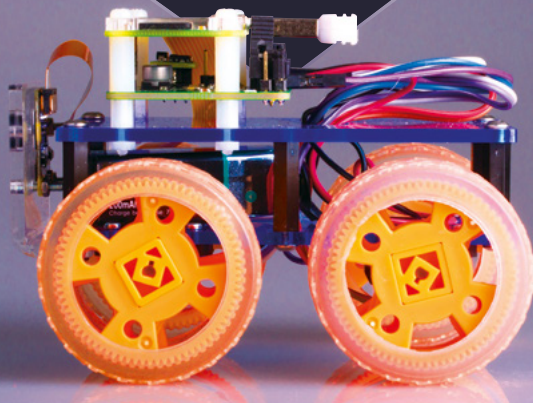

Tutorial

Restoration



72

Bring tools back to life

76

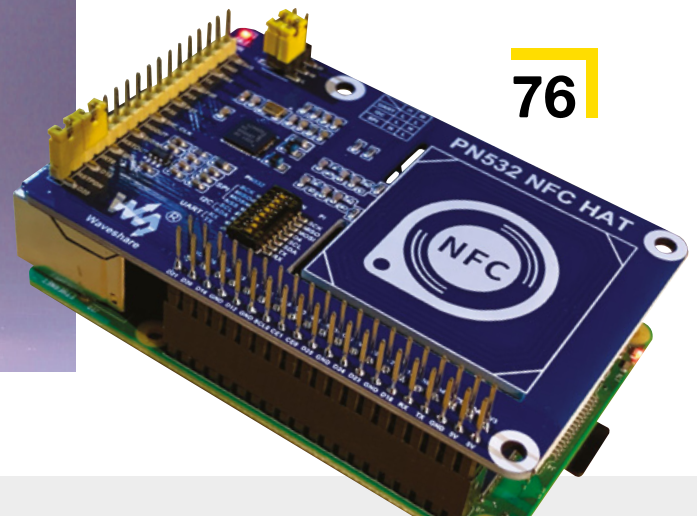

86



Direct from Shenzhen

Belt sander

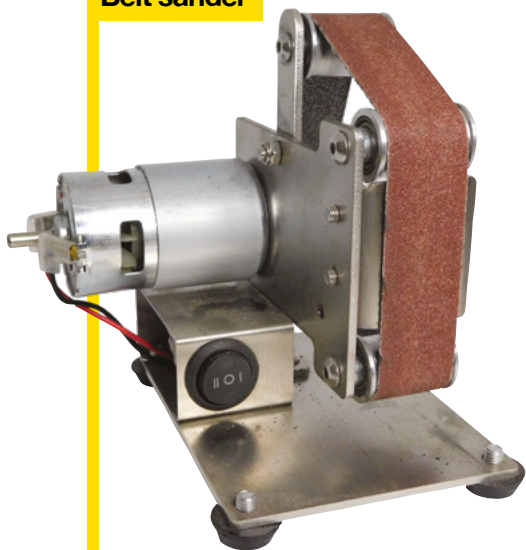

106

Can you get cheap, reliable machine tools from China?

71

FORGE

- 72 **SoM Restoration**
Give new life to old tools
- 74 **SoM Copolyester**
Tough and good-looking printing filament
- 76 **Tutorial Raspberry Pi**
Read RFID and NFC tokens with a HAT
- 78 **Tutorial Home Automation**
Let the machines control your house
- 82 **Tutorial Laser etching**
Adapt a laser cutter to etch into glassware
- 86 **Tutorial FreeCAD**
Customise your wheels
- 92 **Tutorial Found sound**
Find unexpected musical treats everywhere

CONTENTS



110



06

Interview

Rob Ives



54

Teaching the world engineering... using paper

20



99

FIELD TEST

- 100 **Best of Breed Tindie**
Our picks of the maker marketplace
- 106 **Direct from Shenzhen Belt sander**
An essential tool for making knives
- 108 **Review Raspberry Pi Compute Module 4**
A Raspberry Pi for embedded applications
- 110 **Review Raspberry Pi 400**
Our favourite new desktop Linux machine
- 112 **Review NVIDIA Jetson Nano 2GB**
A cheap and accessible platform for AI

Some of the tools and techniques shown in HackSpace Magazine are dangerous unless used with skill, experience and appropriate personal protection equipment. While we attempt to guide the reader, ultimately you are responsible for your own safety and understanding the limits of yourself and your equipment. HackSpace Magazine is intended for an adult audience and some projects may be dangerous for children. Raspberry Pi (Trading) Ltd does not accept responsibility for any injuries, damage to equipment, or costs incurred from projects, tutorials or suggestions in HackSpace Magazine. Laws and regulations covering many of the topics in HackSpace Magazine are different between countries, and are always subject to change. You are responsible for understanding the requirements in your jurisdiction and ensuring that you comply with them. Some manufacturers place limits on the use of their hardware which some projects or suggestions in HackSpace Magazine may go beyond. It is your responsibility to understand the manufacturer's limits.

Ball bearing clock

By Eric Nguyen

hsmag.cc/mCQ1cX

There are many, many ways to interpret the humble seven-segment display. We've seen it in the form of LEDs, VFDs, and mechanical levers that pop in and out of a field of view to simulate lights being turned on and off. Now we've got a new one to add to the list: ball bearings.

This is one of those kinetic builds that only really makes sense once you see the video, but the gist of it is that each of the seven segments in the top part of the clock is either magnetised or not; if magnetised, it picks up a row of ball bearings. Every minute the display portion of the clock rotates downward, ball bearings are removed from, or added to, the display to change the time, and the clock rotates back up with the new time. It's a fiendishly complex design packed with electronics and, almost incredibly, it's maker Eric Nguyen's first Arduino build. →

Right 
The box of Eric's clock is made from plywood and walnut veneer





Back to the Future Clock

By Jérôme Montignies

hsmag.cc/xQbnVP

Great Scott! It's another *Back to the Future*-inspired build. This time, a re-creation of the clock used in the DeLorean to set the time circuits to wherever in time you want to travel to. Jérôme made this version out of 3D-printed parts spray-painted silver for the retro-futurist look, nine seven-segment displays, an Arduino Nano, and a real-time clock. The whole thing looks more complicated than it is, as it's a simple project to put together – or maybe that's just Jérôme's skills making it all look easier than it actually is? →

Right ☑

Someone go back to 2004, and tell me to accept the gift of a ticket to see David Bowie in concert, please

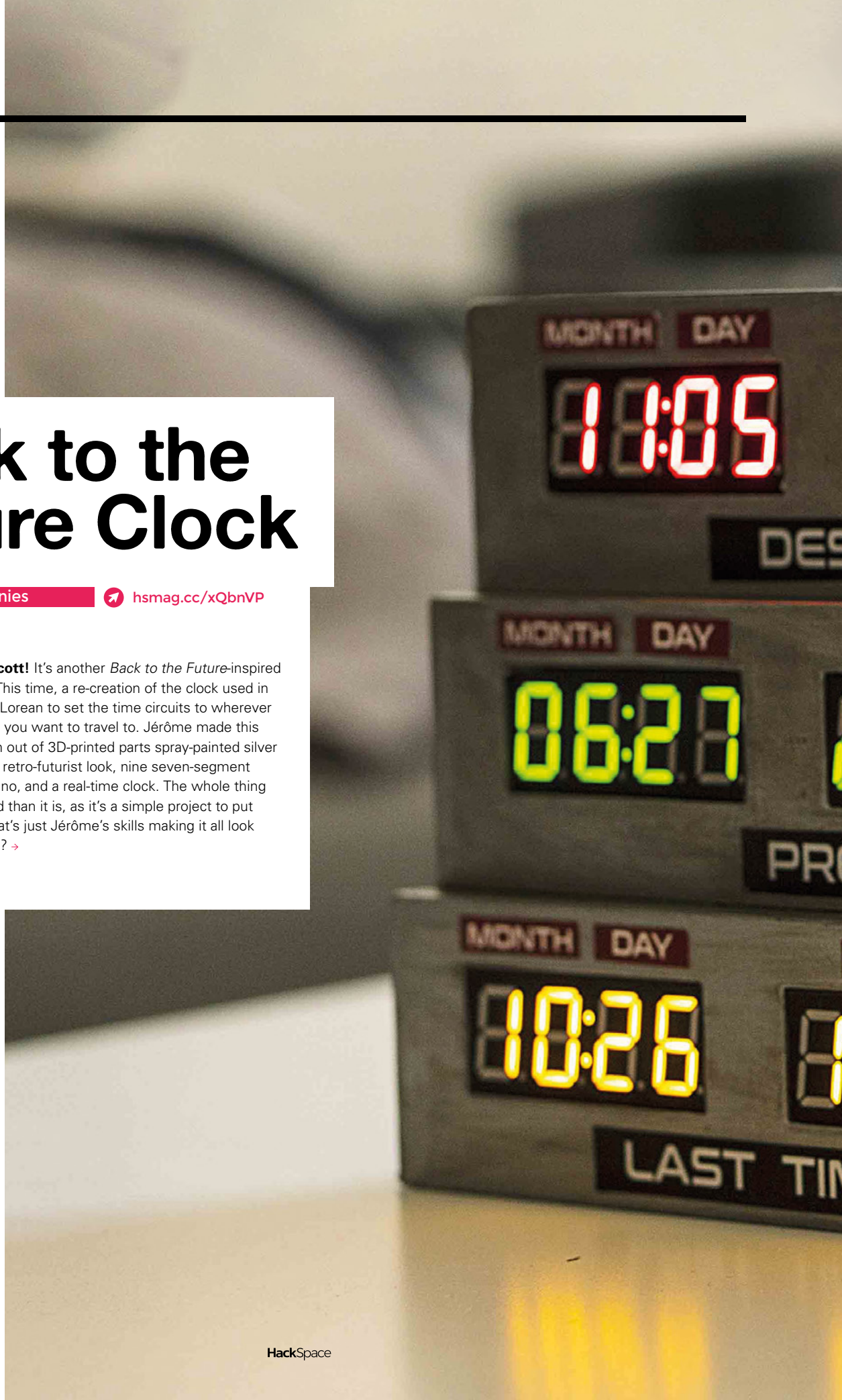

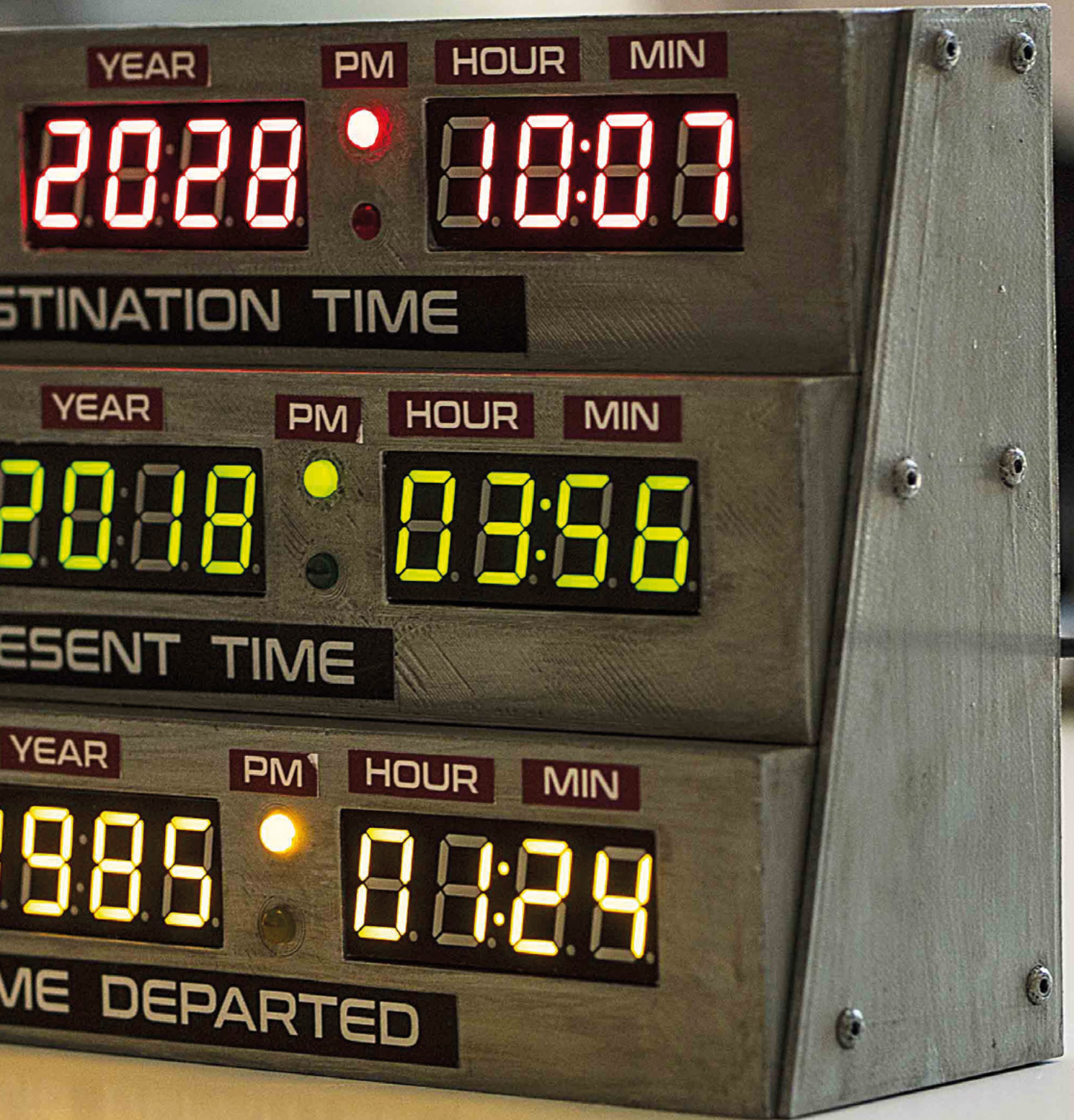

God's clock

By Tauno Erik

taunoerik.art

“I started building electronic circuit sculptures somewhere in September 2019. The main inspiration was then Mohit Bhoite's sculptures on Instagram. You can see a few more of the things I've built here: hsmag.cc/cOnS9z. This project uses two of my favourite components: LEDs and shift registers. And the brain is an ATtiny13 chip.

“The main idea was to use this as a binary counting clock. It counts a 64-bit number, which is very big. And it takes God knows how long a time to reach the finale. So, I decided to call it God's clock.” →



Right ▣
Incredibly, Tauno's only been building circuit sculptures for a little over a year

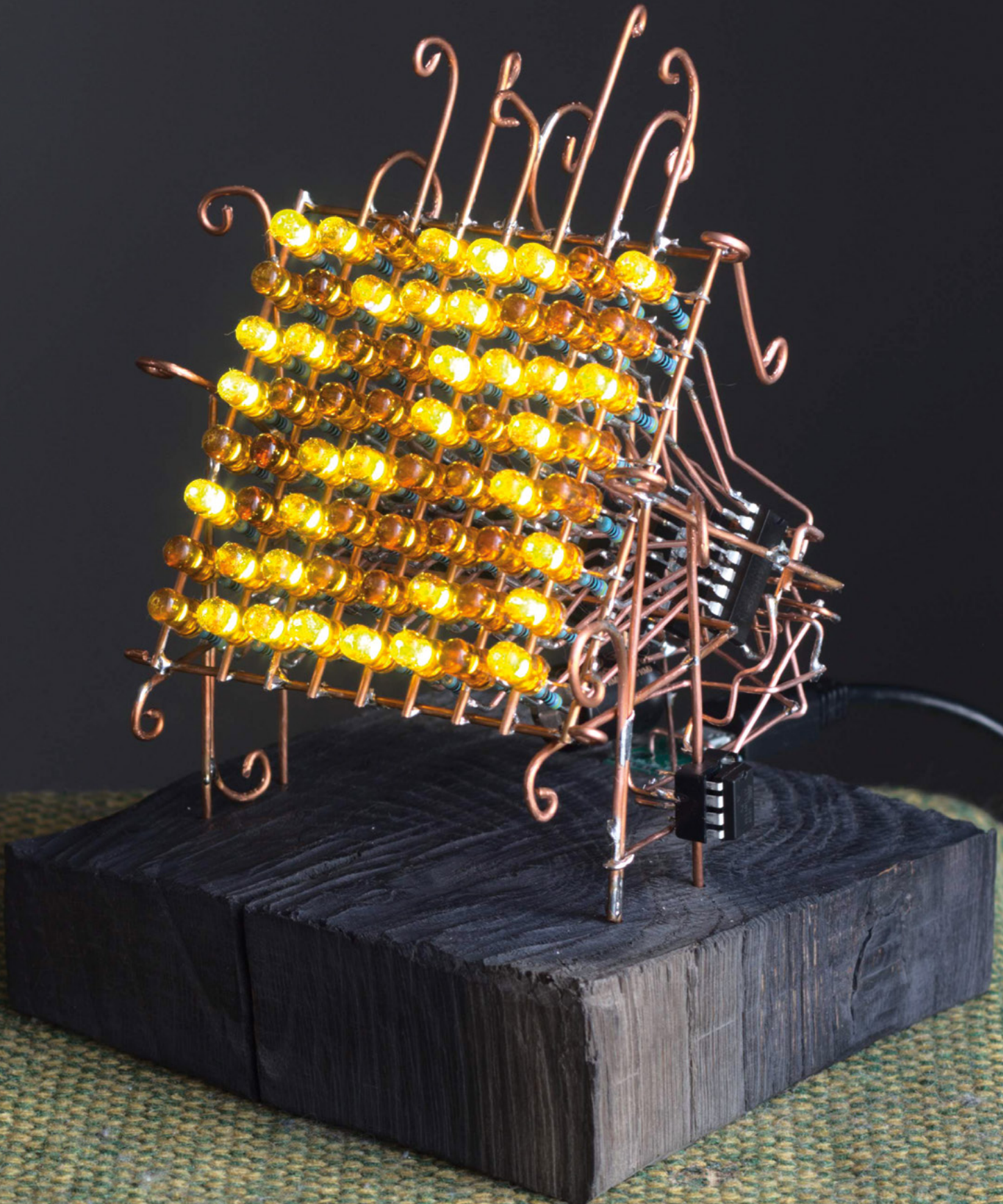



Macro Keypad

By Hayri Uygur

hsmag.cc/AXuMQ2

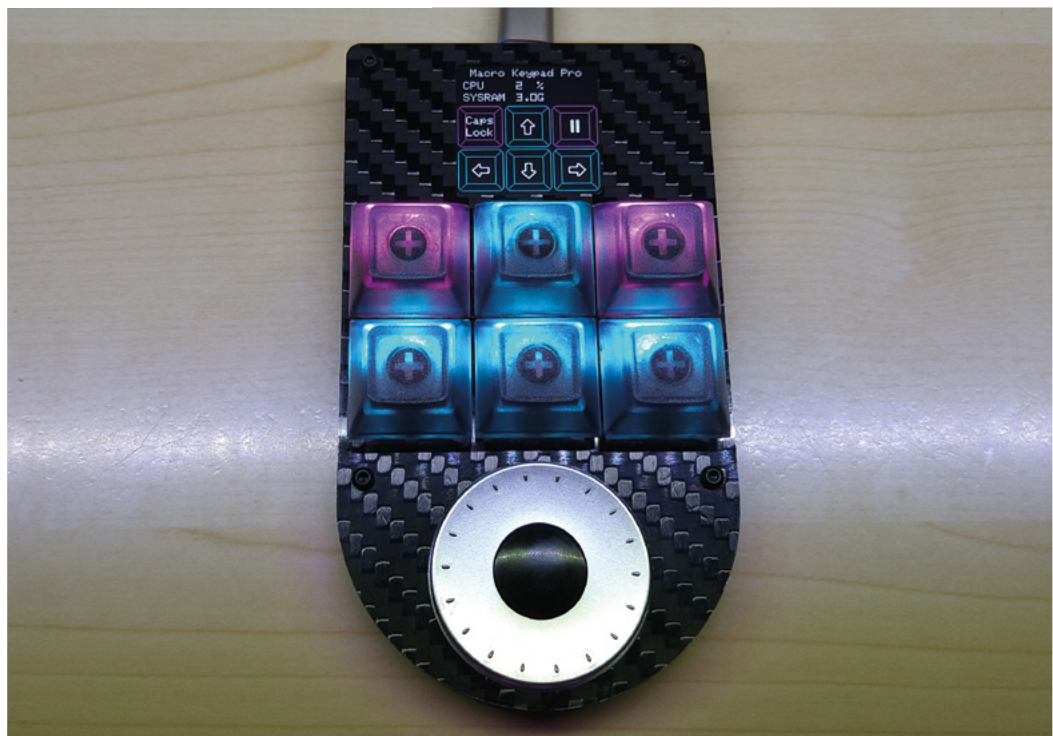
Feast your eyes on the all-new **Macro Keypad Pro**, with rotary encoder and colour display to indicate the key functions. It's based on the ATmega32U4 microchip, as used in the Arduino Leonardo. Hayri made it because he got annoyed by YouTube videos with their changing volume all the time, and wanted to easily add the functionality to control volume, plus the ability to add Arrow, Delete, Home, PrintScreen, and End keys. Though, as the code can be edited in the Arduino IDE and uploaded from there as well, you can map the keys to anything you want, making this potentially extremely useful for specialist applications such as video editing, or (as Hayri does) with EAGLE when designing boards. →



Right  Yes, that is carbon fibre weave. This is a luxury project



Cryptic Auto-Calendar

By Tim Kluessendorf

hsmag.cc/jS1pyw

W

hile clocks use a regular 60 : 60 : 24 format, calendars are forced to adopt a mash-up of Roman ideas whereby the tenth month is named after the number 8, they can't decide whether a month should have 28, 30, or 31 days, and sometimes there's an extra day

thrown in just for fun. That didn't stop Tim Kluessendorf from creating this cryptic perpetual clock.

It's based on a couple of existing designs which Tim has combined: the symbols on the moving parts are obscured, only becoming apparent when the rings move through the viewing windows in the middle of the structure. And the concentric circular design comes from Instructables user tomatoskins' perpetual automatic calendar. Tim has combined the two builds to make an Arduino Nano-powered clock, with a combination of wooden and 3D-printed parts. →

Right ▣

Each ring is driven by its own stepper motor



PCB mask

By Stephen Hawes

stephenhawes.com

This spectacular object was borne out of the question: “can I make origami out of circuit boards?” Two years after Stephen Hawes wondered if it could be done, we have the answer: yes.

The design of the mask is based on Thingiverse user kongorilla's low-poly design from 2012 (hsmag.cc/pkrUmN). To reproduce the design in electronics, Stephen individually milled each plane of the design as a PCB, before assembling them to make a circuit with light-up WS2812B eyes controlled by an ATmega32U4 which is mounted in the mask's forehead. □

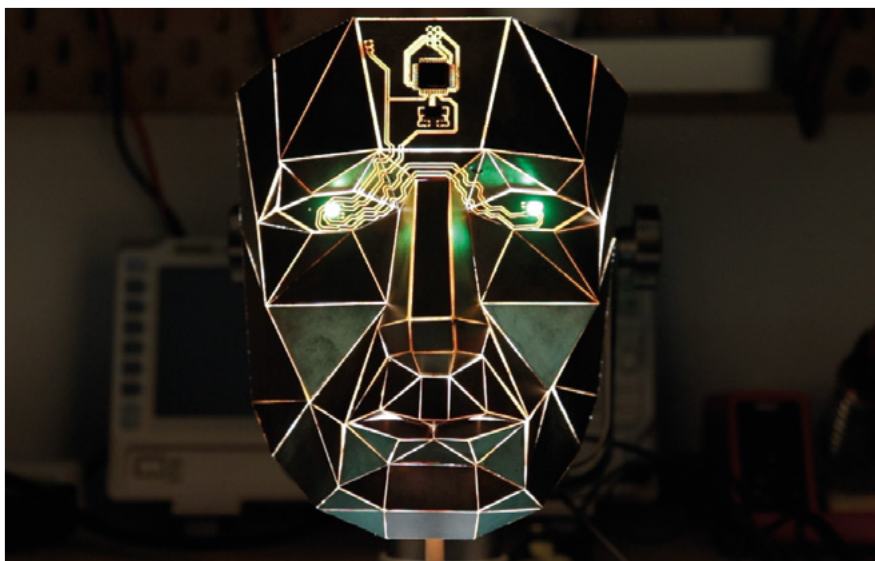
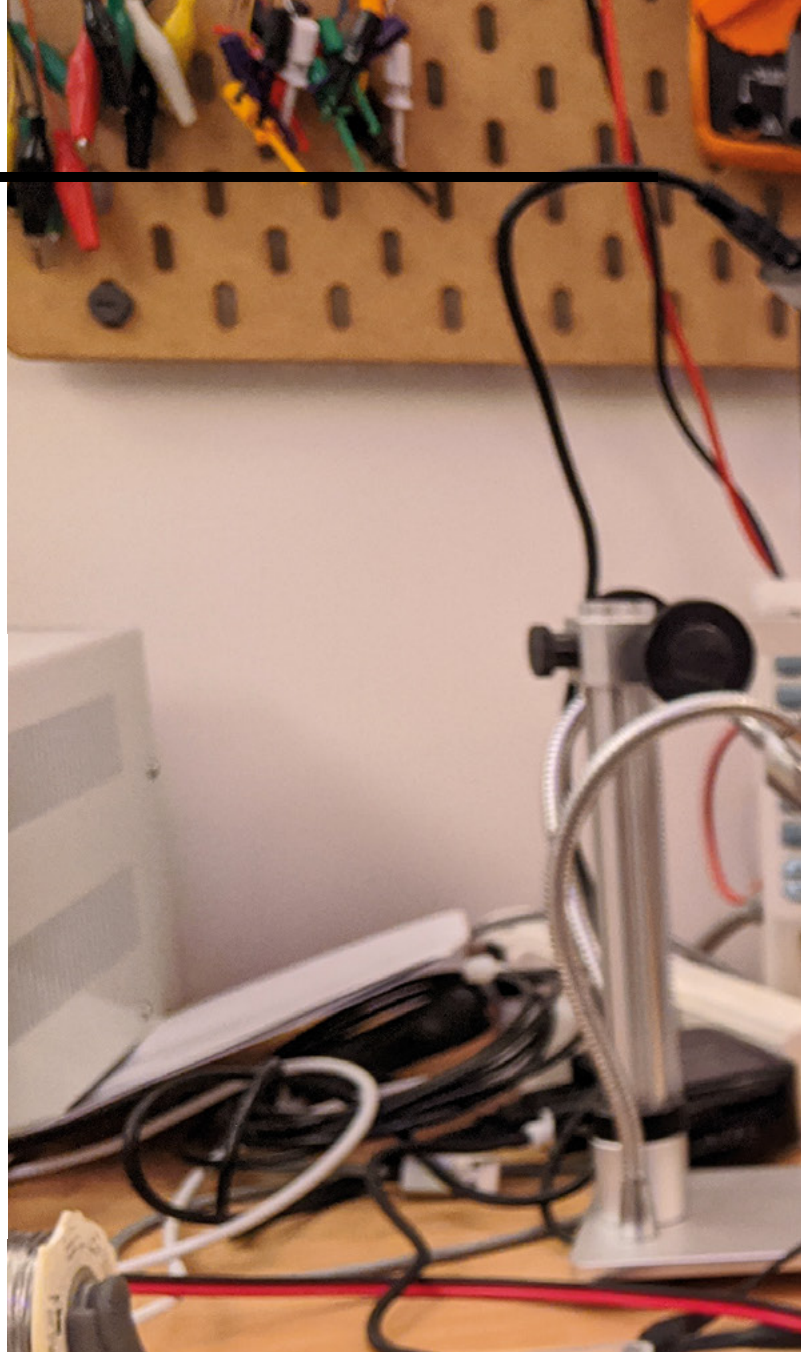

Right □ Power comes up the copper tube mounting the mask to its base



Objet 3d'art

3D-printed artwork to bring more beauty into your life

If painting is art, then shaking the paint pot to achieve an even blend is labour. Like most dumb, physical movement, it can be outsourced to a robot. Why waste ten precious seconds mixing a pot of paint, when you could spend three or four hours printing, building, and testing a machine to do it for you?

It's a ridiculous problem, a problem that doesn't need solving, and Mark Rhodes acknowledges that. But, he says, that doesn't mean it shouldn't be fun to solve anyway. Mark took a 70rpm 12V motor, and printed a simple kinematic mechanism that shakes paint, glitter, or anything else up to an even consistency. It's also pretty mesmerising to watch, something that Mark enhanced in v2 by adding a couple of googly eyes to make it look like an even more robotic Tom Cruise in *Cocktail*. □

➔ hsmag.cc/dhNEwp

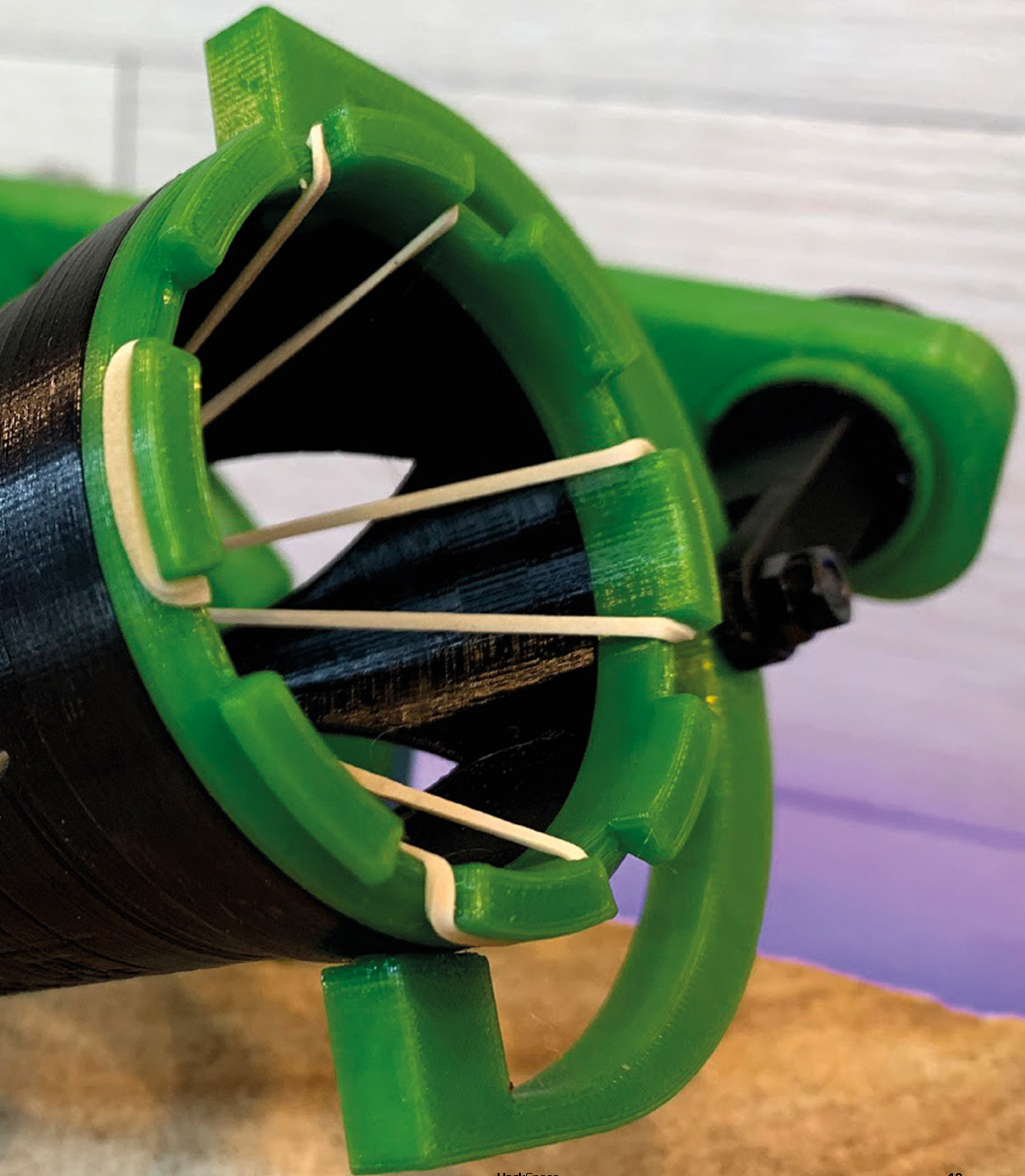

Meet The Maker: Andrew Smith

Everything old is new again



Upcycling is very much enjoying its moment. People love the environment, handmade things, and not throwing decent, solid furniture away that might otherwise have had a second life. We've seen a fair few upcyclers who just give things a lick of paint (and there's nothing wrong with that), but the builds that we're interested in are the ones that turn something old into something new without throwing away the essence of the thing. One of these is Andrew Smith, who operates under the name UNIQ Furniture. We

Below  A sewing machine frame gets a new life as part of a computer desk



spoke to Andrew to find out why upcycling is in, what he's working on right now, and how he got started saving furniture from the scrap-heap.

"I started upcycling after working as a teacher for 28 years in various schools across the country. I was made redundant because there was a funding issue at the school I was at, and unfortunately I was the last in, even though I had been working there for five or six years.

"I'd always had it in mind to start my own business, and being a teacher I got to see a ton of furniture being thrown in a skip every single year. Every summer a big skip arrives, and schools clear furniture and fittings out of classrooms, and fill them with new shiny melamine plastic stuff, and get rid of all the lovely old oak stuff from the 1960s and 1970s which was really well-made. That frustrated me hugely.

"This happened every year, if not termly. If a school decides 'we're going to refurbish this room', or 'we're going to restock the room', spruce it up or whatever, then it's out with the old, in with the new. Schools seem to have budgets that have to be spent within X number of weeks. It gets to the end of the year, they've been saving, saving, saving, and suddenly the local authority says you've got to spend your money before a certain date, otherwise you won't get as much next year; that money will go back in the pot. Generally speaking, schools will just buy desks, or new storage. There's no forward thinking, no planning, it's all a bit spur of the moment very often.

"I thought, let's try and save some of this stuff and put it back into people's homes. →





"I've still got a lot of contacts in schools, so they sometimes call me and say that they're demolishing this or getting rid of that. I had one of my big hits at the school I was made redundant from; they were demolishing the school changing rooms and rebuilding them. The school was built in the 1950s perhaps, so there were loads of lovely big steel changing units, oak benches, hundreds of brass hooks. I got a call to let me know that the demolition team were there and that this stuff was going in a skip, so I jumped in the van and rescued most of it. I

think I had about three or four van loads in the end. That's another industry that doesn't think about reuse at all; it's there to do a job, and that's to demolish. The majority of what they demolish ends up in a skip, regardless of what the value of it is; it's just not taken into account.

QUALITY

"If something was made in the 1950s, 1960s, 1970s even, it was generally made to a much higher standard than it would be these days, because the quality of the materials they used was much better. They'd make school furniture out of oak and mahogany and beech and so on, and they'd use proper joints rather than flat-pack furniture. But

" I'll have a go at most things, but I'm happiest doing upcycling and restoration "



Right Andrew shortened this gym bench from 8 foot down to 4 foot without altering its character



Left ♦
As well as furniture,
Andrew does bespoke
carpentry
commissions

Below ♦
“More taste, less
waste”, is the motto at
Uniq Furniture

obviously, that in itself had its own environmental impact, because they were getting through a lot of hardwood in the 1950s and 1960s. Using a lot of mahogany from the rainforests was not a consideration at that time.

“Before teaching, I started life as an engineer. I left school at 16 and trained to be a press tool maker

“

I’ve never trained to be a woodworker. I’ve only ever picked up woodworking skills along the way

”

with British Leyland. I did a four-year apprenticeship, then I started re-educating myself. I went and got an HND in mechanical and production engineering, and did a teaching degree from there. I veered off from engineering and got into teaching.

“I taught design and technology for 28 years, so that’s wood, plastic, metal. I’ve never trained to be a woodworker. I’ve only ever picked up woodworking skills along the way. But I do think that having an →



REGULAR



Above ♦ The oak parts of this wine cooler came from a barn conversion

engineer’s brain helps; it’s all about precision and care.

HANDS-ON

“There are various different steps along the way to upcycling. Where you first get hold of the piece, you either have to strip it back to its bare bones – that might involve sanding or dismantling, or whatever that might be; anything that needs fixing gets fixed; anything that needs painting or varnished gets done; then it’s reassembled. Fairly basic steps, but then in among all that you get the detail and the complexity of repairing things – the best way to repair them, the best equipment to use.

“The only thing I don’t do is welding or upholstery. I have an upholsterer who works with me – he’s very reliable and experienced. I don’t do things like sofas and such-like, the bigger stuff, but if somebody came to me with some kitchen chairs that had an upholstered seat, I’d get him to do those for me.

“The business has gone in the direction of custom builds more than anything. I do a lot more commissions than I do upcycles. People either ask me for something specific, or they ask me to repair or refurbish or upcycle a piece for them, and I’ve also done fitted furniture, wardrobes, built-in cupboards, bookcases, that sort of thing. I’ll have a go at most things, but I’m happiest doing upcycling and restoration.

“I don’t go down the road of restoring antiques, because it’s not my field. I’m not an expert in that kind of area. I wouldn’t do French-polishing, that kind of thing, because I haven’t been trained in that kind of stuff.

“At the moment I’ve had a commission, about four weeks ago, from a chap who came into my workshop. He’d seen my website, called into the workshop, had a look around – he was just moving house with his family. He started me off on two things: I’m working on a teacher’s desk with six drawers, an old beech desk, and I’m also doing an old gym bench cut down to four feet long rather than eight feet long, for his children.





Below ♦
 This glorious gentlemen's wardrobe has now been transformed into a drinks cabinet



“There are lots of horrible shabby chic, slap-some-paint-on upcycles out there, and there are lots of professional upcycles out there as well. It all comes down to personal taste at the end of the day.

“If you look at the television programmes that are popping up at the moment, e.g. *The Repair Shop*, there’s a move toward saving stuff that’s got meaning to you. Upcycling has suddenly become very popular. The reason for that is people are looking around their homes looking at old, good-quality items that have potentially got another lease of life in them, and they don’t want to see them thrown into landfill. They’re looking at upcycling as an option. It’s here to stay.” □



Social engagement

How I make social media a positive experience



Lucy Rogers

[@DrLucyRogers](#)

Lucy is a maker, an engineer, and a problem-solver. She is adept at bringing ideas to life, and is one of the cheerleaders for the maker industry.

Many of us use social media – for entertainment, news, and even to find and meet other makers.

Over the years I have posted things I later regretted, had things taken out of context, and I have completely not understood what I was talking about when I read the post back a week later – mainly due to me not writing clearly enough. I've also used social media to increase my engagement with others – for work or purely social things. As my social media persona is my 'professional' persona, I have developed ten tips that I try to keep in mind before I post:

1) Be positive. If you have nothing nice to say, don't say anything. If you don't have anything to add, either ignore or just simply acknowledge with a 'like'.

2) You don't have to respond to everything. And no one has to listen to you.

3) Be aware that everyone is busy. People not responding/liking is not a direct reflection on the quality of the post. Usually!

4) Keep PG rated. I am inadvertently a role model for children getting into STEM. Also, 'poop' is funnier than the rude alternative.

5) When asking questions, be explicit in what you are looking for in a response.

"Does anyone have any *personal* recommendations for X please?". This often stops people just Googling and sending the first thing listed.

6) Engage with a "yes, and ...". Keep the conversation rolling. "How would you do that?" – "Interesting, tell me more."

7) Mute and block easily. Don't engage the trolls. For me, social media is a place of fun and learning. I don't need other people's negativity.

8) Be curious and encouraging. "Ooh,

that's interesting ... tell me more" – but do not do this if it's easily searchable! And read other people's responses before asking your own – the poster may have already been asked the

People not responding/liking is not a direct reflection on the quality of the post

same thing 20 times.

9) Join in other people's tweets/conversations. Only if relevant and not intrusive! Don't one-up though, "I did that but bigger, better, etc." It won't win friends.

10) In a post, you don't get all the information. Don't be definitive – and try not to shut people down. "I thought that..." is better than "This is so...". And "About the size of a bath-tub" is better than "1.6 m × 0.7 m × 0.7 m". However, if someone wants the dimensions of a bath-tub, then ignore this tip. □

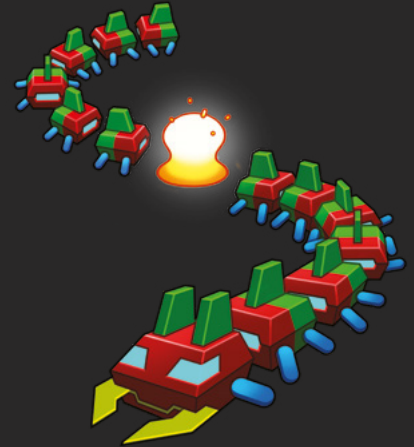
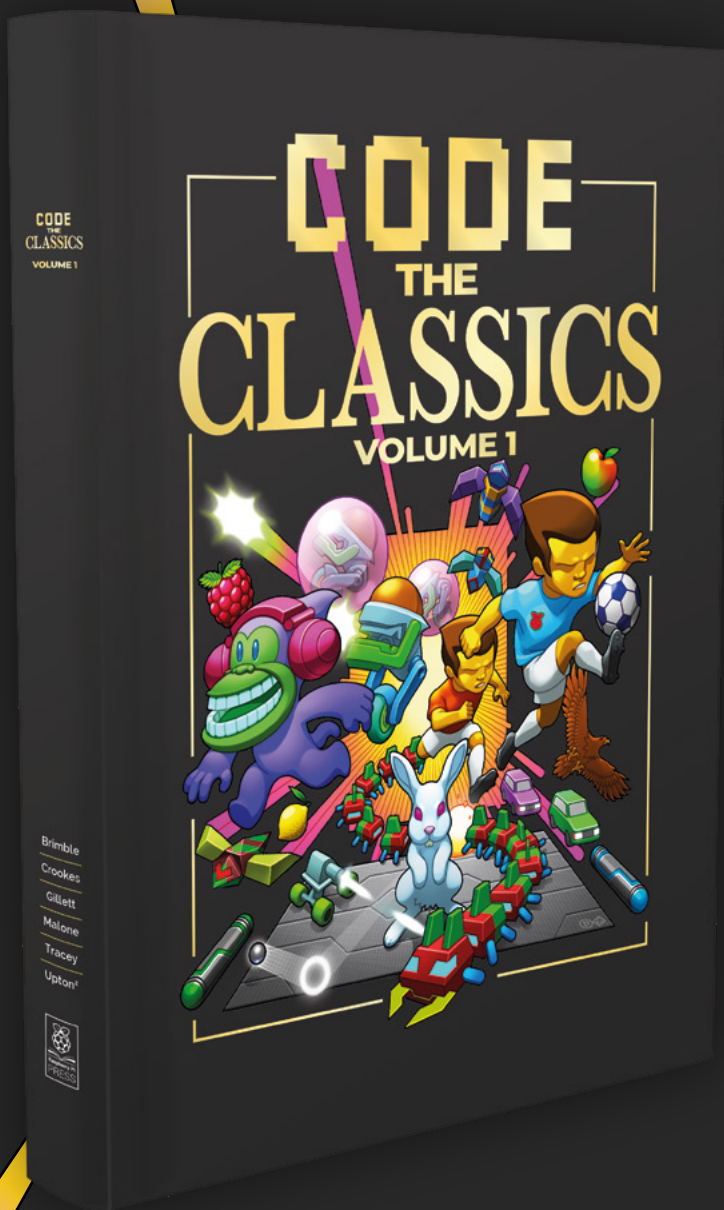

- *Get game design tips and tricks from the masters*
- *Explore the code listings and find out how they work*
- *Download and play game examples by Eben Upton*
- *Learn how to code your own games with Pygame Zero*

This stunning 224-page hardback book not only tells the stories of some of the seminal video games of the 1970s and 1980s, but shows you how to create your own games inspired by them using Python and Pygame Zero, following examples programmed by Raspberry Pi founder Eben Upton.

Available now: hsmag.cc/store

Letters

ATTENTION ALL MAKERS!

If you have something you'd like to get off your chest (or even throw a word of praise in our direction) let us know at hsmag.cc/hello

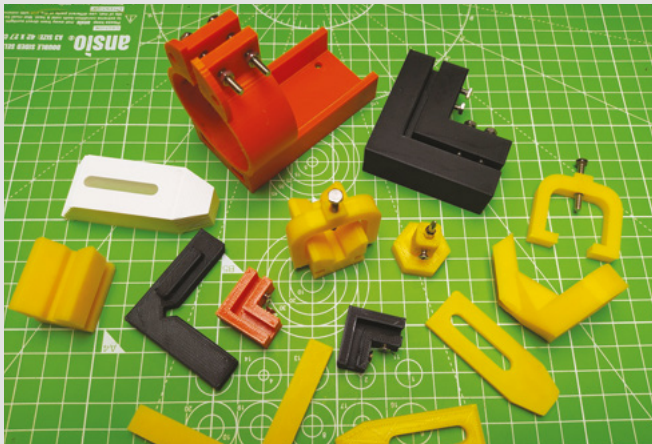

3D PRINTING 1

I think I just might be starting to understand 3D printing... No, wait! Stay with me! I've got no time for tabletop gaming, I don't have any interest in comics, or Marvel, or World of Warcraft, so the occasional 3D-printed sword or whatever just doesn't appeal.

What's turned the tide are the functional 3D prints in last issue [*Functional 3D printing, jigs, and tools*, issue 36]. If I need a jig, I normally bodge one together out of scrap wood, but if I ever need anything that's non-bodged, I know exactly what to do now. Finally – I see the point!

Dave

Ohio

Ben says: Jo Hinchliffe has done some brilliant machining tutorials for us, and now that he's branched out into 3D printing, he's brought the same sense of usefulness and why-didn't-I-think-of-that-ness that he brought to the previous tutorials. I've been playing with different types of filament recently, with the result that I've got loads of spare odds and ends for making small functional parts. Yuuge win!

MUSIC

The purring tentacle is the weirdest thing I've seen in a maker magazine. Not weird in a bad way. But it's still weird! And now I want one for myself!

Ian

Coventry

Ben says: If you like weird musical projects, you're in for a treat: at this very moment, we're working on a book filled with DIY music projects. Physical music, that is – there are already lots of resources for synths out there, but we wanted to do something to showcase the incredible possibilities of DIY sound and music creation. Keep an eye out for it early next year.





3D PRINTING 2

The embroidered keycaps [by Billie Ruben, in issue 36] is a brilliant idea! I'm coming to realise that the genius of 3D printing isn't in the final objects that you make, but in the intermediary object it enables you to make, and this is a great example. Plastic is a bit boring, but once you've added some 100% Hebridean lambswool, you've got a luxury item.

Rachel

Newcastle

Ben says: The embroiderable keycap is a fusion of three worlds – mechanical keyboards, 3D printing, and traditional crafts – and, as such, it's right up our street. Again, why did no one think of this before?

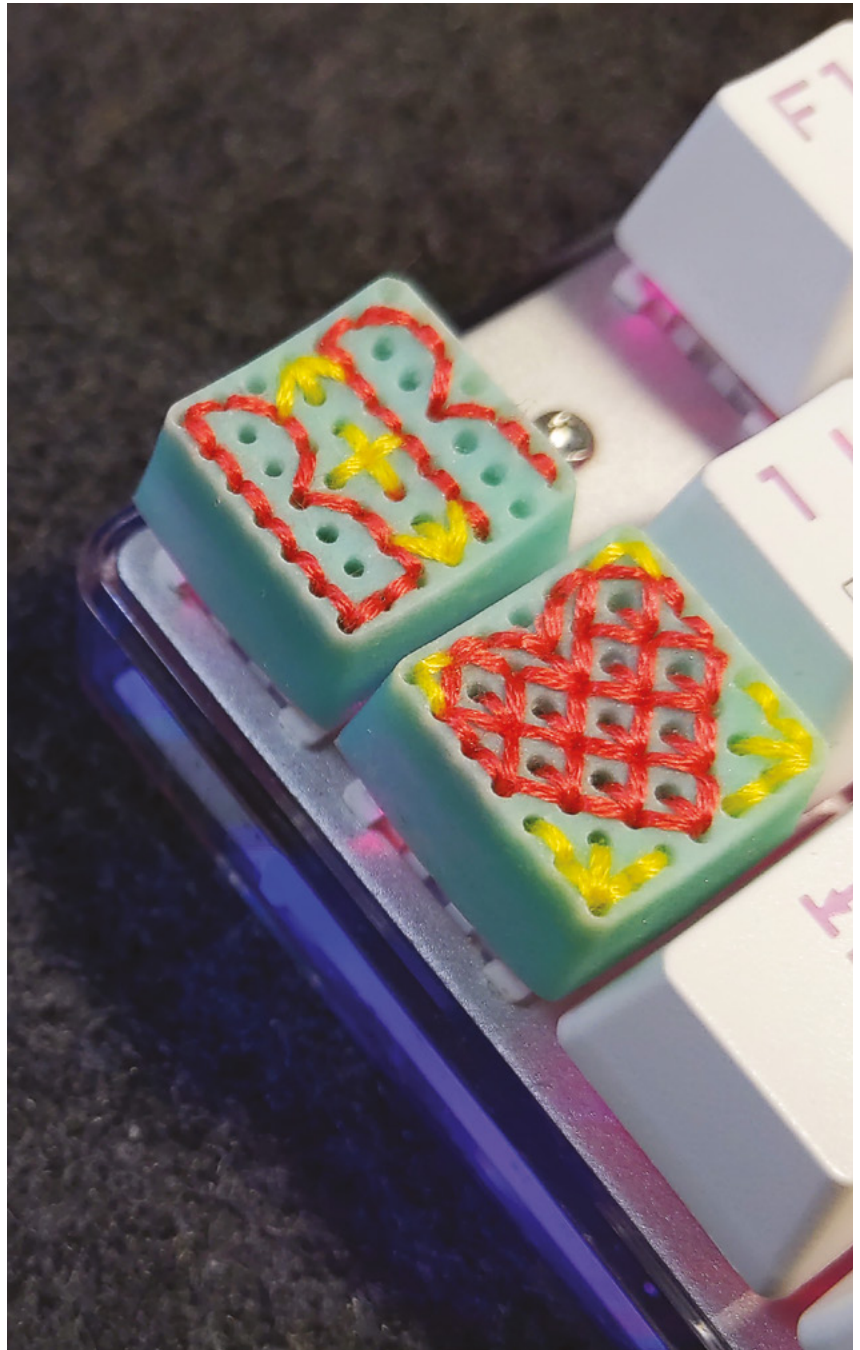

CROWDFUNDING NOW

Cakewalk 3D

A 3D printer adapter for icing cakes

From €49 | [kickstarter.com](https://www.kickstarter.com) | Delivery: December 2020

People have tried to 3D-print with food for almost as long as hobbyists have been 3D printing. It's an obvious area for experimentation, and there are some materials that behave at least a little like 3D printer filament, in that they're sometimes solid and sometimes liquid. Cakewalk 3D is the latest project attempting to combine rapid prototyping with the culinary arts. It is a food extruder for your 3D printer that uses a screw to push a softish liquid out of the nozzle. If you select the 'Standard Kit' (for 89 euros), you'll be supplied with all the bits for the extruder and design files for mounts for popular 3D printers that you can print yourself.

As you might guess from the name, Cakewalk 3D is selling this as an option for icing cakes (or anything else that has a gooey, colourful liquid colourfully laid on top). Pop the cake on your print bed, put the design for your decoration through your slicer, and automatically squirt it on.

Anyone who's ever set up a printer will know the importance of setting the first layer height. When the print bed is a knobby cake, you're never going to get an accurate height and, even in the demonstration video, you can clearly see unevenness in the results caused by this. In some cases, it's the nozzle dragging through the icing, in others, it's due to the fact that the cake has been too far away and it's lost definition.

We haven't been able to test a Cakewalk 3D, but for us, the most impressive thing about it is the ability to manipulate images in ways that would be hard to do by hand. For example, slice up an image into

multiple parts and divide it between different items so that they make one image when put together. Or, it would be interesting to see some edible algorithmic art (take a look at the **#plottertwitter** hashtag on Twitter for some excellent examples of this).

If you're expecting this to be an easy way to get photorealistic artwork on your baked goods, then you're going to be in for a disappointment. However, if you're passionate about tinkering with both technology and food, there's undoubtedly some fun to be had with this. □

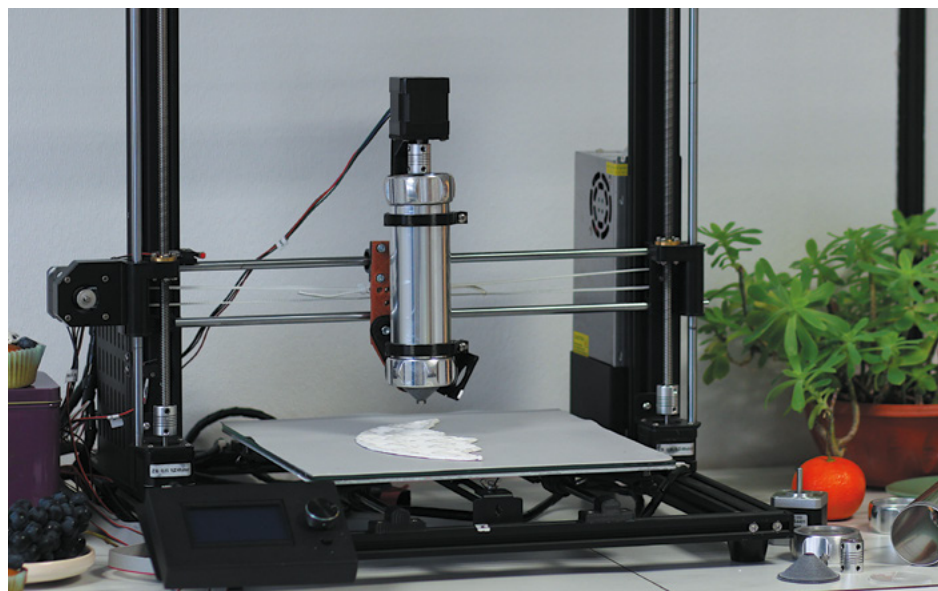



BUYER BEWARE

When backing a crowdfunding campaign, you are not purchasing a finished product, but supporting a project working on something new. There is a very real chance that the product will never ship and you'll lose your money. It's a great way to support projects you like and get some cheap hardware in the process, but if you use it purely as a chance to snag cheap stuff, you may find that you get burned.





Build a Makerspace for Young People

Join our **free online training course on makerspace design** to get expert advice for setting up a makerspace in your school or community.

Sign up today: rpf.io/makerspace

LENS

HACK | MAKE | BUILD | CREATE

Uncover the technology that's powering the future

PG
48

HOW I MADE: A FACE MASK

... but not just any face mask!
This is a sound-reactive,
scrolling LED face mask!



PG
54

INTERVIEW: ROB IVES

Meet the master of
mechanical origami

PG
62

IMPROVISER'S TOOLBOX: CARDBOARD

Turn waste packaging into
almost anything

PG
34

BUILD A ROBOT

Design and make a perfect
robotic companion

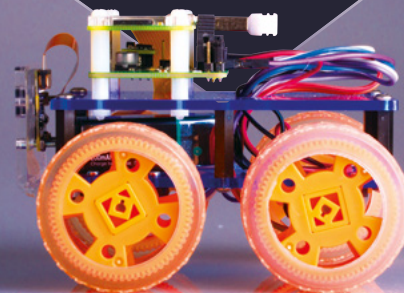

PG
66

MAKE A MAKER BUSINESS

Business secrets of the makerverse
revealed in eight easy steps

ROBOTS

Electronically controlled vehicles

By Jo Hinchliffe

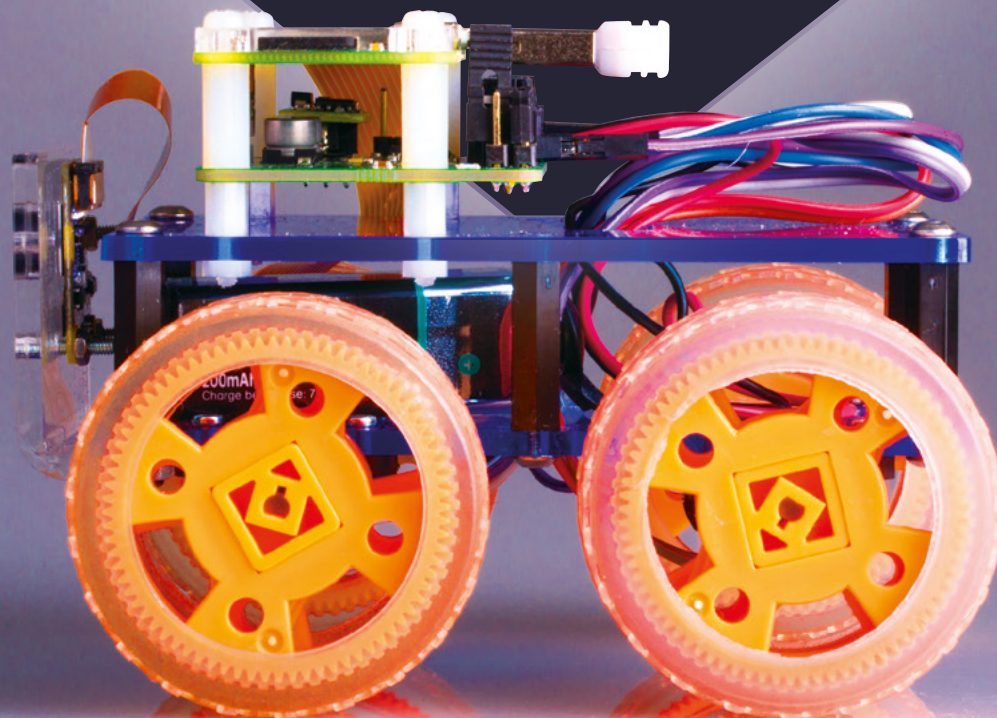

Robots come in many forms and perform many tasks, but a few things always have to be true.

They need to have a way of moving, whether that's across the land, through the air, or through the water – they must also have some form of electronic control. This may be a simple way for a human to control it, or it could be fully autonomous and think for itself.

Robots can be hugely complex machines, but they don't have to be. In this article, we'll walk you through the options for building your first rover – how to pick the right parts and get it all working together. Once you've got these bits together, it's up to you where you go from there. Do you want to build a fighting robot? An autonomous bot? Take to the high seas?

It's never been easier to get the bits you need to design and make your own robotic creation, so what are you waiting for? Let's get started with your own robot design. →

PICKING A CHASSIS

Get the right base for your bot

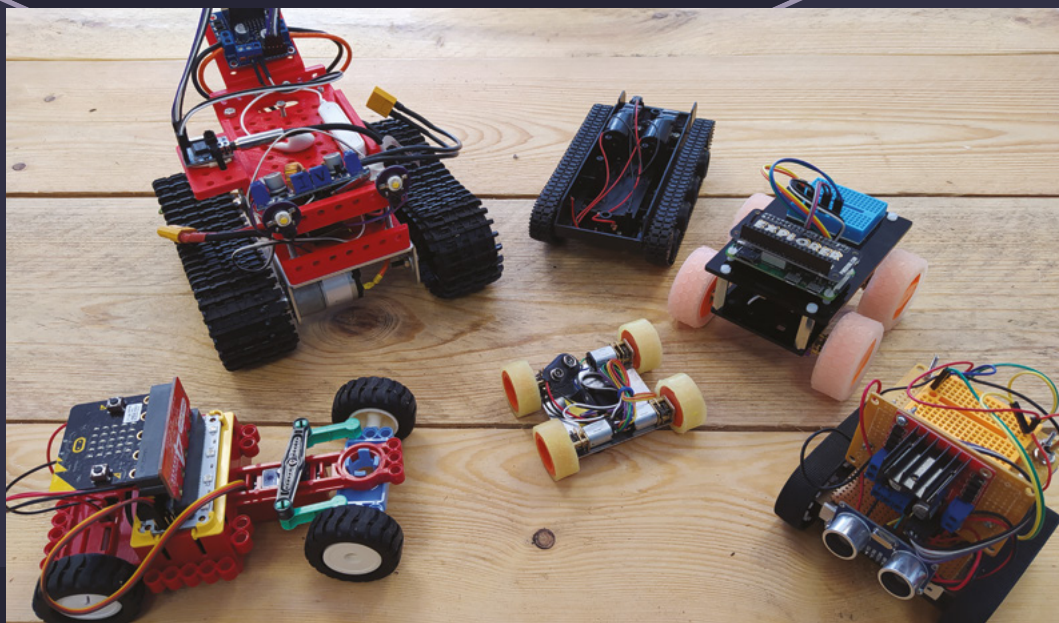

Right

A collection of robot rover chassis

Below

A newer product is the Valenta Off Roader, a joint project by hummingworks and 4tronix

Building a robot can take many forms, but a common starting point is to build some kind of land-based roving vehicle. There are many advantages to starting with a robot rover. It won't fall out of the sky or sink in water if something goes wrong, parts are readily available, and lots of people have already built and shared all kinds of projects to learn from. Much of what you will learn from building a robot rover will apply when you go on to build other robots. Knowledge of how to drive and control motors, controlling servos, and using sensors to inform your robot's behaviour are all skills you will develop, so it's definitely our recommendation to start with a rover.

One of the first choices you need to make is deciding what type of chassis you want to build.

A common starting point is to use an off-the-shelf chassis kit which includes the running gear, motors, and some kind of area to attach stuff too. Let's look at some chassis options.

First up is a classic chassis: the Pololu Zumo chassis kit. This small-tracked chassis kit is often sold because it's compatible with the rules for most Mini Sumo robot fighting leagues – it's lightweight and under 10 cm × 10 cm. However, don't worry if you don't want to fight: it's still a great chassis to build a small robot on. It features two micro gear motors connected to two drive-wheels, a pair of idler wheels, and some rubber tracks. Also built into the plastic chassis is a battery compartment for four AA batteries. On top of the chassis, there's a plate with a grid of imperial #2-56-sized holes with nut recesses; however, we've found that if you are building them outside the US, metric M2 nuts and bolts will fit as



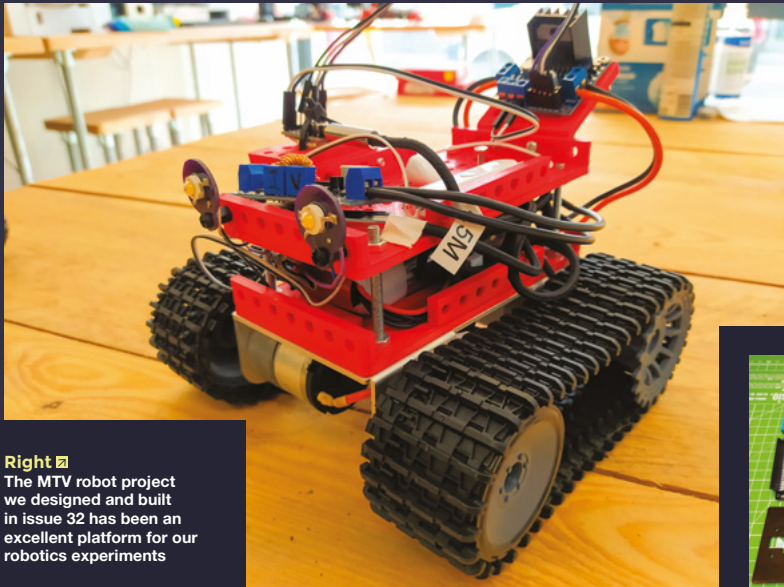

Right  The MTV robot project we designed and built in issue 32 has been an excellent platform for our robotics experiments

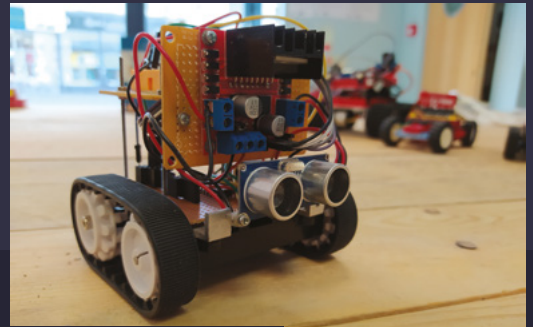

Above  A small DIY obstacle-avoiding robot built onto a Pololu Zumo chassis

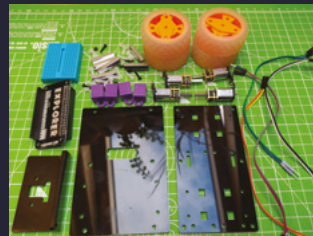

Left  The Coretec Tiny 4WD chassis components make for a straightforward chassis assembly

well. This grid of mounting points makes it easy to add electronics, or to add extra layers to the chassis to mount accessories on.

The Coretec Tiny 4WD chassis kit is a classic kit hailing from the UK which combines laser-cut panels and standoffs to form the chassis, and uses injection-moulded mounts for the micro gear motors. The micro gear motors for the Tiny 4WD are special ones from Pimoroni that include a breakout PCB so that you can wire the motors up using standard DuPont cables and you don't need to solder them. This kit uses four

Go your own way

Of course, if you want, you can totally DIY the chassis of your robot. While 3D printing, CNC routing, and laser cutting have all given birth to myriad DIY robot designs, there are plenty of examples of handcrafted chassis out there made from inexpensive materials or upcycled waste. Get creative! We've been working on a small chassis that's been CNC cut and folded to accommodate four micro gear motors. We've designed and printed some wheels, and even gone as far as casting some silicon tyres. The DIY spirit is very much alive in the robotics scene, and you can find excellent projects and examples for inspiration and instruction online.



motors to achieve a true 4WD, and also includes an Explorer pHAT board that stacks on top of a Raspberry Pi Zero (not included) which has motor drivers and other I/O pins and functionality for your robot build. While this is a more expensive chassis, it is very nicely designed and has heaps of support materials for all kinds of builds and adaptation online. We'll look at how to put together the Tiny 4WD later in this article.

In issue 32, we built an open-source modular tracked vehicle (MTV) which utilised a cheap tracked chassis kit that can be found online. This chassis has various names and descriptions, but can often be found by searching for 'tracked robot car crawler kit'. This chassis is great in terms of budget, but it's supplied without any instructions, and it also takes some experimentation to work out how to put it all together! This chassis kit includes two powerful 12V geared motors, two drive wheels, two idler wheels, plastic tracks, and the steel chassis. Our MTV project files contain lots of 3D-printable accessories for this chassis; however, the chassis doesn't have any official accessories, so it's a case of making your own. For more information on how we built this robot, take a look at issue 32 (hsmag.cc/DACrkH).

The Valenta Off Roader is a product by hummingworks and 4tronix. It features a cheerful and tough chassis, with 2WD at the rear and servo-controlled steering at the front. This format means that it looks and drives more like a car, which may be attractive to some builders. Similar to our MTV design, it features a lot of mount points, but these are designed to be compatible with Lego Technic rods/pieces. The Valenta kit comes with a smart driver board for the motors and servos. It also features some programmable RGB LED NeoPixels, and is designed to be driven by a micro:bit. →

Roll on

An early consideration is whether your robot will ride on wheels or tracks. Yes, indeed, you could build a walking/crawling robot, but again, they are more complex. There are advantages and disadvantages to both wheels and tracks. Wheels are common and can work well with simple robots, often having just two driven wheels and a castor-wheel that pivots and turns with the movement of the chassis.

Tracked systems tend to have one driven wheel per side that engages with the track, in turn, rotated around one or more additional idler wheels that spin freely. Tracks can be better across a variety of terrain and they have a larger contact footprint than wheels, so they may have better traction.

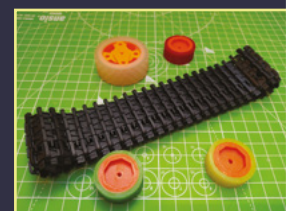

SILICON BRAINS

The electronic bits your robot needs to think (or move)



Left Numerous controllers for robot projects including a micro:bit, a Rock Candy PS3 gamepad, the Kitronik Move app, and a small wireless keypad

Aside from hobby-grade radio control systems, there are other considerations if you want to have a controlling transmitter linked to your robot. There are lots of options out there.

A common solution is using a Bluetooth or 2.4GHz wireless game controller. This is particularly suited to Raspberry Pi-based robots where a receiving USB dongle can be physically connected to the robot – numerous scripts and Python libraries have been built in the community

to help set up these connections. Similarly, if you are using a Bluetooth-enabled control system, such as the micro:bit or the Raspberry Pi Zero W, there are numerous smartphone apps that have been developed as robot controllers. Kitronik has an app designed to work with the micro:bit called 'Kitronik Move' (hsmag.cc/YmpCLF), for example, and another popular app is 'Blue Dot' which is a simple interface of a moveable blue dot that can be configured to link to control systems. We've already mentioned the idea of using a micro:bit as a remote control, and while only having two physical buttons

Mechanical movement

Whilst we would love to see more steam powered robots, it's true to say that electric motors and/or servos are most common in robot rovers. A lot of the robots featured here are using the micro gear motors which are available in a vast range of gear ratios and revs per minute at different voltages. So, if you want to make a fast racing line follower, or if you want to make a slow crawler, there's an option for you. Stepper motors can be useful where accurate amounts of rotation are needed, as can adding encoders to provide feedback on a motor's movement. Servos can be adapted or bought as continuous rotation types and used in drive systems, or standard servos can be used to control steering systems and other articulated parts of your design.

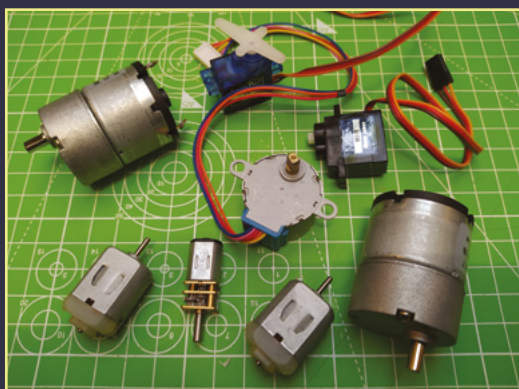

might at first seem fairly limited, the micro:bit's accelerometer and other sensors mean that it's straightforward to set up some gestural control movements such as tilt forward, tilt sideways, and shake. This can be an excellent way to create a simple controller. Finally, not to be overlooked, we've also seen excellent use of small wireless keyboards as robot control systems. This can vary from a simple mapping of keys to create forward, reverse, left, right functions, through to people actually typing commands to switch robots between different command sets. Of course, many people build their own control systems using radio modules and microcontrollers, and for a more esoteric control system, we looked at using DTMF (or touch-tones) on a smartphone to control the MTV robot in issue 35 (hsmag.cc/8xQ5JG).

If you want to make your robot more autonomous, you'll need a controller board which not only controls the motors and servos, but will also handle and interpret information from sensors that you might want to add to your build. There are lots and lots of microcontroller modules out there; however, there are three platforms that stand out: Raspberry Pi, Arduino, and micro:bit.

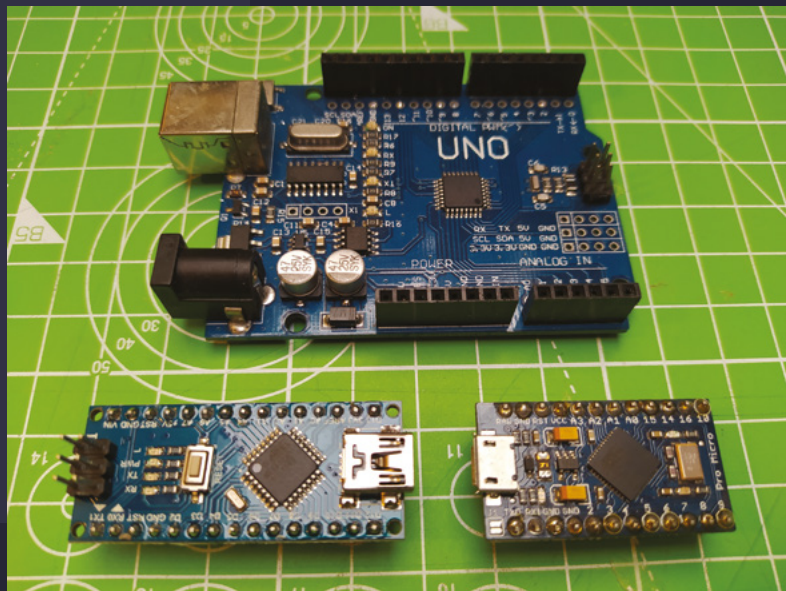

The micro:bit is a great way to get started in robotics. It has a variety of ways that it can be programmed, including the simple block-based MakeCode editor, MicroPython, and more. Using the MakeCode environment, there are code blocks for motor control and servo control, and if you have two micro:bits, it's pretty easy to create a system with one micro:bit acting as a transmitter sending instructions to the micro:bit on the robot. Standalone, the micro:bit only has a few pins available, but there's a range of breakout boards that can help expose the full functionality of this fantastic board. There are many off-the-shelf robot kits, such as the Kitronik :MOVE mini MK2 robot which we reviewed in issue 29 (hsmag.cc/0Vt4EY), but it's also easy to DIY a robot control system using micro:bits as we did with the MTV robot in issue 32.

The Arduino family of microcontroller boards are commonly seen controlling robots and their sensors. There's a large variety of Arduino flavours, from the very small footprint Pro Mini through to the powerful and many-pinned Arduino Mega. There is a huge community of people online →

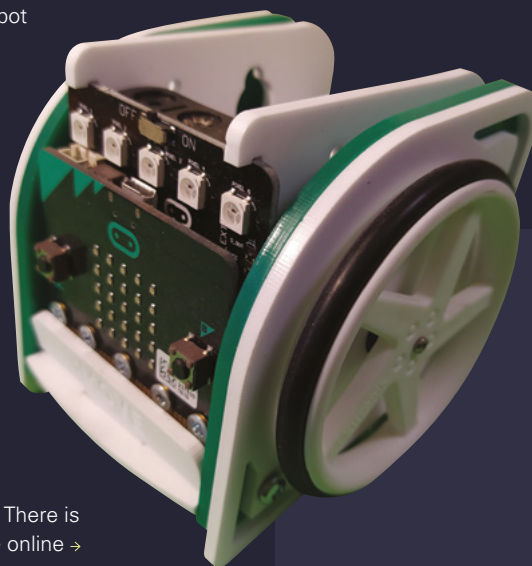

Above ♦ Arduino is a classic family of microcontroller modules that have an extensive user community and resources online. Arduino has been at the heart of many DIY robot projects

Below ♦ The Kitronik :MOVE mini MK2 robot is a great example of a micro:bit-controlled robot



Remote control

Having made some decisions on what type of chassis you might like to build a robot on, you will need to think about the control system that it uses. It might not seem obvious, but an early decision to make is: do you primarily want to create a robot that controls itself, or a robot which you control similar to a radio-controlled vehicle? If you totally want to drive the robot yourself, and you aren't too interested in adding sensors or other accessories, it might be worth considering using radio control systems. An RC system would look like a transmitter and a receiver, plus some ESC (electronic speed controllers) which, for all of the above chassis, would be ones made for brushed motors. Similarly, a hybrid system combining both RC and microcontroller might be a useful approach. In issue 33 (hsmag.cc/4Tt1We), we looked at combining RC and Arduino using the `pulseIn` function to map RC control signals to other formats the Arduino could use.

**“ THERE ARE
A PLETHORA OF
ROBOT-RELATED
ADD-ONS ”**

Below ■ The full-size Raspberry Pi and the small form factor Raspberry Pi Zero W are great candidates for an extremely powerful and flexible control environment for robot builds



who have used Arduino to build all different kinds of robots, and therefore there are lots of resources and examples available online, as well as libraries for many types of sensors. Plug-in 'shields' also mean that there are a plethora of robot-related add-ons for Arduino, helping roboticists realise their designs.

Raspberry Pi has a long legacy as a robot controller board, and there are lots of different examples around to research. Since the release of Raspberry Pi Zero W, with its small form factor and wireless capabilities, this seems to be the go-to flavour of Raspberry Pi for many projects. The power of having a full Linux operating system at your disposal for your robotic creation means you really are only limited by your imagination! Again, similar to other platforms, there is a huge community of people building robots with Raspberry Pi, so there are stacks of resources online and in print.

Apart from a microcontroller, you will usually need some kind of board to control your motors or servos – these can range from DIY simple MOSFET circuits, through to ICs specifically designed to drive different types of motor.

The L298N motor driver module is a cheap and readily available board that can be used to control either a single stepper motor or, more usefully in our case, drive two DC motors. The L298N is useful across a range of voltages – it can drive a pair of DC motors bidirectionally (forward and reverse), and it can also vary the speed control of the motors. It's commonly sold as a PCB that can operate at 5V or 12V – if operated at 12V, it can also supply a regulated 5V output. Supplying a current up to 2 amps, the L298N can drive a wide range of motors and is a cheap, functional way of getting motors under control,

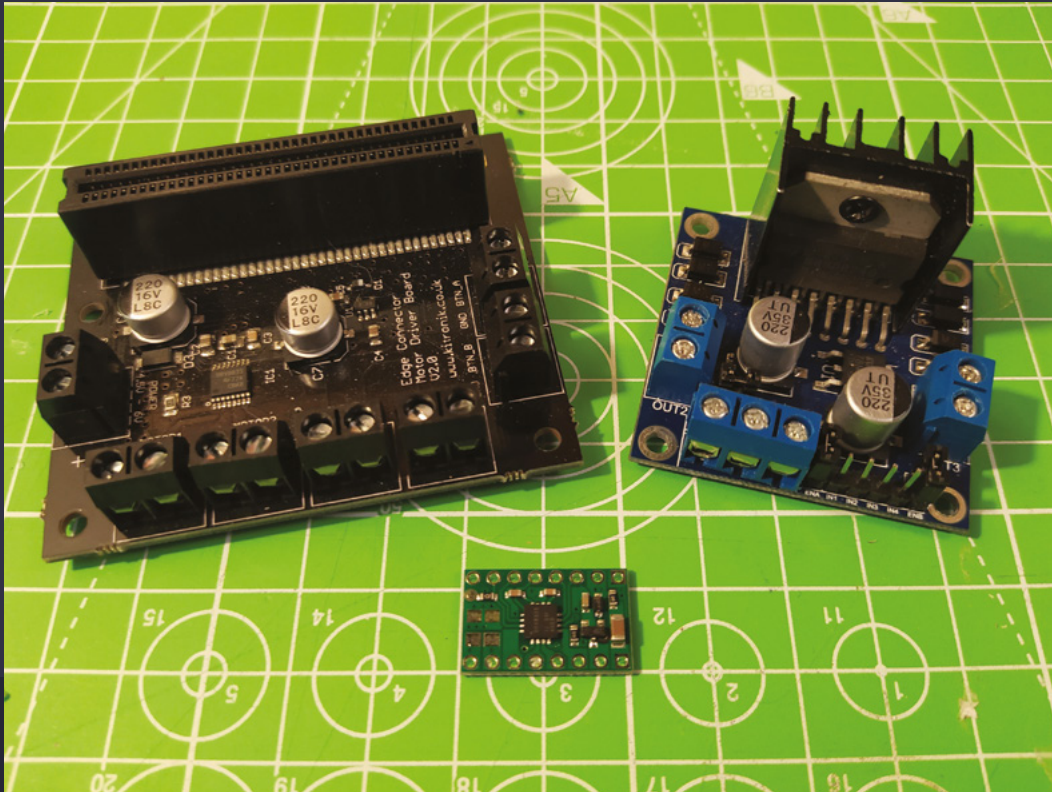

Left ◀
A collection of motor driving electronics options, from the large Kitronik motor driver and breakout board for the micro:bit, to the medium-sized L298N module, and the small DRV8833 breakout from Pololu

particularly so in terms of setting up tank-type control systems. The only slight downside to the L298N is that it's quite a large board with a large heatsink, so it may be tricky to accommodate it in a compact build.

The DRV8833 is another common motor driving IC which is included on lots of motor driver boards from different companies. Pictured (above) is the Pololu breakout board for this IC, which is tiny and capable of driving two brushed DC motors between 2.7 and 10.8 volts. It can supply 1.2 amps per motor continuously, and up to 2 amps in short bursts. It's a great compact option for small robots using smaller motors.

The Explorer pHAT is a board that comes with the Coretec Tiny 4WD robot chassis kit and has DRV8833 dual H-bridge motor drivers on board, as well as a wealth of other inputs and outputs useful for creating robot platforms. While the Explorer pHAT is designed to be compatible with Raspberry Pi Zero, it will also work with other boards such as the Arduino family or Adafruit's Trinket. The pHAT version is the smaller sibling of the larger form factor 'Explorer' board from Pimoroni, and the latter has similar functionality but also includes crocodile clip points and a small breadboard to enable easy experiments. The larger Explorer pHAT fits the full-size Raspberry Pi footprint. →

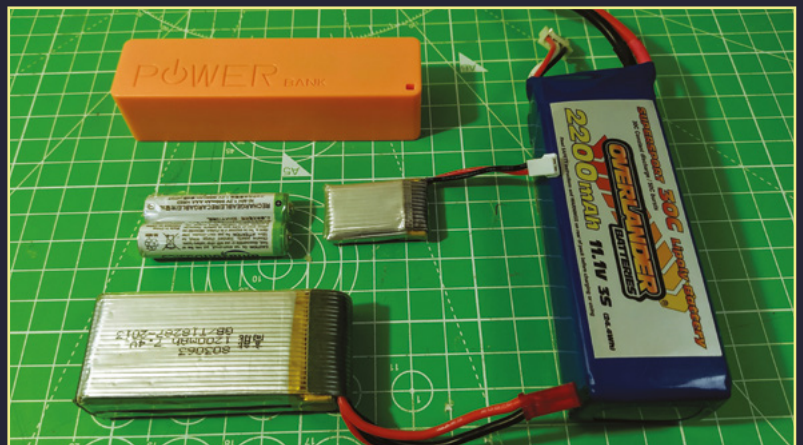

Adding electrons

Powering your robot creation is usually a job for batteries (of which there are many options). AA batteries are common, but increasingly so are LiPo rechargeable packs. Again, the hobby RC industry means that there are plenty of options and information for LiPo packs. We'd urge you to read around the subject if you are new to using LiPo, as they need a little care in use, recharging, and storage. However, LiPos are a great choice as they can supply a lot of power from a small footprint. Another battery option is to make use of USB power banks which are commonly available for 5V output in a variety of sizes and power ratings. One advantage of USB power banks is that they contain charge circuitry, which means you don't require a specialised charger and can simply recharge from a USB power source.

POWER-UPS

Add more features
to your robot

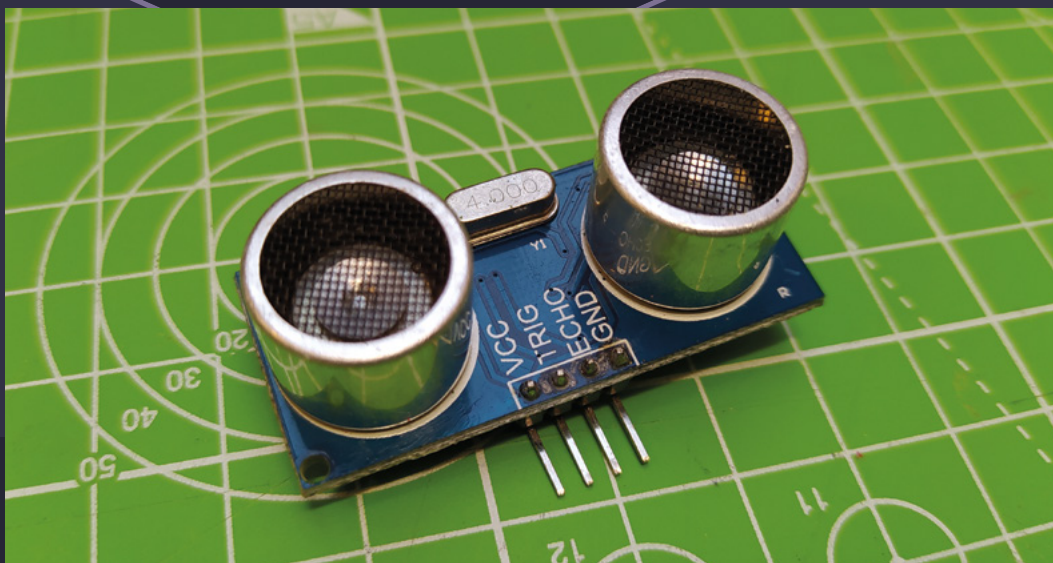

Having chosen your chassis type and your main control system, you may well want to add some power-ups to your robot to enhance what it can do.

From simple switches through to AI cameras, there are heaps of wonderful things we can add to robots!

A common power-up is to add ultrasonic sensors to your robot which can be used for things like obstacle avoidance. Ultrasonic sensors emit an ultra-high frequency signal (you can't hear it), and they measure how long it takes for this signal to bounce back and be heard by the sensor. From this, you can work out how far away an object is. You can then, in software, create code that makes the robot

perhaps reverse and turn when it detects an object within a certain distance. This robot should then be able to navigate around a space without crashing into things.

Bump switches are a super-simple way to add a sensor to a robot. The idea is that you add a switch that, when pressed, causes the robot to stop, reverse, and turn away from the obstacle. They can be made from any lightweight microswitch – all they need is a bumper adding to help press the switch when it hits an object. As microswitches can take very little force to switch them, a bumper can be as simple as adding a small section of stiff wire, which creates a whisker-type sensor, to a robot. So, similar to a cat, if the whisker doesn't fit through a space, then the robot won't!

Above ■ The HC-SR04 is an affordable and common ultrasonic sensor module that can add range and obstacle detecting to your robot rover

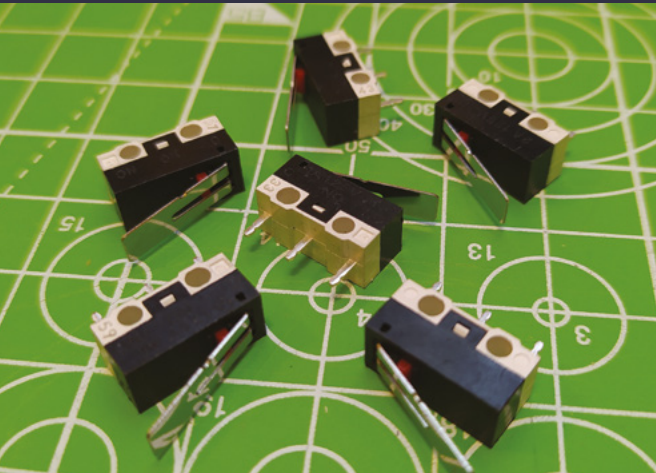

“ A COMMON POWER-UP IS TO ADD ULTRASONIC SENSORS “

It's become common to add cameras to robots, and they can be used in many different ways. Simply using a wireless camera so that the operator can have a first-person view (FPV) on board the robot can add a fantastic new way to drive the robot. Cameras interfaced with a microcontroller like Raspberry Pi can be used to detect motion, or detect colours of objects. For example, using an environment like OpenCV for computer vision projects, you could design a robot to recognise and navigate to certain objects. Camera power-ups often go hand in hand with pan-and-tilt systems, where a camera is added to a hinged platform that can rotate the camera on two axes. There are lots of examples and free models of pan-and-tilt systems to download online for 3D printing. You can, of course, also use pan-and-tilt systems for other sensors. On our to-do list is an ultrasonic sensor on a pan-and-tilt system which, after identifying an obstacle, can scan left and right and then decide the best route.

Line detection sensors work in a similar way to the ultrasonic sensors in that they emit a signal and then measure the returning 'reflected' signal. However, most common robotics line detector sensors use infrared light and measure the returning density of light reflected. This means that they can be set up to detect a line on a plain background surface underneath the robot. It can be great fun to create tracks from strips of

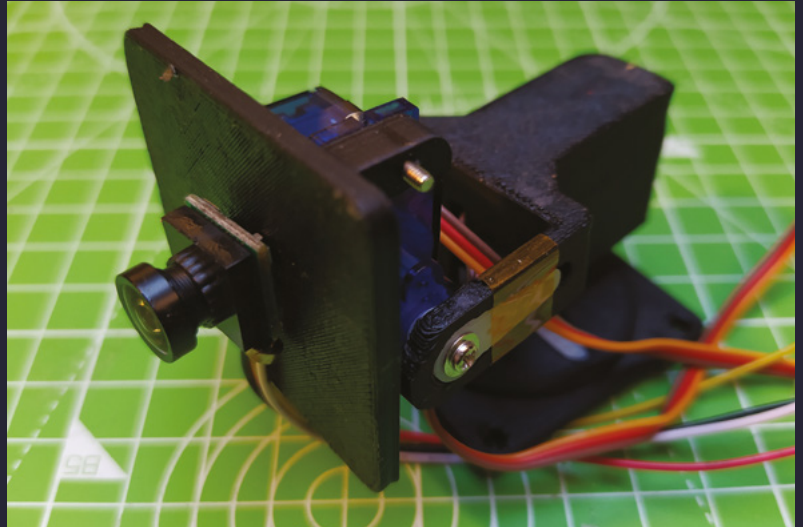

black PVC tape and watch your robot creation attempt to follow the line. There are lots of robot competitions that use line-following as a challenge – they even add complexity such as line crossroads where decisions will need to be made. Line-following hardware can also be used for other types of sensor or control. A common use for reflective-type sensors is edge detection, where perhaps you could have a desk-based robot realise and react when it is about to drive off the edge of the desk.

Gripping devices are another great idea to add to robots, allowing the robot to pick up and move objects. They can be a great technical challenge to get working reliably, and there are lots of design examples on websites such as Thingiverse. If you are interested in adding gripping devices, there is also the fabulous open-source MeArm robotic arm which is available as a kit; if you have access to a laser cutter, the design files are available. →

Going sideways

Mecanum wheels are a fascinating power-up you might consider for your robot rover platform. These wheels are capable of being used as standard wheels, but they also have a collection of 45-degree rollers built into the wheel diameter. These rollers enable the wheel to move at 45 degrees, and when you counter-rotate pairs of wheels, you can create a 4WD robot capable of moving sideways without turning. Four-wheeled robots with Mecanum wheels can also rotate about their axis (turn around within their own footprint) and are considered omnidirectional. Of course, each Mecanum wheel needs to be independently driven, so you may need more motor drivers and more complex control systems. Mecanum wheels are available off the shelf, but also there are numerous homebrew designs available online.

Above ♦
Cameras are a common addition seen on many robots – they can add a new dimension to driving and robot control

Left ▣
Not all sensors have to be high tech! Adding bump switches and some code can create a powerful obstacle-avoiding navigation control system



BRINGING IT TOGETHER

We build a simple 4WD robot

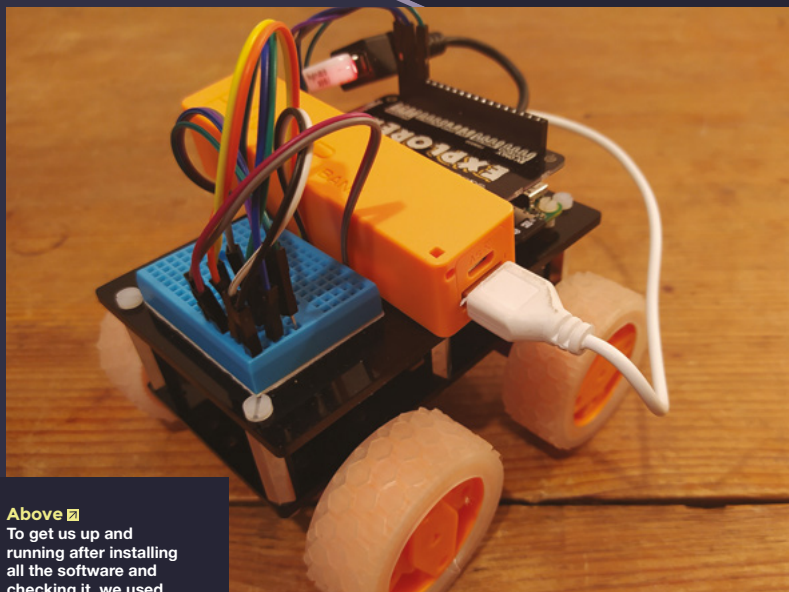

Above  To get us up and running after installing all the software and checking it, we used a small USB power bank and a USB OTG cable for the wireless controller dongle

Below  Bottom and top chassis plates assembled and the Explorer pHAT and Raspberry Pi Zero in place

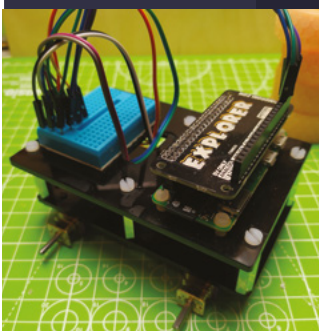

As an example, let's look through a straightforward robot chassis build by getting the Tiny 4WD up and running. The Tiny 4WD kit has online instructions for assembly on the Coretec website (hsmag.cc/uWelGa), and there are also numerous links to other makers' build instructions, so there's plenty of information out there to get you set up.

Building the Tiny 4WD is pretty simple. The kit comes with upper and lower plates which are joined together by metal standoffs and M3 nylon bolts, four micro gear motors and their housings, wheels and tyres, an Explorer pHAT, a mini breadboard, and an optional mount for a Raspberry Pi Camera Module.

The first task is to grab some of the included wire connectors and fit them to the header pins on

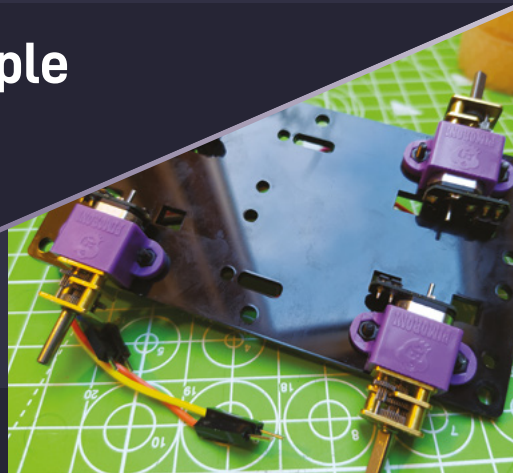

Above  The micro gear motors mounted to the chassis baseplate using the bolt-on motor mounts

the motors. The supplied micro gear motors have a PCB shim fitted onto the back with the header pins pre-soldered in place, so no soldering is required for this kit. Next in the physical build is to thread the motor wires through the corresponding spaces in the chassis, and then use the motor mounts and the small nut and bolts to fix each motor into place. Next, you need to connect the standoffs and, optionally, the camera mount plate if you want to – we didn't as we first wanted to get the simplest version of this chassis up and running before adding any power-ups. It can be a good idea to make sure that your chassis and drive components are all functioning before adding sensors, as it can eliminate complexity when debugging.

Next, you need to attach a Raspberry Pi Zero to the top plate and, in turn, add the Explorer pHAT. We then placed the plate on top and fastened it to the standoffs in position. As we attached it, we passed the motor wires through the hole so that they poked through the top plate. We stuck the mini breadboard in position and followed the instructions to patch wires between the Explorer and the breadboard and the motors. The Tiny 4WD is set up to have a single motor driver control two motors on a single side of the robot.

Having pretty much built the Tiny 4WD, we needed to install software and work out how to control it. We opted to pair the Tiny 4WD with a 'Rock Candy' wireless game controller, as we had seen examples of this in other build instructions. First, we hooked up our Raspberry Pi Zero to a monitor and, using a USB OTG hub, we connected a wireless keyboard. We had downloaded and copied the Raspberry Pi New Out Of Box Software (NOOBS) files to a formatted 16GB microSD card and inserted it into our Raspberry Pi Zero. Having installed and updated the operating system, we rebooted after additionally plugging in the Rock Candy game controller dongle to the USB OTG hub.

Now it's time to set up the software. If you have any trouble with this, there's more information at hsmag.cc/25Lczk. First, we needed to install the libraries for the Explorer pHAT. Pimoroni has made this simple by creating a script that installs this all for you so, making sure you are connected to the internet, open a terminal window and type:

```
curl https://get.pimoroni.com/explorerhat | bash
```

Say 'yes' to any prompts and you should get a message telling you to enjoy your Explorer pHAT. Next, install the Python 'inputs' library using pip. This is done by typing in the terminal window:

```
sudo pip install inputs
```

Coretec Robotics has stacks of example Python scripts for the Tiny 4WD, which include controlling the Tiny 4WD with a wireless keyboard, using the freely available 'Blue Dot' app, or the one we chose to try using the wireless game controller. To grab this script, type in the terminal:

```
wget https://raw.githubusercontent.com/Coretec-Robotics/Tiny_4wd/master/TinyPirate.py
```

Once this script has downloaded, you can run the script and check if the controller and the Tiny 4WD are working. Because we had everything plugged in, and the Tiny 4WD was connected to a USB power supply and the monitor, we didn't want the robot to move, so we chocked the chassis up on our desk so that the wheels could turn freely. To run the script we just downloaded, type in the terminal:

```
python TinyPirate.py
```

Twiddling the joysticks revealed that everything was communicating correctly, but we needed to swap one pair of wires to make the motors on one side turn in the correct direction. We then confirmed that forward, reverse, and left and right turn all

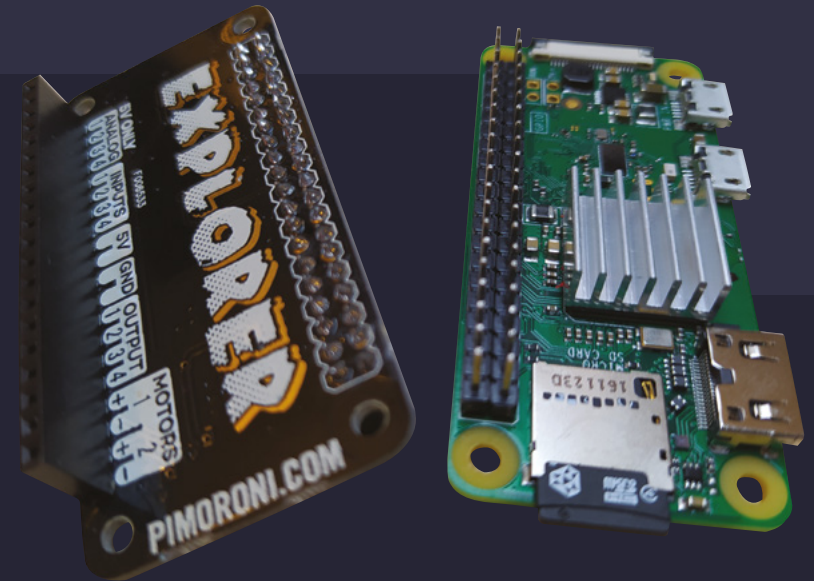

“IT EVEN DOES LITTLE WHEELIES WHEN CHANGING DIRECTION”

Above ♦ The only soldering that is needed to build the Tiny 4WD is to solder the male header pins onto your Raspberry Pi Zero, and the female header sets to the Explorer pHAT

corresponded with the joystick's movements. Once sorted, we turned our attention to making the script run automatically. To do this, we set up a cron job (see here for details: hsmag.cc/25Lczk).

Having sorted the software side of things, we did a quick reshuffle of the Tiny 4WD. We added a cheap USB battery which we conveniently discovered slotted in between the Explorer pHAT and the breadboard. We replaced the USB hub with a single USB OTG adapter cable for the game controller and then rebooted the Tiny 4WD. While this isn't a review, we do have to say it's an excellent little chassis to drive, and the motors are powerful enough that it even does little wheelies when changing direction – great fun, and good across a variety of surfaces.

We hope that, with this feature, we've inspired you and got you thinking about robot projects, whether off the shelf, or complete DIY, or somewhere in between. There is heaps of fun, learning, and perhaps useful applications to be explored. We hope you share all of your robot creations with us in the future. □

**SUBSCRIBE TODAY
FROM ONLY £5**



**SAVE
UP TO
35%**

Subscribe today and get:

- ▶ **FREE delivery**
Get it fast and for FREE
- ▶ **Exclusive offers**
Great gifts, offers, and discounts
- ▶ **Great savings**
Save up to 35% compared to stores

▶ **Subscribe online:** hsmag.cc/subscribe

SUBSCRIBE TODAY

Subscribe for 12 months

Rolling monthly subscription

£55 (UK)

£90 (USA)

£80 (EU)

£90 (Rest of World)

Free Circuit Playground Express with 12-month upfront subscription only (no Circuit Playground Express with rolling monthly subscription)

▶ **Low monthly cost** (from £5)

▶ **Cancel at any time**

▶ **Free delivery to your door**

▶ **Available worldwide**

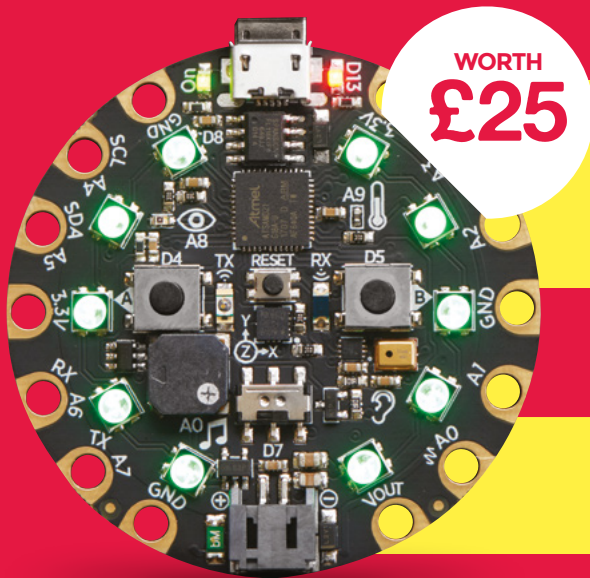

FREE!

Adafruit Circuit Playground Express

With your first 12-month print subscription

This is a limited offer. Not included with renewals. Offer subject to change or withdrawal at any time.

SUBSCRIBE on app stores

From **£2.29**



👉 Buy now: hsmag.cc/subscribe



How I Made A TALKING FACE MASK

Add some personality to your face covering

By Lorraine Underwood

Back in June, I saw a BBC article about an awesome face mask made by a programmer, Tyler Glaiel.

He put an 8×8 matrix of lights inside a face

mask and connected an Arduino and a microphone. The Arduino reacted to sounds he made and changed the animation on the matrix, so it looked like a mouth moving to his voice. ([hsmag.cc/bPgAlr](https://www.hsmag.cc/bPgAlr)).

I thought it would be great if the matrix actually was moving to your speech so that people who need to can lip-read from your mask. Of course, you can't lip-read in 64 pixels! However, I wondered if people could read text off of an RGB LED matrix that was inside a face mask. And then I thought, what if that could be transcribed directly from the wearer's speech? It was an exciting idea – I had the feeling all the technology existed, and just needed to be combined together in the right setup.



Some questions I had to begin with:

1. Is an 8×8 grid big enough to scroll text across?
 2. How accurate would transcription be?
 3. Can a computer understand human speech behind a face mask?
 4. How fast can transcription work in a live conversation?
 5. Will the electronics all fit inside a face mask while not interfering with the mask itself?
 6. Can you still breathe comfortably through the mask?
- It took a few iterations of the face mask, both in terms of software and hardware, before I got to a mask I was happy with.

VERSION 1: RASPBERRY PI WITH GOOGLE SPEECH-TO-TEXT API

For the first version, I used a Raspberry Pi 3 and connected to the online Google Speech-to-Text API. This was really just a proof-of-concept stage.

I was testing numbers 1, 2, and 3 above. The Raspberry Pi 3 board was never going

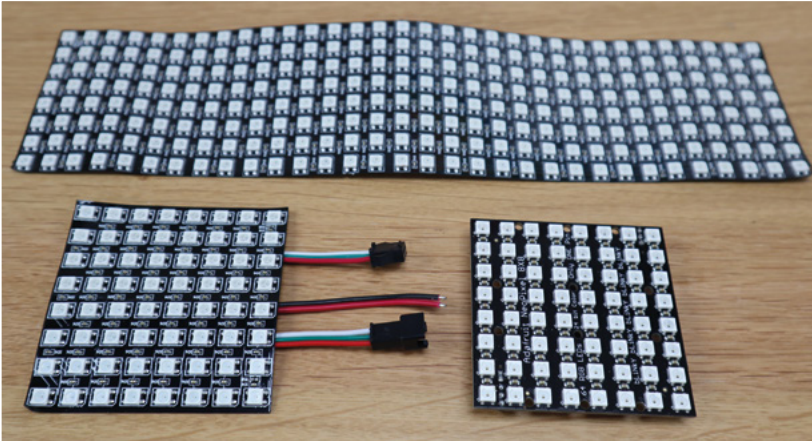

Left ◆
LED matrices come in a range of shapes and sizes

to fit inside my mask, never mind the power supply needed to run it and the matrix. I put the matrix inside the mask, and had wires running out the sides down to my shirt pockets. In one pocket, I had the Raspberry Pi with a USB microphone charged by a USB battery pack and, in the other, a 3 × AAA battery pack to power the matrix. It was a bit of a mess of wires!

A Raspberry Pi Zero W is smaller and more compact, but it would need a micro USB-to-USB adapter and a USB microphone, which adds to the bulk. I also didn't try to put a Raspberry Pi 4 inside my mask or a shirt pocket – due to the heat it is known to produce.

INSTALLING SOFTWARE

Installing the NeoPixel library on Raspberry Pi is a super-easy process. I adapted the Unicorn HAT library from Pimoroni to scroll text across the grid. The initial font was in a rainbow fade, which was awesome (and readable)! You can find the original Pimoroni library here: hsmag.cc/ibeFLX.

In addition, all of the code for all versions of my mask can be found on my GitHub page: hsmag.cc/d7Ohi1.

The Google API Library was easy to connect to, and I was able to get started with the free version. At some point, the free Google API will stop working and you'll

need to sign up for the paid-for service. You can get 60 minutes free per month before you have to pay for it.

I got version 1 working really quickly, and some simple questions were answered pretty fast here.

1. The text scrolling across the mask is very readable, especially if you play around with colours and speed.
2. Accuracy was pretty good, but it didn't handle non-natural sentences very well. For example, 'Welcome to element14 presents' is not a natural sentence. 'Element14 presents' is an online community, but it's not as well-known as something like McDonald's or Microsoft! The Google API just couldn't translate that sentence, no matter how many times I tried.
3. The Google API could hear me fine behind the mask. I printed out what it thought I said on the screen, before sending it to the matrix, and it seemed pretty accurate.
4. It was too slow to transcribe live – it took several seconds between me saying →

Right ◆
The first version ran off a Raspberry Pi 3 Model B

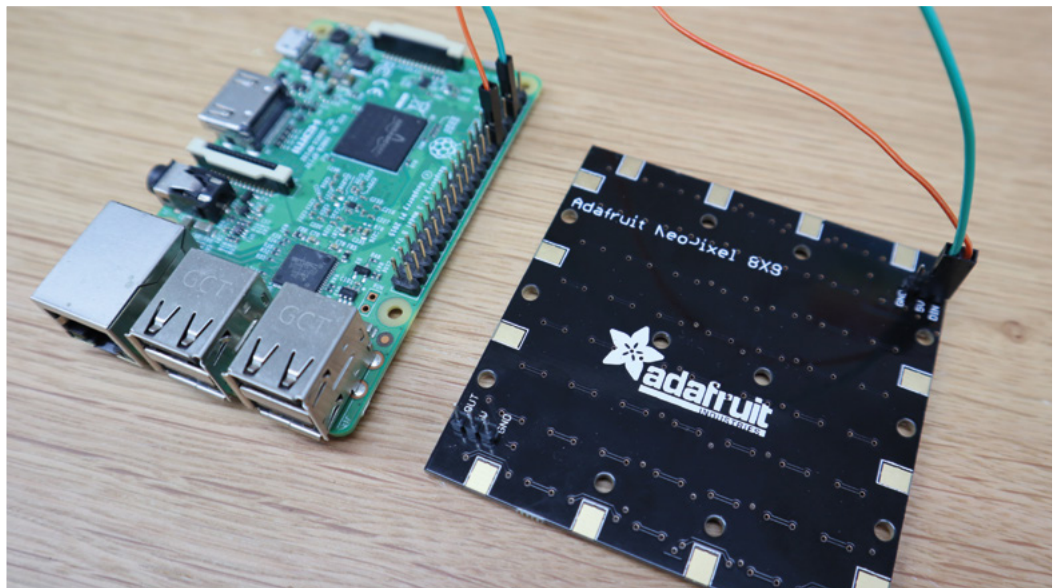

FEATURE



Left
 Before the LEDs light up, it looks like a normal mask

something and it starting to display it on the matrix.

5. For the RGB matrix, I used a solid 8 × 8 NeoPixel grid from Adafruit. This was really uncomfortable to wear inside the cloth mask. I tried a 64 × 8 flexible grid, but this was way too big! I could breathe easily with both, but it wasn't comfortable.

VERSION 2: ESP32 AND DRAGON NATURALLYSPEAKING

I moved quickly on to find a better transcription service and a smaller microcontroller. My husband's work has a

professional paid-for service called Dragon NaturallySpeaking that you can train to your own voice. Wearing a mask, I trained my voice and the transcription was fantastic. It was really fast, it transcribed while I was talking, and it was accurate with any and every sentence I said. My husband is a GP, so the software also had extra features such as medical vocabulary.

I used a program called PuTTY to send the text from the Dragon software,

down, '[' increased the brightness, and ']' decreased the brightness.

The great part about this version was I could use the microphone of the computer, the computer was doing all the processing, and I had almost everything sitting inside the mask.

I used a LiPo battery to power the ESP32 inside the mask, and a 3 × AAA battery pack clipped to the back of my shirt to power the matrix.

I also upgraded to a flexible RGB LED matrix, which was much more comfortable to wear inside the mask

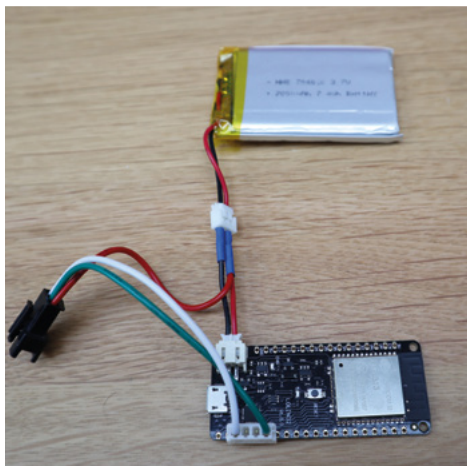

over Bluetooth, to a small ESP32 – a WEMOS LOLIN32 inside the mask. The computer had to have a Bluetooth dongle attached.

The ESP32 was taking the text from Bluetooth and displaying it on the matrix. I added special characters to the code to control the speed of the text. For example, the symbol '>' sent to the mask sped up the speed of the text, '<' slowed it

I also upgraded to a flexible RGB LED matrix, which was much more comfortable to wear inside the mask. One mistake I did make was soldering *all* of the pins onto the WEMOS. All of the pins not connected to wires then stabbed me in the face!

VERSION 3: ESP32 AND A SMARTPHONE

Once we had text coming into the mask from Bluetooth, straightaway I knew I could make this mask better. While version 2 answered all the questions positively, being connected to a computer using a paid-

Left
 The ESP32 controller is much smaller than the Raspberry Pi 3 Model B

Right  The wiring for the final project is pretty straightforward

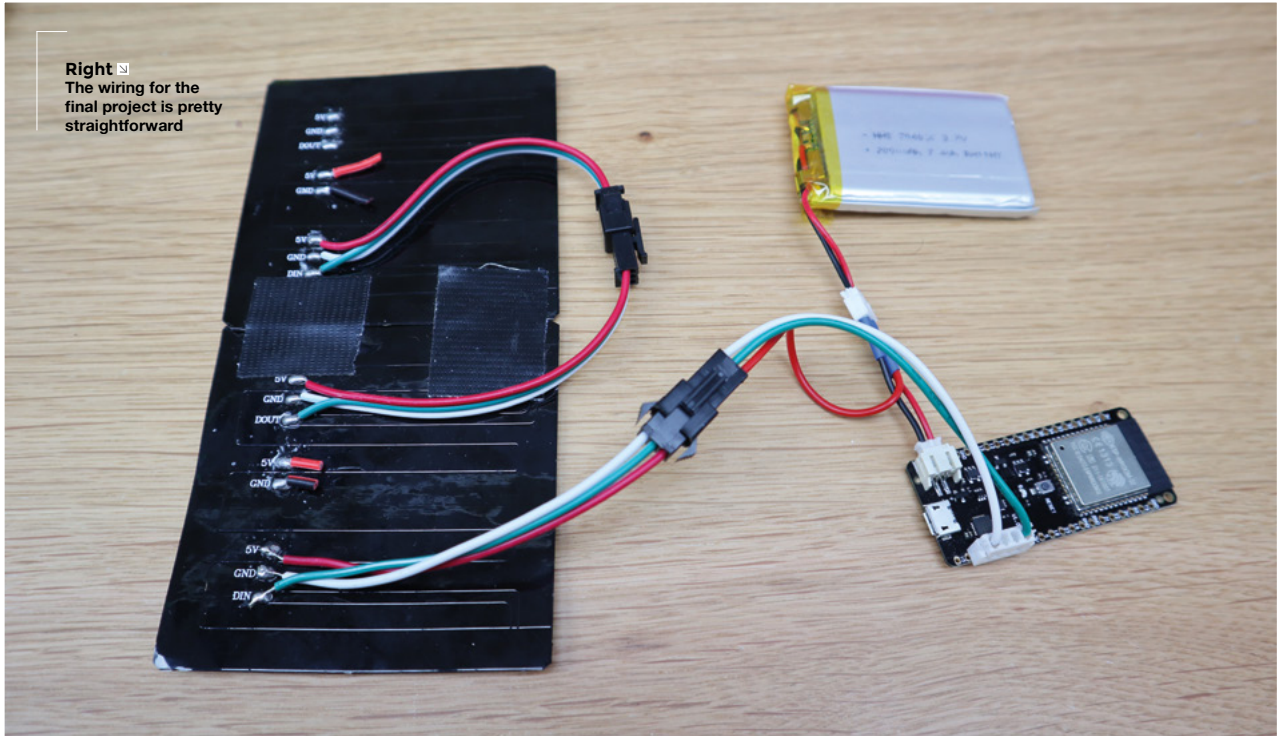

for service was not where I wanted this project to end.

On your smartphone keyboard, there is normally a microphone you can press that will transcribe your speech. On my Android phone, this is a service provided by Google. It's fast and accurate. I just needed a way to get that transcribed text from the phone to the mask over Bluetooth.

There is an app in the Google Play Store called Serial Bluetooth Terminal, by Kai Morich, which does the job really well. But I wanted to adapt it to work better with my face mask.

In his spare time, my husband Phil makes and sells a cave surveying device called the Shetland Attack Pony, shetlandattackpony.co.uk. This is a device that he wanted to get data out of using Bluetooth – so that cavers could access the data live in the cave, without being connected to it through a wire. He spent a lot of time coding Bluetooth connections, so was just the person for the job!

He wrote my new shiny Android app Face Mask Controller: hsmag.cc/YpAzwx. Phil forked the Bluetooth Terminal app and made some alterations. Kai was very kind to give us permission for this. An alteration I wanted was to send the speech as the user spoke. The original app had a button to this. This created a new problem.

When transcribing, Google goes back to the start of sentences and edits them for better accuracy. This happens when you have sentences such as: 'By the puppy was a table'.

Google might think it was 'Buy the puppy'. When it gets to '...was a table', it realises the first word was 'by' and goes >

Right  With two 8 x 8 matrices, you can easily read the text

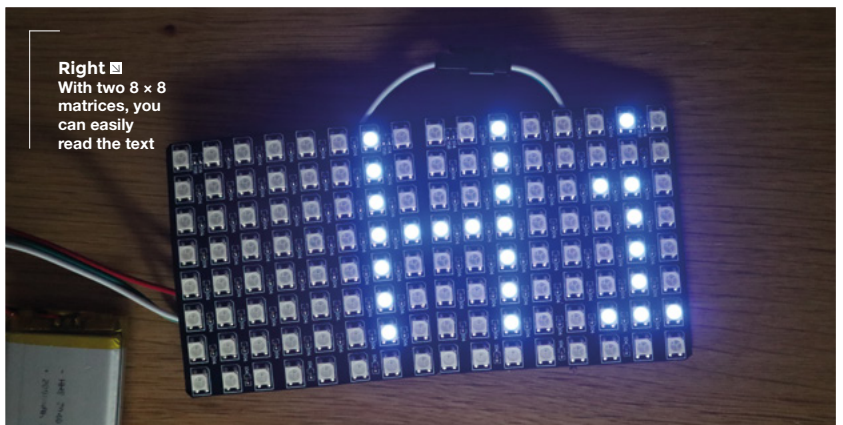

How I Made: A talking face mask

FEATURE



Right ♦
The final mask
up and running

back and changes it. For the mask, because we are sending text as it's transcribed, this meant that 'Buy the puppy was a table', and 'By the puppy was a table' would both scroll. This was very distracting and wastes time.

Phil fixed this by allowing the app to remove characters from the queue waiting to be displayed.

And that was it! With the app sending accurate transcription from my phone, I had a working talking face mask. It was readable, accurate, fast, comfortable to wear, comfortable to breathe while wearing it, and all the electronics now fitted inside the mask.

FURTHER UPDATES

For Version 4, I moved onto one battery – powering the mask and the ESP32 using a flat LiPo battery.

For Version 5, I connected two 8 × 8 grids together for better readability.

And that's where I stopped!

The face mask is now completely mobile.

Using your smartphone, you can walk around and talk to your phone, and the text will scroll across your face mask for people to read. The transcription is now free – cost-free and computer-free.

A fun part of this project is using the Google Speech-to-Text transcription on my Android phone: there is a translate button.

Using your smartphone, you can walk around and talk to your phone, and the text will scroll across your face mask for people to read

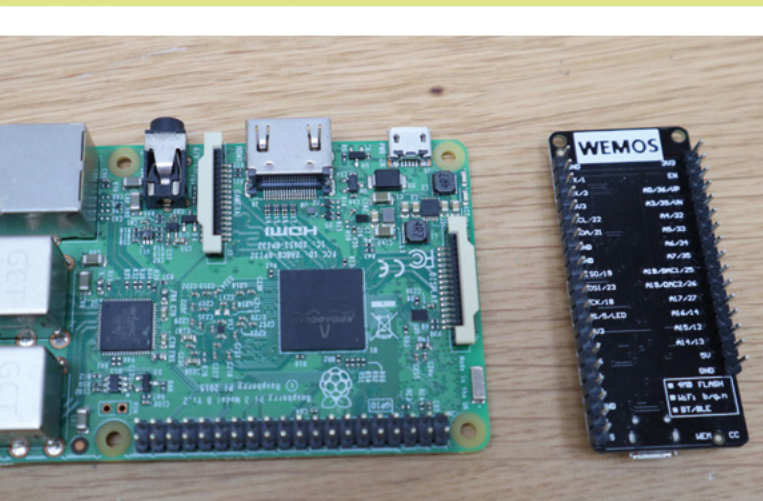

Left ◊ I shrunk the electronics by switching the control board

Right ◊ You need an Android app to control the mask

Below ◻ The app can translate your speech on the fly

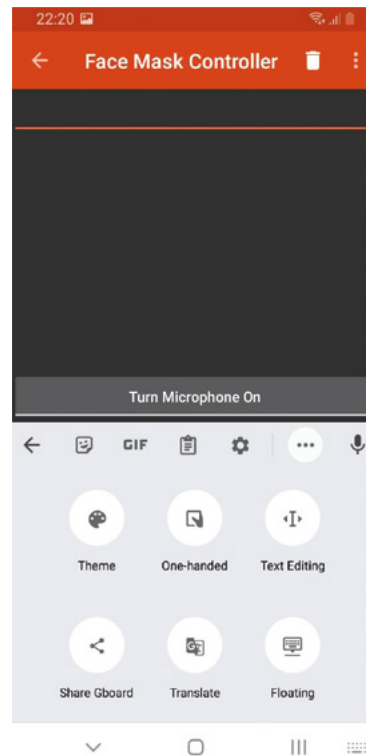

You speak in English into your phone, and it returns any language you choose. I would say 'hello' into my phone, and 'bonjour' would scroll across my mask. How amazing would this be on holiday!

The one disadvantage is you cannot see when the scrolling stops. You can see what the transcription thinks you said on the phone, but you don't know when the text has stopped scrolling on your mask. I use the glare of my phone as a mirror for this!

THE FINAL MASK

By the end, I had two flexible 8 × 8 RGB LED matrices connected together, controlled by a WEMOS LOLIN32, and powered using a LiPo battery.

I made a video of how I created versions 1 and 2 of the mask, which can be found on the element14 Community at hsmag.cc/MSTr8A – note that it's members-only content, so you'll need to start a free membership on the site in order to watch it, but that's well worth doing anyhow. In addition, full instructions of the other versions, including a shopping list, are on my blog – hsmag.cc/IAzbaz.

I had lots of fun with this face mask. It looks more impressive in person than any

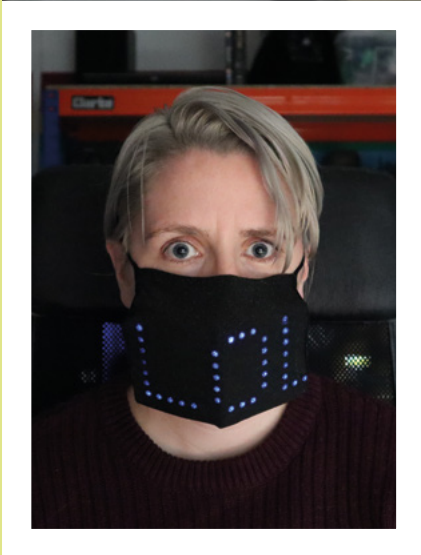

Above ◊ Get your message across, even without audio

camera can capture. Besides the practical use of allowing everyone to understand what you're saying, it's really good fun having an RGB LED matrix on your face! If you have the matrix attached to a good battery, you can swap out the ESP32 for something easy to code, like a micro:bit, and just draw silly faces. ◻

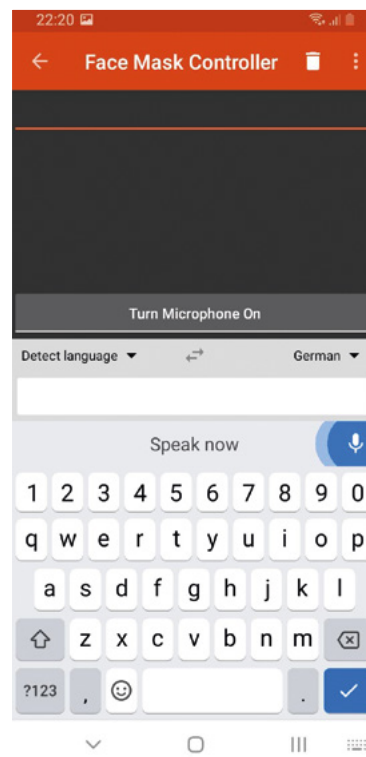

HackSpace magazine meets...

Rob Ives

If you have access to paper, scissors, and Sellotape, you too can be an engineer

If engineering is the art of solving problems, then Rob Ives is one of the best engineers out there: he gives himself an extra problem, which is to build his solutions out of paper. He's an author, a former teacher, and the creator of brilliant paper automata.

We caught up with Rob in the English countryside and found out what it is about paper that's so attractive, and how you go about making money from ideas in a world where ideas are free. →



Left  Rob Ives, complete with lockdown beard, taking a break between paper mechanisms

HS First things first: how did you become a professional paper engineer?

Rob Ives I used to be a teacher, but before that I did a year and a half of an industrial design degree. Weirdly for the title of the degree, it was more about taking functional things and making them pretty, rather than designing things that work, so I decided that it wasn't for me. That's when I went into teaching, and spent ten years as a primary school teacher. I got into making models out of paper to explain mathematical principles to the kids – not just to explain them, but for them to build themselves so that they could understand things better. I still visit schools to talk to teachers and pupils about design and engineering.

I was presenting at a maths teachers' conference, and a publisher who was there happened to see what I'd brought. They asked me if I'd be interested in working with them. The result was my first book, *The Paper Locksmith*. There's this crossover with lock picking, code-breaking, and general geekiness. It's to do with wanting to know how things work; what goes on inside a sealed box. It's curiosity. By their nature, locks have to be secret for them to work, and what's more inviting to a curious mind than that? That led to my second book, *Paper Automata*. Each model in that box uses a different engineering principle to produce motion. That's partly why I call myself a paper engineer.

HS What sort of things do you make?

RI I try to make things that I will enjoy building, and other people seem to like it too. I'm always thinking of new things to try out. The most recent thing I've had a go at is a re-creation of a Lego build by a YouTuber called JK Brickworks. They've done a model of some prairie dogs in a burrow – one's peeking out of a hole, one's wagging its tail, one's moving up and down, and one is moving its head to the left and right. They've used some very nice mechanisms to get all that movement, and I thought I'd have a go at that. →

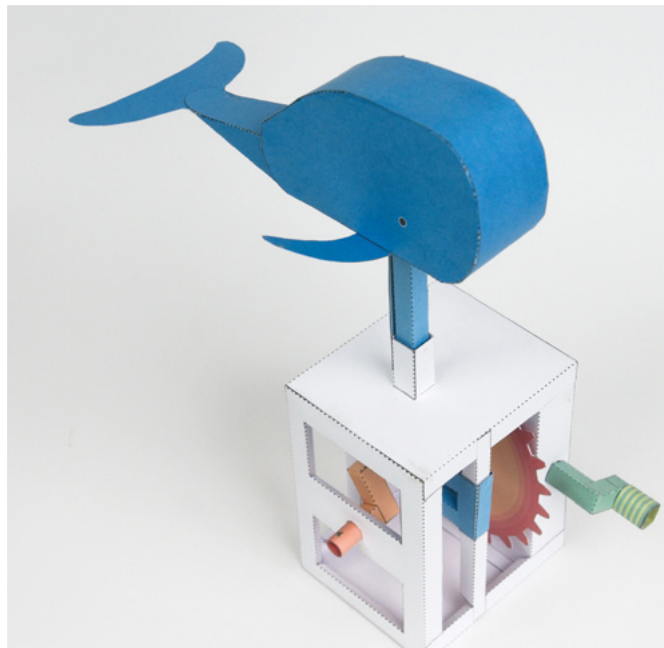

Right ■ This dinosaur of the sauropod family uses a pendulum motion to lower and raise its head



Left  Turn the handle and the lovebirds flirt with each other (the cams underneath each bird are a slightly different size, turning the bird first one way, then the other)

Below 
You can probably guess this, but the disagreeable sheep shakes its head

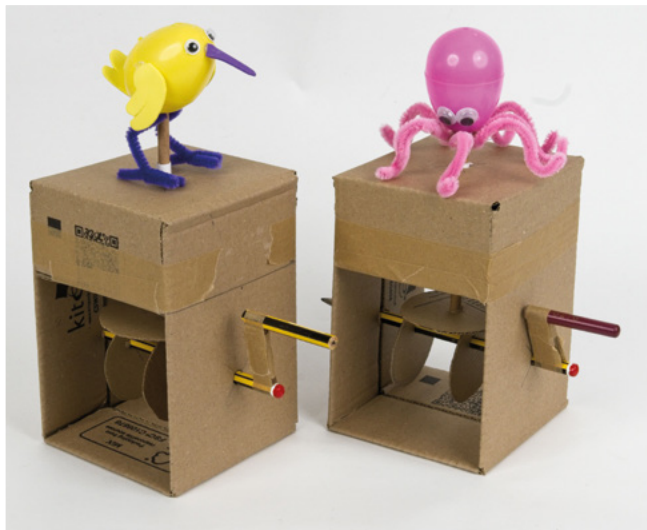



It all comes down to the mechanisms and what you can do with them. I've got a section on my website for mechanisms, to show the ways you can transform one type of movement into another kind of movement. Different types of cranks, gears, cam systems, rack and pinions... when you add a bit of imagination to those basic mechanisms, you can make anything, or almost anything. That's where the hard part comes in.

HS Why paper?

RI I'd been a teacher for about ten years. Obviously you can't give primary school children woodworking tools – I can't see it going down at all well at parents' evening if kids are coming back covered in cuts. But paper is different. It's cheap, for one, and if you use scrap paper to prototype or to sketch out designs, it's virtually free. Once kids are dexterous enough to cut along a line with a pair of scissors, they're perfectly capable of making whatever they can imagine out of paper.

I also like the fact that paper has limitations. You have to work within the constraints of the material. So if you think of a mechanical system, such as a cam or a lever, or you want something more advanced like a Geneva drive, the first question I have to ask myself is, can I do this in paper? It's a constant challenge, but that's what engineering is.

HS Do you put paper designs in the post to customers?

RI When I started out, I was printing out designs at home and putting them in the post to customers. The interest was out there, but by the time you factor in the time it took to get things printed, plus the

packaging, plus the postage, it became obvious that it was going to make more sense to sell the designs, rather than a physical product.

HS Don't people just copy your designs anyway without paying?

RI It's funny, one of the publishers I've worked with a while back was very keen to avoid piracy. They put a lot of effort – a disproportionate amount of effort – into making sure that nobody pirated any designs, with all sorts of digital rights management. It was a very big deal. And it didn't make any sense to me, because from a commercial point of view, I'm only interested in one kind of person: the person who's interested in my work and is willing to pay for it. If you're willing to

pirate my work, you're not the sort of person who's going to pay for it. And if you are going to pay for it, there's no point making you jump through hoops, making you feel like a criminal.

You don't need everybody to like your work, but you do need a small number of people to love it

It comes back to the question of who your audience is. I've been quite influenced by Kevin Kelly's essay *1000 True Fans*. The gist is that you don't need everybody to like your work, but you do need a small number of people to love it.

The number he chose is 1000, which keeps the maths simple. If you have 1000 people who buy everything you create, and you make £50 per year off each one, of these True Fans, that's £50,000 a year, which is a good living. You'll make other sales along the way, because there are plenty of other people out there who might buy one or two things, but not everything. But the True Fans are the ones who are going to pay your mortgage, and they're also the ones who will evangelise for you, so they're the people you need to target. →

In the olden days, when you needed an intermediary like a publisher, or an art gallery, or a record label, it would have been hard for everybody to find their 1000 True Fans, because they'll focus on the big sellers at the expense of the smaller creators. Those 1000 fans might have been spread all across the world. One in London, one in Adelaide, one in Chicago, ... they'd never have met, and no bookshop would ever have found them because it wouldn't have been worth it.

But we've got this wonderful thing called the internet now, so the 1000 people who buy your work could be anywhere, and you can reach them just as well as if they were in the same town.

In a way, we've come full circle. In the even older days, before record companies etc. existed, musicians had to go from place to place and have direct contact with fans. I get feedback from all over the place on things I've done, which wouldn't happen if I were just in bookshops.

There's also a book called *The Curve* [by Nicholas Lovell] that's influenced me when it comes to things like pricing, what to give away, and what to charge for. In the olden days, businesses had to make an educated guess about the average price that people would pay for something, whereas now they can segment an online audience and work out who will pay more for something. It's hard work selling things on the internet, but at the end of the day, I can make whatever I want.

HS What sort of feedback do you get?

RI Mainly I get photos of the projects that people have made. I get a ding on my phone, and someone has put a photo of one of my projects that they've made on Twitter and tagged me in. It's a brilliant feeling.

My projects have been on television too: someone on Belgian TV made a life-sized cardboard Tyrannosaurus rex off the back of one of my designs, which was pretty surreal. It was in Dutch, so I didn't understand what was going on, which made the whole experience even more surreal than it would otherwise have been.

Another of the models has also been on Belgian TV – the dancing man. These two blokes set up a life-sized model in a shopping centre and invited the public to have a go turning the handle to make the model dance. They had to change the design slightly to scale it up because, eventually, corrugated cardboard will bend under its own weight, but I was pretty pleased with how well the basic design held up. It had to be strong enough to resist the general public ragging it one way and the other, and barring a little extra Scotch tape, it held up OK. They dressed it up as an aerobics instructor and had it leading a crowd in the shopping centre in a dance routine. And they stuck [Belgium and Real Madrid goalkeeper] Thibaut Courtois's face and a pair of gloves on it, and had people fire footballs at it.

I keep track of the downloads I get, and at one point I realised that I had had downloads from every continent on the planet, apart from Antarctica, which was pretty cool. Then someone at one of the research stations in Antarctica downloaded a book, so that tipped things into global phenomenon territory.

HS What are you working on right now?

RI I'm playing with 3D printing for the first time. I'd been wondering for a while about whether it's possible to build a 3D-printed clockwork mechanism – it turns out that not only is it possible, but the PLA I've printed the spring out of is nice and springy, and is a decent store of energy. I've had to learn Fusion 360 to do this, so that's been a massive learning curve in itself, but once you're away, there's so much that you can do with it. Just like paper, there are limits with what you can do when you're designing for 3D printing, so that's all part of the fun.

And, I'm still writing books – the latest one that's out is a collection of things to make that you might find in a typical workshop or makerspace, and it's called *Build It! Make It!* Apart from that, I'm going to keep doing what I always do: try to make things that I enjoy building. If other people like them too, that's a bonus. □

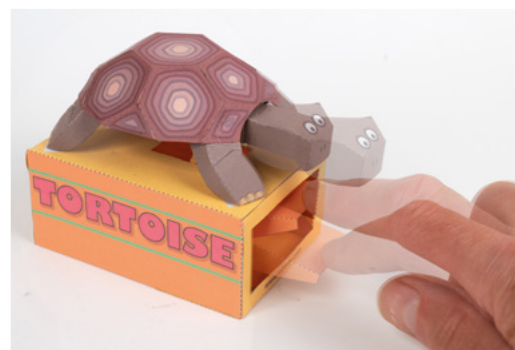
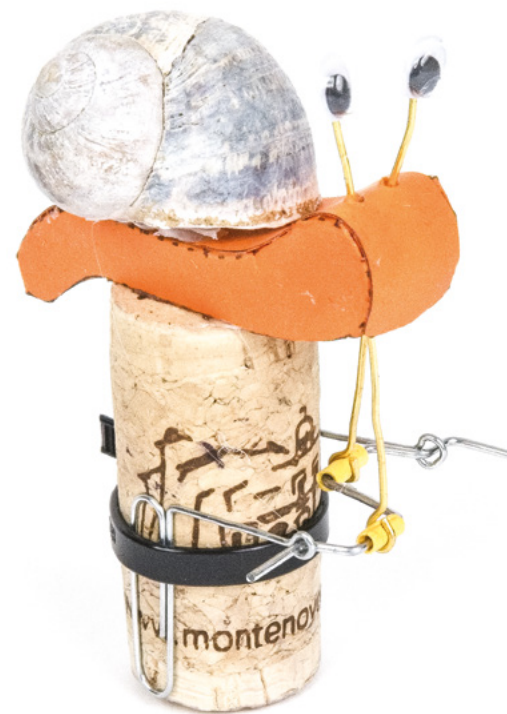

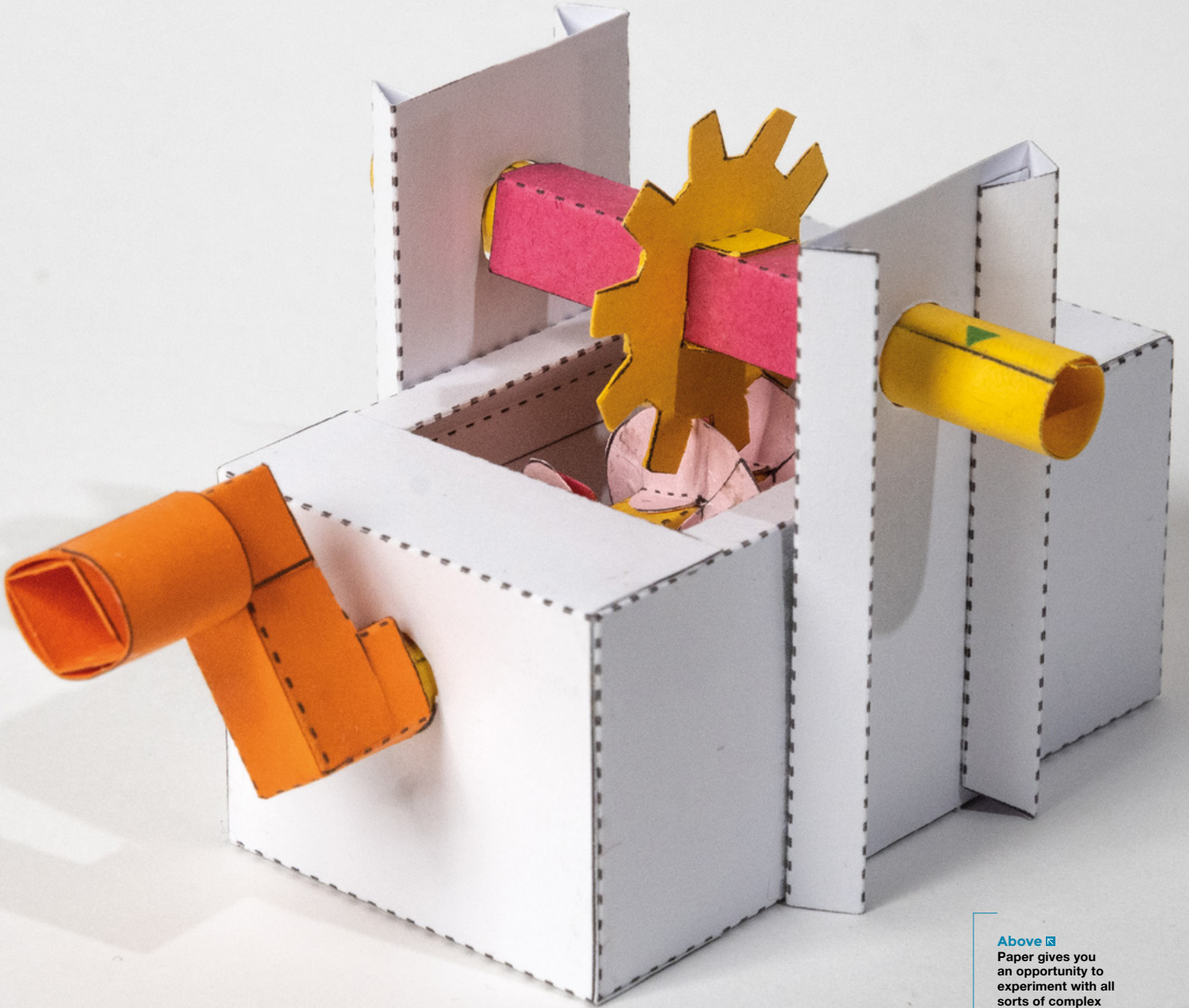

Above  Paper gives you an opportunity to experiment with all sorts of complex mechanical designs



CARDBOARD

A box of tricks



Mayank Sharma

[@geekybodhi](#)

Mayank is a Padawan maker with an irrational fear of drills. He likes to replicate electronic builds, and gets a kick out of hacking everyday objects creatively.

You don't need us to tell you that a cardboard box is one of the most popular choices for packaging.

It's lightweight and durable, which is everything anyone needs from a packaging material.

In some form, cardboard can be traced back to 17th-century China. It took another couple of hundred years for our beloved packaging material to reach Europe in the 19th century.

British industrialist Sir Malcolm Thornhill is often credited for producing the first commercial cardboard box in England in 1817, though his boxes weren't anything like the folded boxes we use today.

It wasn't until the late 1870s, that Robert Gair invented the familiar creased cardboard boxes, across the pond in the United States. He got the idea from an accident at his factory that made him realise that, by cutting and creasing cardboard, he could make prefabricated cartons without much effort.

The popularity of cardboard grew rapidly as soon as people realised that it was malleable enough to be formed into various shapes, yet sturdy enough to hold a fair amount of weight. Kellogg's was one of the first to commercially use cardboard to package their cereal at the start of the 20th century.

By some estimates, the cardboard industry in the United Kingdom is worth over £4 billion, and employs around 30,000 people. Old industry figures say that

Brits use about five billion corrugated boxes per year, although we are sure that number must have significantly gone up in recent years.

That's not a bad thing, when you consider the fact that corrugated cardboard boxes are the most environmentally friendly packaging material on the market.

You can recycle cardboard with only about 75% of the energy it takes to make a new box. The recycling process also produces half the amount of sulphur dioxide that's released when making a box from scratch.

No surprise then that corrugated cardboard has the highest recycling rate of any packaging in the world. And a significant majority of all cardboard packaging recycling is done here in the UK. In fact, chances are that the cardboard boxes that you have lying around were made from reused materials.

Cardboard is not just a wonderful packaging material, but it's also robust, which makes it perfect for intrepid DIYers. In 2004, Australian architect Peter Ryan built a house that could be lived in, made entirely from cardboard boxes. And in 2015, Japanese automaker Toyota used 1700 individually shaped cardboard sheets to create a fully functional replica of its Lexus IS luxury sedan!

Flip over the next few pages to see some less involved, but amazingly useful builds fabricated from cardboard.

HAND SANITISER MACHINE

YouTuber **Mini Gear** seems to have a love for building things with cardboard.

We particularly like his hand sanitising sprayer project, which makes for a very useful gadget in these strange times. The build involves a handful of different-sized pieces of cardboard that are cut, stripped, and glued to make the contraption. In the video of the build process, he has shown the entire construction in detail and has very helpfully marked the dimensions of the cardboard sheets he's working with, to make it easier for anyone to follow. The best bit is the spraying mechanism. He's wired a bunch of DC motors to a speed controller that activates levers to translate the rotary motion into lateral movement (the levers have been beautifully fabricated from ice cream sticks). We also love the attention to detail: he's even made flap windows to easily access the sanitiser bottles when they need to be refilled. To use the device, you first select the speed of the motor, and then press a button to activate the circuit. For dramatic effect, he uses a handful of LEDs that light up when the sanitiser is sprayed. →

Project Maker
MINI GEAR

Project Link
hsmag.cc/GYAc7v

"THE LEVERS HAVE BEEN BEAUTIFULLY FABRICATED FROM ICE CREAM STICKS"



Right ⇨ Stop by Mini Gear's YouTube channel for hundreds of similar projects fabricated from cardboard

BED TABLE

Project Maker
**LINDA
BELLOSKI**

Project Link
hsmag.cc/SFamBI

Although Linda doesn't use her tablet much, she decided to build a multi-purpose bed-stand for her mother who had a hard time trying to use the gadget while in bed. Linda, who loves to upcycle, decided she'd make a bed table with cardboard. Inspired by another maker's 3-in-1 table made from wood, Linda made hers multipurpose as

well. The base of the table is made with three layers of thick corrugated cardboard, while the feet are cut from cardboard tubes. She's also cut some discs to stuff inside the tubes, placing some much closer to one of the openings in the tube than the others. These act as the base for anything you want to put inside the tube, such as a mobile phone, or a bottle

"YOU CAN USE THE FOUR FEET TO HOLD STATIONERY, GADGETS, OR ANYTHING ELSE YOU NEED"

of water. She's then fabricated a stand for the tablet as a removable tray. Underneath it is the surface for the laptop, in which she's very thoughtfully poked some holes for the laptop to dispense the hot air. The finished product looks very neat, and you can use the four feet to hold stationery, gadgets, or anything else you need while using your computer or tablet.



Left ⇐
Linda suggests you apply a sheet of plastic on both the trays of the table to make it easier to clean

STEERING WHEEL

An electronics and communications student in the Philippines, Angelo decided to enhance his tablet gaming experience by hacking together a gaming wheel. He's used a plastic plate as the steering wheel, while a bunch of PVC pipes make up the steering mechanism. The entire rig is mounted on a cardboard box that's weighed down with sand. Angelo wanted to use a tablet case to mount the tablet, but instead decided to build one using some cardboard. He's very cleverly used some yarn to build a pulley to synchronise the movement of his plastic plate steering wheel with the cardboard tablet holder. The build sounds more complicated than it is. The only critical step, according to Angelo, is to make sure the yarn pulley has enough tension to ensure there is no lag between the movement of the steering wheel and the tablet.



Project Maker
ANGELO CASIMIRO

Project Link
hsmag.cc/8O99qG

Left ◊
Angelo suggests you can also brake with the rig with the help of a small Bluetooth controller glued to the steering wheel

BODY ARMOUR

By day, Rachel is the mild-mannered manager at a CNC cutting and fabrication service in California. By night, however, she's a member of a fighting league that like to bash each other with weapons made from...cardboard. The Cardboard Tube Fighting League organises duels between its cardboard tube wielding members. It was for one such competition that Rachel decided to create herself armour from, what else but, cardboard. She spent some time trying to understand the various components that make

up armour, before fabricating them using quite a few pieces of cardboard. Despite having a fair bit of experience making clothing, working with the stiffer cardboard was a different experience. Rachel has detailed the process of creating each and every component of the armour, which are then assembled using duct tape. The cardboard armour has served its purpose very well, and helped Rachel score a runner's up spot in the competition. ◻

Project Maker
RACHEL

Project Link
hsmag.cc/xUoQsS

Below ◊
Add some accentuating elements, like spikes and a healthy dose of silver paint, and you've got yourself a Halloween costume



8 tips for turning an IDEA into a BUSINESS

By Matt Bradshaw

Having an idea and then being able to make it from scratch is one of the most rewarding aspects of being a maker, but have you ever wanted to go a stage further and sell your creations to the world?

This year I took the plunge for the first time, and have started selling drum machines online. It's been a voyage of discovery, and I've written some tips based on what I've learnt along the way. For reference, the product I designed mainly consists of simple electronics and laser-cut plastic, and is assembled by hand, but hopefully some of these tips will be helpful, regardless of what you're planning to build.

1) Have a good idea

This one might seem obvious, but you're going to need a good idea for something to make. It should be an idea that you are excited to work on, because designing a product to sell takes a lot more effort than designing something just for you, and you'll want to remain motivated all the way through the process, including after the launch!

If you find an idea that you really want to work on, then chances are that other people will want to buy it. If it's your first commercial project, though, you may also want to choose an idea which is not too ambitious. I rejected a few potential ideas for being too complex, and I'm now very glad I did.



Above ♦ You don't need an expensive storage system for your parts, but it's worth spending time to get it right

2) Do some early planning

Before you sink too much time into the design process, try doing some back-of-the-envelope calculations. Roughly how much will the components and materials cost for each product? How long do you think it will take to make each one? How much will you charge?

If you're looking to make a decent income from your idea, work out how much you'll end up getting paid per product you sell, and per hour you work. You could also factor in an estimate of your development time, because ideally, you want to be paid for this as well as the time spent assembling your creations.

Try plugging in some different numbers – would you still make enough money if you had to sell the product for less money, or if the components later turned out to cost more? Even if it's a passion project and you're not too worried about making money, at least make sure you can break even!

3) Consider making your project open-source

While you're still at an early stage of your project, think about whether you could make the design available under an open-source licence. Doing this is obviously really helpful for other makers who might want to study or reproduce your design, but it also has benefits for you. When you know that other people might look at your schematics or source code, it makes you produce a tidier project, particularly when you're writing code (comments are always a good idea!).

I also found that by sharing my progress as I went along (on the Hackaday.io website), I cultivated a small but enthusiastic community of followers, who were among the first people to buy one of my drum machines on launch day. Of course, if you are considering patenting your idea, or if you are particularly worried about your design being copied, you can keep it under wraps, but it's worth bearing in mind that open-sourcing your project does have numerous benefits. Some makers also compromise by choosing to open-source their projects a while after release. →

Item	Quantity	Unit cost (GBP)	Total cost (GBP)	Supplier	Link	Last count	Stock
DrumKid PCB	1	2.5	2.5	JLPCPB		40	18
Battery box (3xAA)	1	0.67	0.67	RS	https://uk.rs-online	137	115
Female header, 15x1	2	0.23	0.46	LCSC/BitsBox		660	616
MIDI socket	2	0.6	1.2	Mouser		560	516
EG1206 slide switch (SPDT)	2	0.5	1	Mouser		560	516
DIP socket (8 pin)	1	0.05	0.05	RS		164	142
6N138 optoisolator	1	0.35	0.35	RS		80	58
1N5817 diode	1	0.02	0.02	RS		435	413
1N4148 diode	1	0.02	0.02	RS		275	253
Resistor (220)	3	0.1	0.3			525	459
Resistor (470)	1	0.1	0.1			130	108
Resistor (680)	6	0.1	0.6			1000	868
Resistor (10k)	1	0.1	0.1			780	758

Left ♦ Keeping track of how many components you have makes life easier



Above ♦
Launch day can be a lot
of work!

4) Get other people to test your prototypes

Once you've built a prototype you're happy with, it's tempting to think that you're ready to start ramping up production, but one of the most important lessons I learnt while working on my drum machine was that it's vital to get some outside input first. It's really hard to imagine all the different environments where your creation might be used, but giving prototypes to friends (or strangers!) to test will instantly highlight various issues before they become a bigger problem. For instance, I had never tried using my drum machine in a dark room, so I was surprised to receive an all-caps text message from a friend which simply read 'MY EYES' – it turned out that the flashing LEDs were too bright, which was an easy thing to fix at the prototype stage.

**“Don't be afraid
to change your
original design”**

5) Make your idea easy to build

This next tip is important if (like me) you're going to be assembling your products by hand: try and make the design as easy to build as possible. Remember that you're not just designing with the end-user in mind, but also the assembler! For me, this meant clearly labelling the circuit board with resistor values, widening the holes for certain components which were a tight fit, and switching to a different brand of pin sockets which were easier to solder. While these minor details don't tend to matter for one-off projects, they're absolutely worth thinking about when you're going to be doing a lot of repetitive work, and can be gradually improved over time as you look to speed up your build process. Additionally, if you're looking to sell your idea in kit form, making the build process easier is arguably even more important.

6) Manage your components

When you're making one-off awesome things, you tend to buy components in small quantities from wherever is most convenient. When you move into production mode, you'll need to up your game! Firstly, where possible, you should try and choose components that are relatively common and not likely to be discontinued. If your whole design depends on a niche item from a single random eBay seller who could stop stocking them at any time, you may want to reconsider. If all the parts your project needs are available from various well-known retailers, that's a good sign, and if you can buy all your components from one place, or from as few different places as possible, then that will make life a lot easier.

Secondly, if your project has more than a few components, make a spreadsheet to keep track of how many of each one you've got. I set up a colour-coding function so that I can see when I'm running low, which means I can see at a glance whether I need to do some shopping.

Thirdly, try to keep all your parts well-organised. I found that once I was regularly making batches of my product, it was absolutely worth building a dedicated storage unit so that I could have easy access to all the components during assembly. Mine was made from scrap plywood and plastic takeaway boxes, but you can also just search online for 'storage bins'.



7) Pay attention to the ordering process

There are many places you can sell your product (Etsy, Tindie, your own website, physical shops, etc.), and each has its pros and cons. My main tip, though, is to set up a process that is as painless as possible for you. I use Shopify, a website/app which makes it easy to take card payments, and can be linked directly to the Royal Mail 'Click & Drop' system. This means that my phone alerts me when someone orders a drum machine, and I can then print a shipping label from the Click & Drop website. Once I've dropped the parcel off at the post office, I can mark the parcel as 'dispatched', and Shopify automatically sends a confirmation email with tracking info to the customer.

Little bits of wasted time add up quickly when you're selling regularly, so try and optimise your routine wherever possible. If you can get your creation into a package small enough to fit in a postbox, you can save yourself time by not having to queue at the post office. There are also some parcel services that will collect from your home, which could be worth investigating.



Left ⇄
Assembling your product in batches can be quicker than making one at a time



8) Be ready to change the design

However much you test your product before launch, issues may arise later, and there are various ways you can take this into account. I only made a small number of units to start with, just in case there were any problems, and then expanded production once I started getting positive feedback. I made sure the firmware could be updated by the user so that I could implement minor improvements and new features remotely.

I also gradually improved the circuit board design over the course of a few months, making minor alterations to the quality of the output signal. Basically, don't be afraid to change your original design if you think you can make it better! □

Left ⇄
Making the same thing repeatedly can be tedious, but if you pick a good podcast to listen to, it can also be relaxing



The
MagPi

HackSpace
TECHNOLOGY IN YOUR HANDS

CUSTOMPC

3 ISSUES FOR £10



FREE BOOK



hsmag.cc/hsbook

Subscribe to The MagPi, HackSpace magazine, or Custom PC. Your first three issues for £10, then our great value rolling subscription afterwards. Includes a free voucher for one of five fantastic books at store.rpiexpress.com/collections/latest-bookazines
UK only. Free delivery on everything.

FORGE

HACK | MAKE | BUILD | CREATE

Improve your skills, learn something new, or just have fun tinkering – we hope you enjoy these hand-picked projects

PG
76

RASPBERRY PI RFID

Send data to your
Raspberry Pi with just a tap



PG
78

HOME AUTOMATION

Let the machines take over

PG
82

ROTARY LASER CUTTER

Spit-roast designs onto
cylindrical objects

PG
86

FREECAD

Design your own wheels



PG
92

FOUND SOUND

Take to the streets to make music

PG
72

SCHOOL OF MAKING

Start your journey to craftsmanship
with these essential skills

72 Restoration

74 Printing in CPE



Restoring old parts

Give your worn and battered companions a new lease of life



Gareth Branwyn

🐦 @garethb2

Gareth has been a lifelong practitioner (and chronicler) of DIY tech, media, and culture. He is the author of ten books, including *Tips and Tales from the Workshop*, and is a former editor for *Boing Boing* and *Wired*.



There's something oddly satisfying and therapeutic about taking something old and forgotten, something previously reliable, now seized with time, rust, and neglect, and lovingly restoring it back to productive use.

This process can be very rewarding – a fun challenge – and you end up with something useful, something with a history and a renewed purpose that you rescued from the bin.

Here are some tips and tool recommendations for getting started in tool restoration.

Online manuals for your tool You can find the service/repair manuals to an astonishing number of old tools and machines online. To find one related to your tool, do a web search or look at sites like vintagemachinery.org. They have old service

manuals, technical drawings, vintage tool catalogues, and more. These manuals and drawings can be very helpful in understanding an old tool, taking it apart for cleaning and repainting, and putting it all back together.

Lead paint testing If you're going to be removing paint from old tools, you'll want to know if the paint you're dealing with is lead-based. You can get test swabs relatively inexpensively online that turn a certain colour to alert you to the presence of lead.

Rust-removing formulations It seems as though Evapo-Rust is the go-to brand of commercial rust remover. It's a chelation agent, a synthetic iron molecule suspended in water. The chelation process forms a bond with the rust and holds it in solution. Evapo-Rust is popular because it is environmentally safe and is extremely effective. A somewhat cheaper

Above 📷
This author restored this hammer as a gift for his partner



alternative is citric acid. See this TRG Restoration video where they test out a number of commercial and home recipes for rust removal: youtu.be/TE9XiVbWumQ.

Alternatives to WD-40 This penetrating oil does a great job, but has some downsides. It's not as cheap as home formulations and it's not so environmentally friendly. One alternative is a mixture of four-parts charcoal lighter fluid, four-parts mineral spirits, and one-part lightweight motor oil. Keep it in an airtight container or it'll evaporate. Other people swear by a 50/50 mix of acetone and transmission fluid.

Cleaning pitch from blades If your restoration project involves an old blade covered in a lot of pitch, clean it in a mixture of boiling water and baking soda.

Cleaning rusted surfaces If you have rusty metal tables on old machinery, you can remove a lot of the rust by soaking rags in vinegar (or citric acid or Evapo-Rust) and letting the rags saturate overnight before cleaning with a wire wheel, brush, or similar.

Take pictures of your disassembly process When taking apart a tool or machine for cleaning and restoration, use your phone to record the disassembly process. That way, you'll have the photos to refer back to if you forget how everything goes back together.

Use tape or Styrofoam to organise and ID parts During disassembly, keep screws and other hardware organised and secure by placing them on a wide piece of masking tape, or poke them into a scrap piece of Styrofoam. You can also write on the tape or Styrofoam what the parts belong to.

Freeing frozen bolts and screws If you have frozen bolts or screws that you can't mechanically remove, a blast with a blow-torch will often give them a thavv.

Making your own japanning This black tool finish is commonly found on hand planes, antique sewing machines, and other older tools. There are many different recipes for making your own japanning. On Hand Tool Rescue (youtu.be/SBqgpdBnr8), Eric tested a number of formulae and ended up

recommending a mixture of 50% turpentine, 30% asphaltum/Gilsonite, and 20% boiled linseed oil. See the video description for details on the full recipe.

Recreating serial number plates Eric also has a clever way of recreating serial number plates. He first punches the original serial number into metal foil tape using a number punch set. Then, he prints a replica of the original label onto clear adhesive label paper and affixes that over the foil. Cut out and apply. See him make such a label: youtu.be/zGM6Dh3V-FM.

When to oil, when to grease? When putting a tool back together that requires lubricant, the question is often what to oil and what to grease. The rule of thumb is to grease hard-to-reach and -maintain places because grease will stay in place longer. Use oil on areas where regular maintenance is not a problem. Grease has a tendency to collect swarf, so oil is better in situations where a lot of material is going to collect.

MUST-SEE RESTORATION TV

Restoration videos are all the rage on YouTube these days. Here are some favourite channels:

Hand Tool Rescue Eric is the king of restoration comedy. He takes great care in what he does, offers tons of tips on how he restores, and he's not afraid to show his mistakes and trial-and-error process.

TRG Restoration This channel is all about bringing old toys back from the brink.

Salvage Workshop Tools, machinery, and heavy equipment restoration.

My Mechanics Tool restorations and re-creations. □



QUICK TIP

If you get serious about doing tool restoration, consider getting a benchtop sand-blasting cabinet. You can get a cheap one at discount tool suppliers like Harbor Freight for just over \$100. You can use sand-blasting to quickly remove paint and other finishes from old tools.

Above

The colourful stages of rust removal

Below

Make your equipment look as good as new with a serial plate

YOU'LL NEED

- ◆ Wire brush (a wire wheel is optional)
- ◆ Dremel-type rotary tool (optional)
- ◆ Citric acid, Evapo-Rust, or similar rust remover
- ◆ Paint stripper
- ◆ WD-40 (or similar penetrant)
- ◆ Old tool service manuals
- ◆ Software and hardware for generating replacement labels
- ◆ Wrenches and screwdrivers (as needed)
- ◆ Impact wrench (optional)
- ◆ Paints and lubricants

Copolyester

Strong and easy to print



Ben Everard

[@ben_everard](#)

Ben's house is slowly being taken over by 3D printers. He plans to solve this by printing an extension, once he gets enough printers.



Right You'll be able to see the infill in transparent parts. This may or may not be a good thing, depending on your design

C **PE or copolyester is a tough, transparent plastic.** Chemically, it's similar to PETG, but it's got a bit extra in the form of a monomer. We've had fantastic results with printing with CPE. The Fillamentum CPE on test has printed excellently, without modifications to slicer or print settings on our test Prusa i3 MK3S. We had excellent layer adhesion, very little warping, and really good-looking prints.

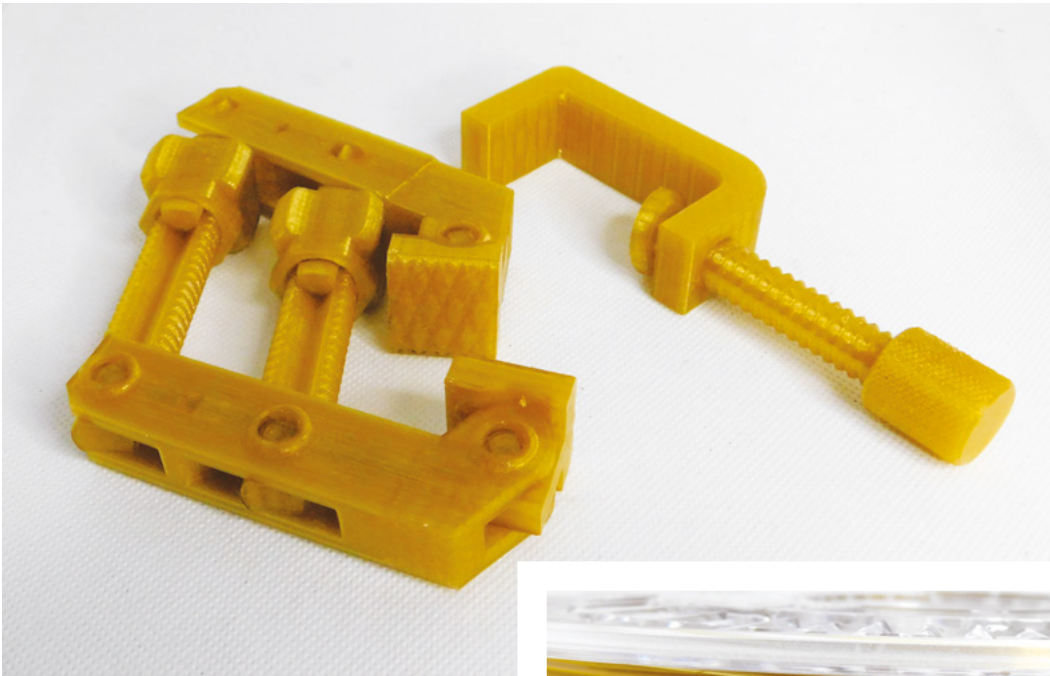

Left ♦ Some clamps we've printed out to test 3D-printed tools

Below ♦ Filamentum Morning Sun is slightly transparent, and looks great with light shining through it



The only problem we had with CPE was getting it off the print bed. It sticks extremely tightly. We had to use glue stick on a flexible PEI print bed. If you miss a bit, it can be quite a challenge to get it off the print surface while minimising damage.

Of course, this printability comes at a cost. CPE is typically about 1.5 – 2 times the price of PLA, so it may not be something you want to use for everyday prints (also, see box on the environment).

// If your printer can handle it, and it's suitable for your model, CPE can produce great-looking, long-lasting parts

The big potential issue with CPE is the print temperature. The working temperature is 255–270°C (we printed at 260°C). This range of temperatures isn't possible on PTFE-lined hot ends found on many consumer 3D printers. Even if your hot end is capable of heating up to that temperature, it can degrade the PTFE, which releases some pretty toxic chemicals, so do make sure your hardware is up to it before cranking up the temperature. Because of this, we weren't able to test it in a range of 3D printers.

If your printer can handle it, and it's suitable for your model, CPE can produce great-looking, long-lasting parts. Printing with this plastic is a worthy addition to your 3D printing skills. □

THE ENVIRONMENT

We live in a world where plastic waste is a huge problem, not just for us, but for our children as well. We should be conscious of the effects our materials have on the planet. CPE isn't particularly toxic, but is a long-lived plastic, so whatever you make with it will survive on this planet (or at least the plastic used to make it will) far longer than you will. This isn't necessarily a bad thing – if the objects that you're printing will offset other waste, or be useful for a long time, it can be a sensible trade-off to make.

However, it's worth considering that one major alternative – PLA – is a bioplastic. While this doesn't mean you can just discard it in nature, you can dispose of it safely. In industrial composting facilities (or possibly suitable home hot composting), it will break down. Do check your local waste advice before disposing of it, though.

Read RFID and NFC tokens with Raspberry Pi

Add a bit of security to your project or make things selectable by using different cards. PJ Evans goes contactless



PJ Evans

@MrPJEvans

PJ Evans is a developer and wrangler of the Milton Keynes Raspberry Jam. He runs a LoRa gateway, which is probably the nearest he'll get to his own radio breakfast show.

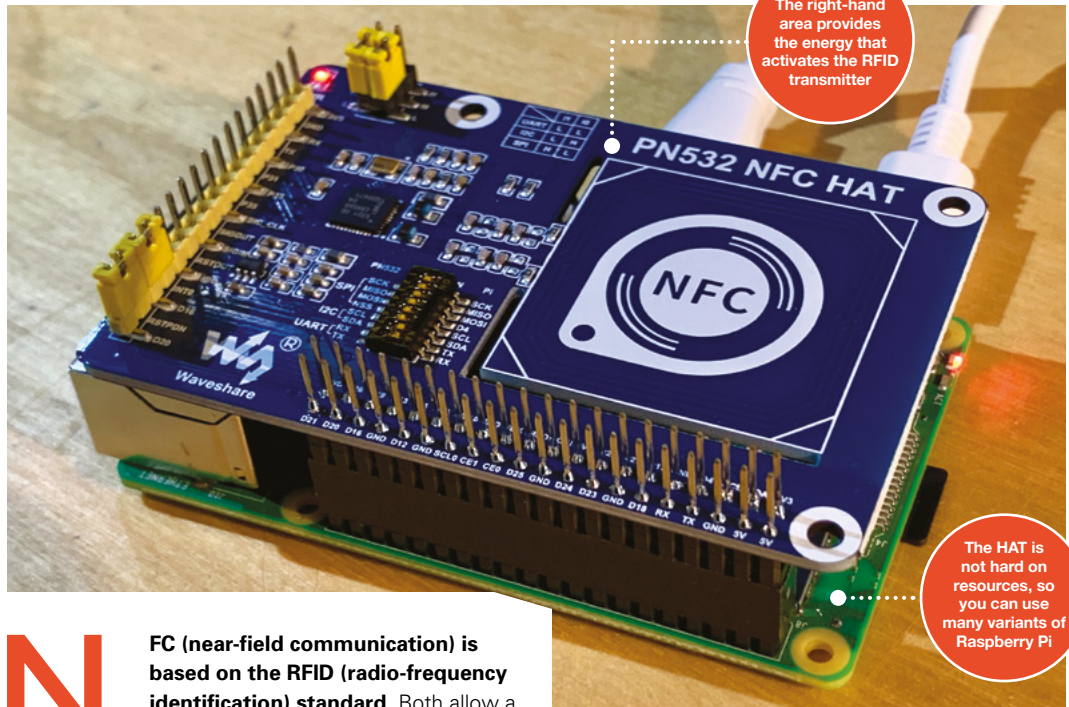

NFC (near-field communication) is based on the RFID (radio-frequency identification) standard. Both allow a device to receive data from a passive token or tag (meaning it doesn't require external power to work). RFID supports a simple ID message that shouts 'I exist', whereas NFC allows for both reading and writing of data. Most people come into contact with these systems every day, whether it's using contactless payment, or a card to unlock a hotel or office door. In this tutorial we'll look at the Waveshare NFC HAT, an add-on for Raspberry Pi computers that allows you to interact with NFC and RFID tokens.

PREPARE YOUR RASPBERRY PI

We start with the usual step of preparing a Raspberry Pi model for the job. Reading RFID tags is not strenuous work for our diminutive friend, so you can use pretty much any variant of the Raspberry Pi range

you like, so long as it has the 40-pin GPIO. We only need Raspberry Pi OS Lite (Buster) for this tutorial; however, you can install any version you wish. Make sure you've configured it how you want, have a network connection, and have updated everything by running `sudo apt -y update && sudo apt -y upgrade` on the command line.

ENABLE THE SERIAL INTERFACE

This NFC HAT is capable of communicating over three different interfaces: I²C, SPI, and UART. We're going with UART as it's the simplest to demonstrate, but you may wish to use the others. Start by running `sudo raspi-config`, going to 'Interfacing options', and selecting 'Serial Interface'. When asked if you want to log into the console, say 'No'. Then,

YOU'LL NEED

- ◆ Raspberry Pi 4 B
- ◆ Waveshare NFC HAT (Supplied with a 1kB NFC token)
- ◆ MIFARE Classic NFC Token

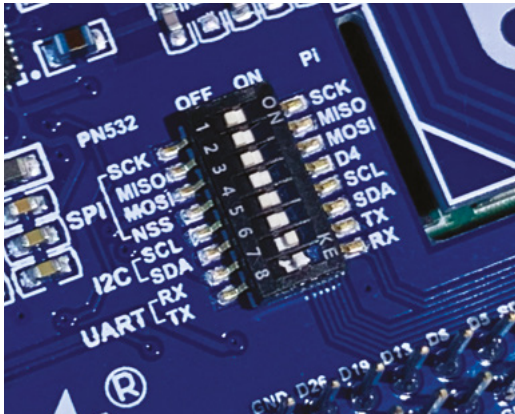

when asked if you want to enable the serial interface, say 'Yes'. You'll need to reboot now. This will allow the HAT to talk to our Raspberry Pi over the serial interface.

CONFIGURE AND INSTALL THE HAT

As mentioned in the previous step, we have a choice of interfaces and swapping between them means changing some physical settings on the NFC HAT itself. Do not do this while the HAT is powered up in any way. Our HAT can be configured for UART/Serial by default but do check on the wiki at hsmag.cc/iHj1XA. The jumpers at I1 and I0 should both be shorting 'L', D16 and D20 should be shorted and on the DIP switch, everything should be off except RX and TX. Check, double-check, attach the HAT to the GPIO, and boot up.

DOWNLOAD THE EXAMPLES

You can download some examples directly from Waveshare. First, we need to install some dependencies. Run the following at the command line:

```
sudo apt install rpi.gpio p7zip-full python3-pip
pip3 install spidev pyserial
```

Now, download the files and unpack them:

```
cd
wget https://www.waveshare.com/w/upload/6/67/Pn532-nfc-hat-code.7z
7z x Pn532-nfc-hat-code.7z
```

Before you try anything out, you need to edit the example file so that we use UART (see the accompanying code listing).

```
cd ~/raspberrypi/python
nano example_get_uid.py
```

Find the three lines that start `pn532 =` and add a `#` to the top one (to comment it out). Now remove the `#` from the line starting `pn532 = PN532_UART`. Save, and exit.

TRY IT OUT!

Finally, we get to the fun part. Start the example code as follows:

```
python3 example_get_uid.py
```

If all is well, the connection to the HAT will be announced. You can now place your RFID token over the area of the HAT marked 'NFC'. Hexadecimal numbers will start scrolling up the screen; your token has been detected! Each RFID token has a unique number, so it can be used to uniquely identify someone. However, this HAT is capable of much more than that as it also supports NFC and can communicate with common standards like MIFARE Classic, which allows for 1kB of storage on the card. Check out `example_dump_mifare.py` in the same directory (but make sure you make the same edits as above to use the serial connection).

GOING FURTHER

You can now read unique identifiers on RFID and NFC tokens. As we just mentioned, if you're using the MIFARE or NTAG2 standards, you can also write data back to the card. The `examples` folder contains some C programs that let you do just that. The ability to read and write small amounts of data onto cards can lead to some fun projects. At the Electromagnetic Field festival in 2018, an entire game was based around finding physical locations and registering your presence with a MIFARE card. Even more is possible with smartphones, where NFC can be used to exchange data in any form. □

QUICK TIP

The Waveshare HAT is based on the PN532 chipset, a ubiquitous industry standard.

Above ■ The Waveshare HAT contains many settings. Make sure to read the instructions

Below ◆ An NFC token. It requires no battery and will work for years

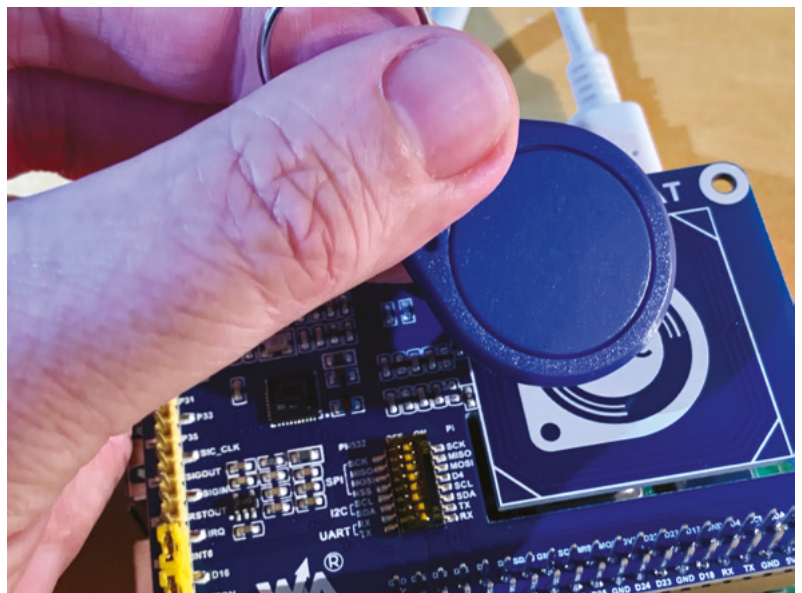

Part 01

Build a Home Assistant with Raspberry Pi



PJ Evans

MAKER

PJ is a writer, software engineer, and tinkerer. He just wants to start his coffee machine on the first morning yawn.

@mrpjevas

Is your house boring? Smarten it up with free home automation tools and Raspberry Pi

Home automation is one of Raspberry Pi's success stories. Our small friend is the perfect orchestrator of many devices around the home. The cost of implementing smart devices such as lights and sensors has fallen significantly over the past few years.

Nevertheless, many have concerns about subscription costs and privacy of the data collected. The good news is that many open-source Raspberry Pi automation systems have matured significantly over the past few years. They now challenge the big players, are free of charge, and put your privacy first. Over the next three issues we're going to set up a smart home from scratch.

01 Your new Home Assistant

To make our home a more fun place to be, we're going to set up a home automation system. This is software that can communicate with multiple devices and make changes to your environment based on a rule set. Sounds a bit complicated, but the 'HA' scene has got a lot more friendly over the past few years. We've chosen the appropriately named 'Home Assistant' (homeassistant.io) because it is a complete operating system package and runs well on Raspberry Pi 3 or above. Best of all, it has incredible support for hundreds of smart devices.

02 Installation and first boot

Home Assistant is available as a full microSD card image – no operating system installation is required in advance. To get the image, go to magpi.cc/homeassistantio. Make sure you pick the right one because different images are available for Raspberry Pi 3 and 4. Once downloaded, burn the images to a microSD card using Raspberry Pi Imager (magpi.cc/imager). We strongly recommend using a wired Ethernet connection for reliability. Whichever you choose, use a wired connection when booting up for the first time. Be patient, Home Assistant will take up to 20 minutes to start up on first boot.

Top Tip

Extra features

Home Assistant integrations can often unlock extra features, such as more colour options in Ikea smart lights.

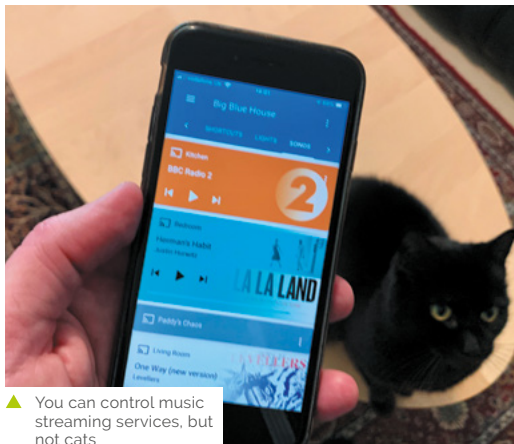

▲ You can control music streaming services, but not cats

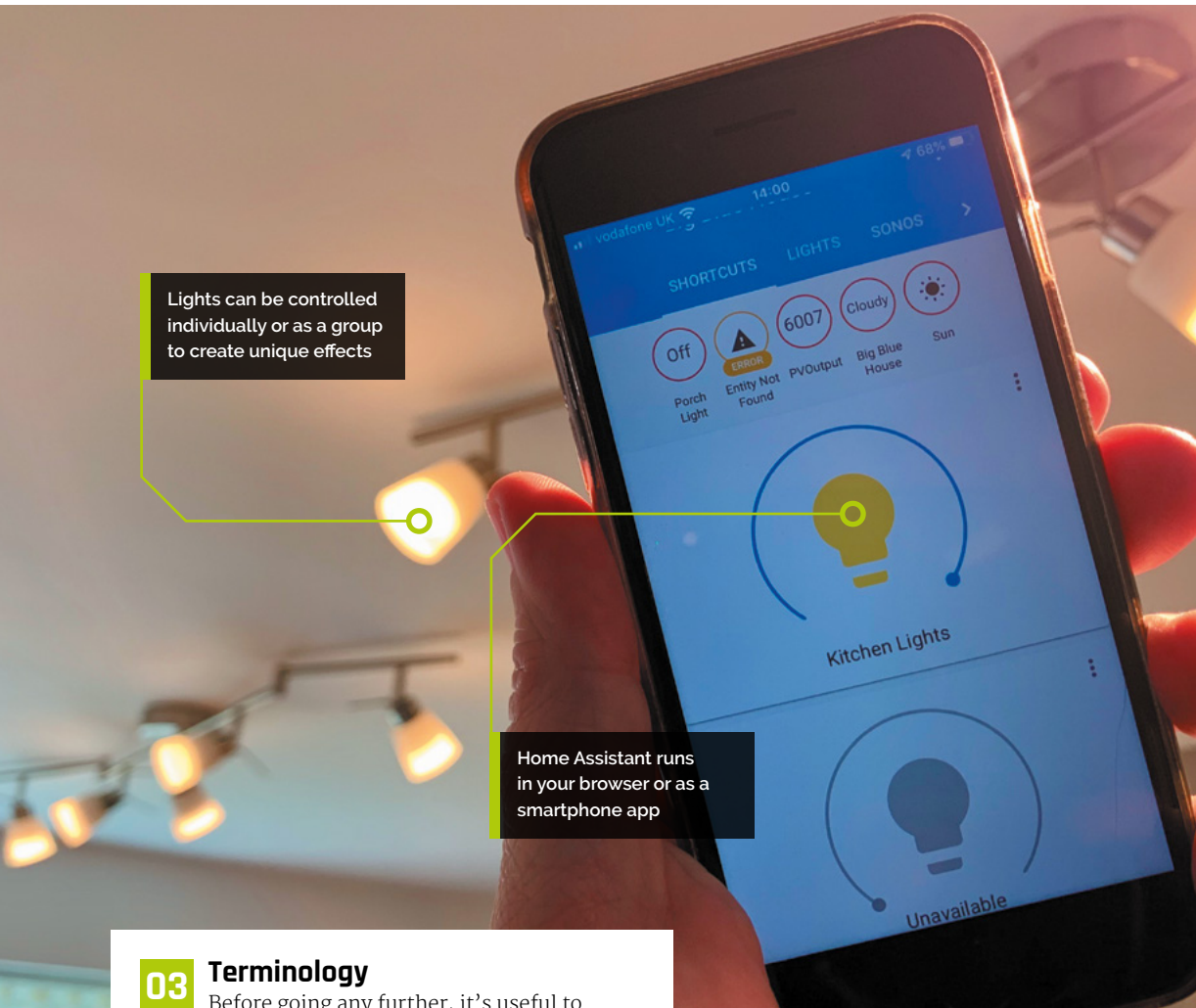

Lights can be controlled individually or as a group to create unique effects

Home Assistant runs in your browser or as a smartphone app

THE MAGPI



This tutorial is from in The MagPi, the official Raspberry Pi magazine. Each issue includes a huge variety of projects, tutorials, tips and tricks to help you get the most out of your Raspberry Pi. Find out more at magpi.cc

03 Terminology

Before going any further, it's useful to understand the terms used in Home Assistant.

Take a look at the 'Home Assistant terms' box in order to better understand Integrations, Devices, Entities, and Areas.

Take some time to become familiar with the terms while Home Assistant is setting up.

Home Assistant terms

These are some of the terms you'll need to know in Home Assistant.

- **Integrations** are software modules that allow Home Assistant to talk to different platforms such as Philips Hue or Nest. There are hundreds available and you can write your own in Python.
- **Devices** are single items that are exposed by integrations, e.g. a printer.
- **Entities** are individual measurements or controls; for example, each different type of sensor on a weather station.
- **Areas** are useful ways of grouping devices and entities, normally referring to a room in your house. There's more, but that's enough to start with.

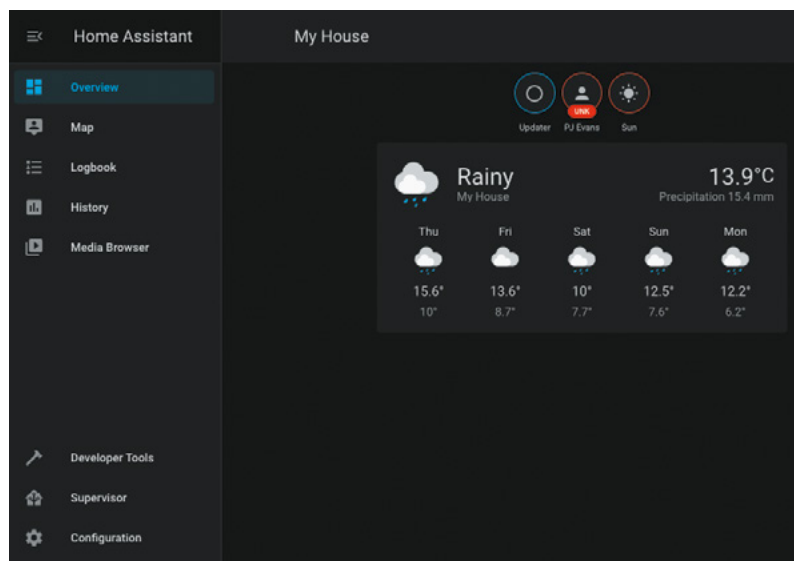

▲ The default overview shows you weather and sunrise times. These can be used to trigger events

TUTORIAL

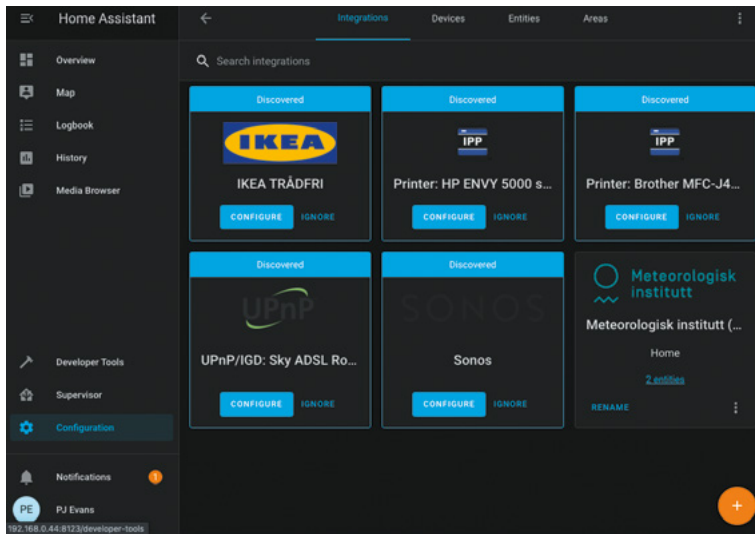

▲ On installation, Home Assistant will attempt to discover smart devices on your network. You may be surprised how many devices are available

04 First connection

After 20 minutes (don't worry, it's a one-time thing), you should be able to see a welcome screen. Open a web browser and visit: <http://homeassistant.local:8123/>.

If not, try using a network utility like Fing for iOS or Android to locate the IP address of the server and try that instead. If you still can't get a connection, try waiting a little longer. Eventually, you should see a 'Preparing Home Assistant' screen. This will shortly change to an account creation screen.

Home Assistant has full support for multiple accounts with different permission levels. The account you create here will have full control over the system.

▼ Using custom panels, we can provide a clear view of our printer's ink supply

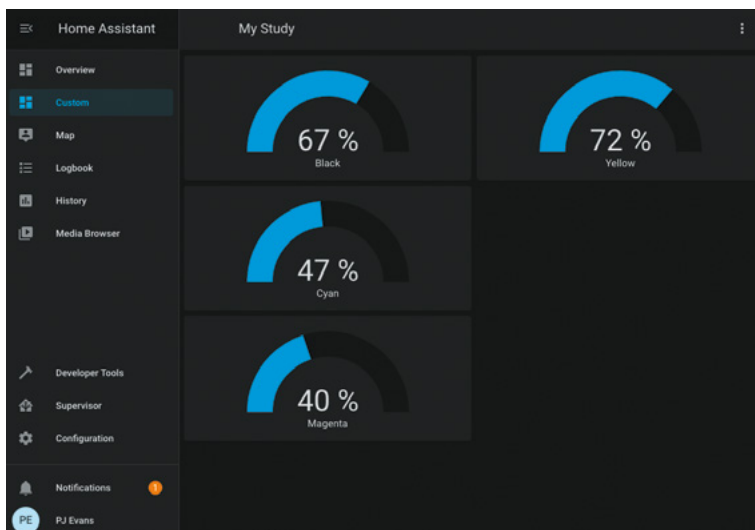

05 Initial settings

Once you've completed the form and created your first account, you will be asked to select your location and give it a name. This information never leaves your network and is used to get information on sunrise and sunset times for where you are. You can also choose your preferred unit of measurement. These details can be changed at any time. You'll now be taken to the Overview dashboard, the heart of the system. A dashboard is a collection of panels that display various bits of information and allow you to control your environment. Your system is already up and running.

06 Your first dashboard

The Overview dashboard has been populated with some initial panels. Largest is the weather panel, based on your location. You will also see 'badges' at the top. Try clicking on the Sun badge for data about today's sunrise and sunset. There will also be a person badge which will probably say UNK for 'unknown'. We'll come to that later. For now, explore the left-hand menu. You can see a map (this will get more useful), a log of all events, and several configuration options. You'll also see Notifications – the chances are, you'll have one waiting. If you do, Home Assistant has discovered things on your network that it can talk to.

“ Printers, routers, and media systems will all happily introduce themselves to Home Assistant ”

07 Your first integration

Did you click that notification in Step 5? If so, you've probably been informed that Home Assistant has already found some devices on your network. It can be surprising how chatty some things can be. Printers, routers, and media systems such as Sonos will all happily introduce themselves to Home Assistant. To actually start using the integrations, click on Configuration then Integrations. Now click Configure on your choice of integration. Some additional information may be required, but often auto-discovered integrations work out-of-the-box. If a particular integration is not of interest to you, click Ignore to hide it.

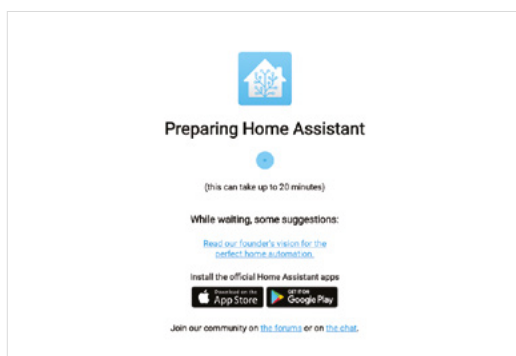

08 Automatic dashboards

Once you've enabled and configured some integrations, go back and have a look at the Overview dashboard. Home Assistant will have automatically added an appropriate panel to show data or add controls. If you have a Philips Hue or Ikea Trådfri gateway, your lights will have been discovered and added to the panel. This feature makes getting started with Home Assistant a breeze. If you're happy with this, you can let Home Assistant update and configure your panel as you add new integrations and devices. However, if you want full control, you can disable this feature and create your own panels.

09 Your own dashboard

When we installed our Home Assistant, it found our networked printer and created a panel that showed the ink levels for each cartridge. It's a bit dull, so let's make a better one. By clicking on the three dots at the top-right of the screen, we can Configure the UI. You'll see a warning that automatic configuration will be disabled. You can now edit, move, delete, and add new panels. You can also add tabs across the top and you can have as many dashboards as you like. We created a new tab for our printer.

10 Adding panels

We now have a nice, clean area to work with. Click the + icon at the bottom-right to add new panels. You will see all the default panels available, covering many different use cases. These include switches, gauges, playback control for media centres, and many more. You can even design your own. We clicked the 'gauge' panel as that seemed best for printer ink. Home Assistant is helpful enough to work out what entities are best for the type of panel and you can control certain aspects such as warning thresholds. We added a gauge for each of our printer ink cartridges.

11 Adding new integrations

We strongly recommend spending some time looking at the available integrations. Click on Configuration, Integrations, then click the + icon. You will be presented with a bewildering list of possibilities. We found an integration for pi-hole, the ad-blocking service. After entering the address of our Raspberry Pi 4 running the service, we had a panel full of stats to look at. Some integrations increase the capability of Home Assistant to talk to other devices. For example, the MQTT (Message Queuing Telemetry Transport) integration allows Home Assistant to subscribe to MQTT topics and trigger events. If you're handy with Python, you can create your own custom integrations too.

◀ Home Assistant can take up to 20 minutes to boot first time, so go and make a cuppa

12 Going mobile

If you've set up all your lights to work with Home Assistant, it's going to be a bit pointless if you have to run to a computer every time you need to flick a virtual switch. An essential part of any Home Assistant setup is the smartphone app (iOS or Android). This not only allows you quick access to your dashboards, but also adds you as an entity. The app communicates with Home Assistant and provides location and activity information. All your health stats tracked by your phone can be added and your location reported. All this data stays in your network and you can switch it off any time, but there are great possibilities that we'll look at next month. 📱

Top Tip

Back it up!

Home Assistant setups can get complicated. Luckily, you can download a system backup in one click. Make sure you do!

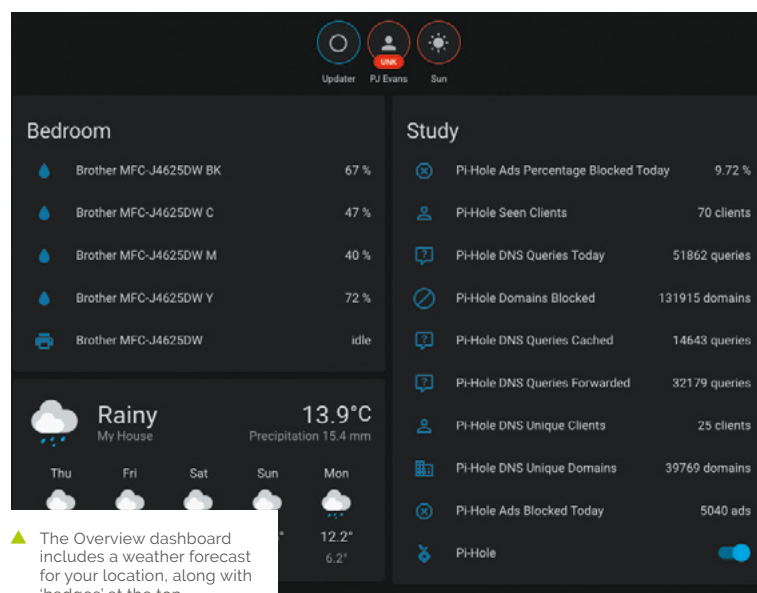

▲ The Overview dashboard includes a weather forecast for your location, along with 'badges' at the top



Etching around

Build a rotary adapter for your laser cutter and make your mark on bottles and jars



Dr. Andrew Lewis

Dr. Andrew Lewis is a specialist fabricator and maker, and is the owner of the Andrew Lewis Workshop.

K 40 laser cutters are excellent tools for engraving on flat surfaces, but they can't engrave on cylindrical objects without a special adapter.

In this article, you'll learn how to make a rotary laser adapter for your laser cutter, how to install it, and how to set up your software to etch patterns at the correct scale on different-sized objects.

With a rotary adapter installed on your machine, you can engrave on glasses and cups, cut plastic, and cardboard tubes. The adapter works by taking the control signals intended for the Y-axis motor, and using them to revolve metal tubes instead. Any cylindrical object placed on the metal tubes will also rotate, and if you position the laser over the object, you can engrave onto its surface as it revolves.

To build your rotary adapter, download and print the 3D files for the pulleys, shaft ends, and chassis pieces. Begin by fitting one pulley onto the end of

each copper tube, and then insert the shaft ends into the ends of the tubes. Note that one of the shaft ends has a D-shaped hole for the motor, and should be fitted in the same end of the tube as the pulley. These parts are designed to push-fit into the tube, but can be held in place with a little superglue if necessary.

Next, attach the motor to the chassis so that the feet of the chassis are facing away from the body of the motor. Attach the copper tubes to the chassis by push-fitting the shaft end with the D-shaped hole onto the motor shaft, and fix the other three shaft ends in place using M5 machine screws. The screws should be able to move in the chassis with minimal resistance, but should screw into the shaft ends tightly enough to prevent wobbling. Finally, measure and cut a piece of 3 mm plywood to fit on top of the chassis feet. The plywood should measure about 85 mm × 290 mm, but it's best to measure against the actual assembled chassis to get the best fit.

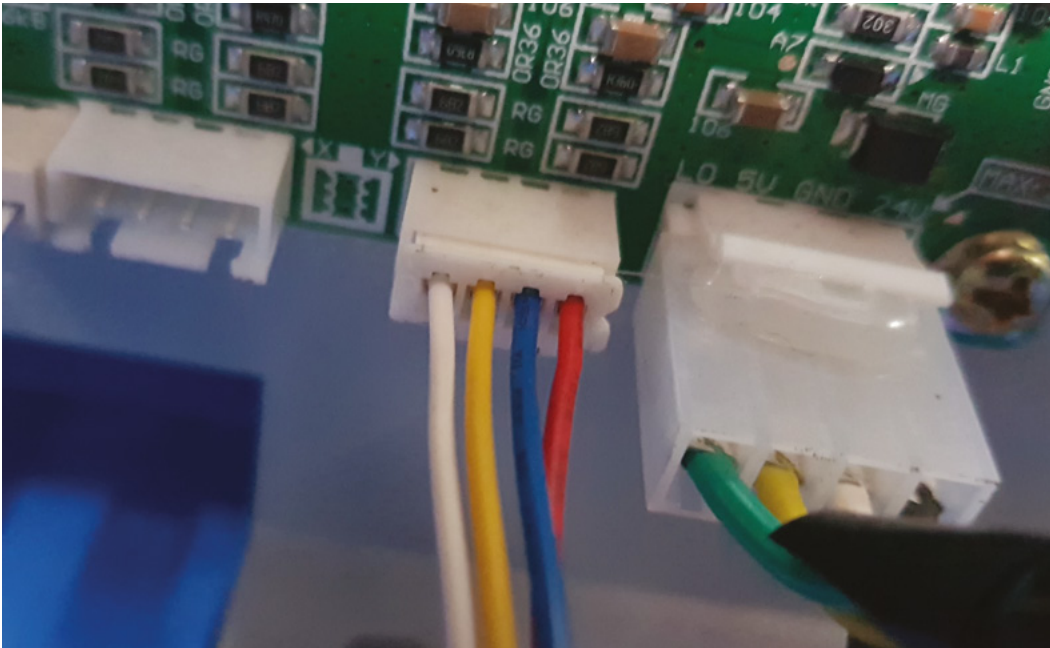

Left ♦ On most K40 lasers, the Y-axis motor connects to the control board using a four-pin plug. The X-axis and optical endstops connect using a flexible ribbon cable. If you ever find that your laser isn't homing properly, it's worth checking the condition and seating of the X-axis cable as it's prone to working loose. Some users replace the flat ribbon with flexible silicone cabling to improve reliability

Below ☒ One way of making sure that you get the wires connected in the right order is to fit the plug and socket together before soldering the wires. Doing this makes it very easy to see if you've transposed any of the connections

UNMAKE YOUR BED

The adapter needs a way to connect to the laser cutter, and the easiest way of doing this is to fit a socket on the inside of the machine where the adapter can plug in. Start by finding the motor that controls the Y-axis. On most machines, this is at the bottom right of the cutting chamber, and may be hidden by a metal screen. Follow the wires from this motor back to the control board, and note where they attach. Take the aviation socket, and find a convenient position to mount it. The bulkhead around the bottom right of the build chamber is usually best, making sure that any connected plugs and wires will be well clear of the laser gantry as it moves around.

Drill the metal bulkhead and fit the socket into place so that the soldered connections will be closest to the power supply side of the bulkhead, and the socket will be accessible from the cutting chamber. Cut the wires to the Y-axis motor, and fit the plug and socket in-line, so that the plug is on the motor and the socket is on the wires connected to the control board. Double-check that the wire colours in the plug and

With a rotary adapter installed on your machine, you can engrave on glasses and cups, cut plastic...

socket match, and fire up the machine to make sure everything is still working properly before you move on to the next step.

Use a multimeter to figure out the wiring order of the stepper motor on the Y-axis, and on the rotary adapter. Each motor should have four wires and two coils, so a simple check for continuity should be enough to figure out which wires are connected to which coil. Wire an aviation plug onto the rotary adapter motor so that the connections match →

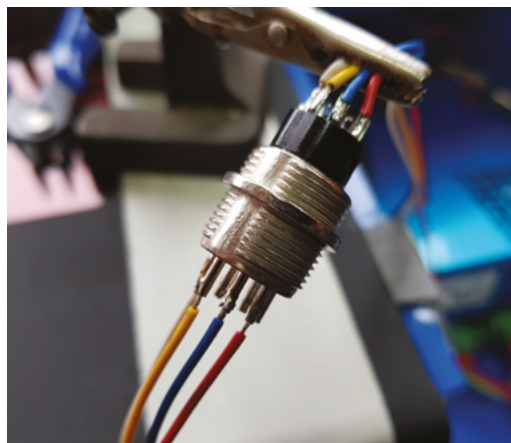

YOU'LL NEED

- ♦ 160 mm CT2 belt
- ♦ NEMA 17 stepper motor
- ♦ 2 x 15 mm diameter copper pipes, 28 cm long
- ♦ 2 x aviation plugs
- ♦ An aviation socket
- ♦ Set of 3D-printed parts
- ♦ Piece of 3 mm plywood (or similar) for base
- ♦ 3 x M5 20 mm machine screws
- ♦ 4 x M8 40 mm bolts (optional)
- ♦ A4 sheet of 3 mm plywood

TAKE CARE

Drilling holes inside your laser cutter can be a risky business, and the small pieces of metal swarf created when drilling can cause mayhem inside your machine. Minimise the chance of any problems by covering sensitive parts of the machine in plastic or paper before you start drilling, place a magnet near to the hole you're cutting to catch stray bits of metal, and vacuum-clean the case immediately after you've drilled the hole.

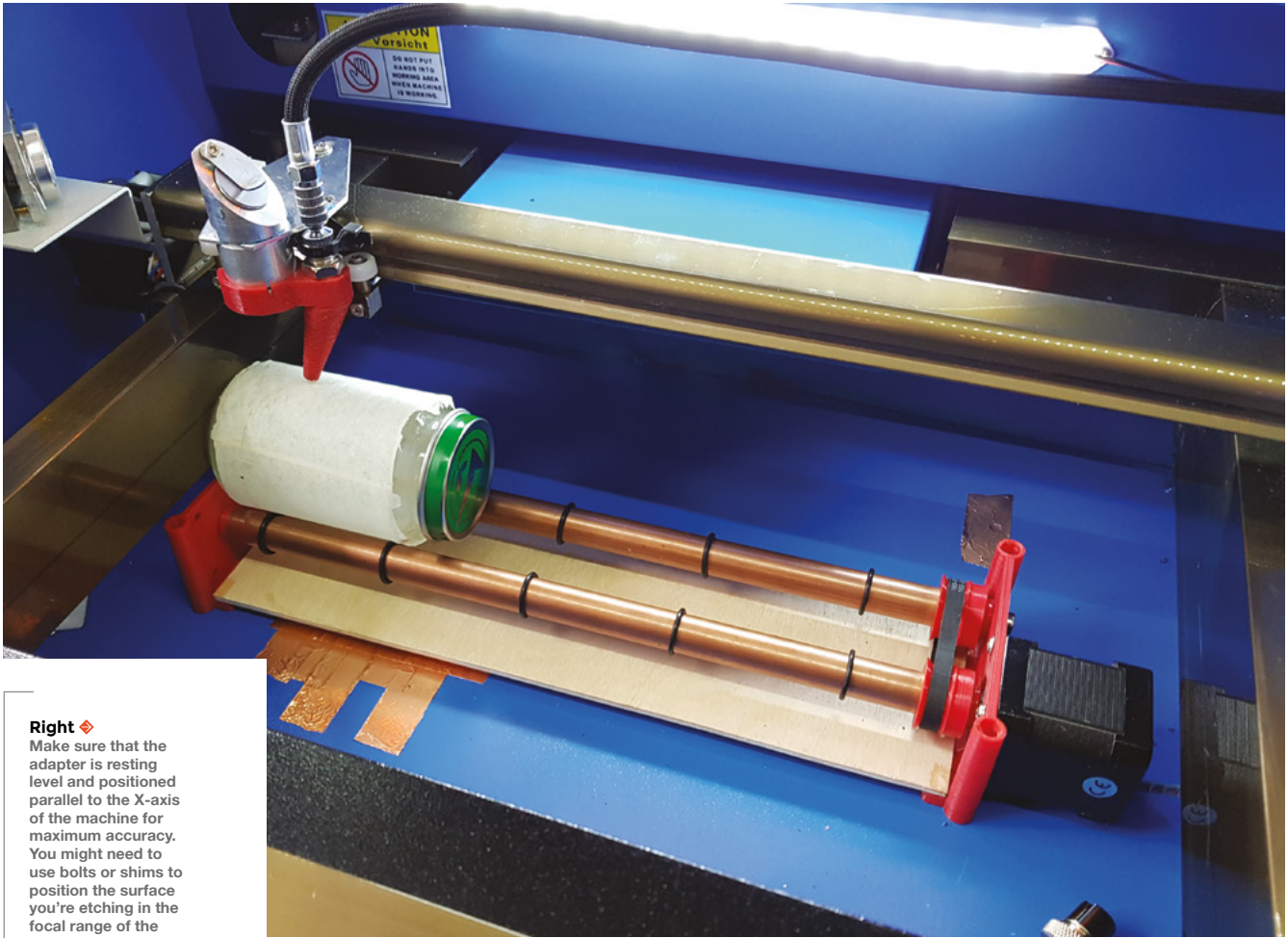

Right ♦

Make sure that the adapter is resting level and positioned parallel to the X-axis of the machine for maximum accuracy. You might need to use bolts or shims to position the surface you're etching in the focal range of the laser. If you need to etch larger items, it is possible (but not advisable) to cut a hole in the bottom of the laser cutter and mount the rotary adapter underneath. If you do cut a hole in the bottom of the machine, you should take care to make sure that the chamber is completely shielded with metal to prevent any accidental exposure to the laser beam

Right ♦

You can protect the object you're working on while you calibrate by wrapping it in a layer of masking tape and setting your laser to very low power. The laser should just mark the tape without cutting through and marking the object underneath. The thickness of the masking tape is unlikely to make a significant difference to the calibration process



the Y-axis motor. With the machine powered off, disconnect the Y-axis motor from the socket, and plug in the rotary adapter.

PROBE YOUR MOTORS

When you next turn on the laser cutter, the rotary adapter will spin continuously. This is normal, and is caused by the control board trying to move the lens carriage to the home position. The Y-axis motor is disconnected, so the carriage will not reach the Y-axis endstop until you push it there with your hand. Once you have manually homed the axis, the adapter

MAKING THE BED

You will need to remove the bed from the laser cutter to make space for the rotary adapter. Different versions of the K40 laser have different bed-fixing methods. Some beds mount to the sides of the carriage, and others mount to the bottom of the machine. Removing the bed is generally a simple case of removing a few bolts, and then blocking up any holes in the laser chassis with metal tape.

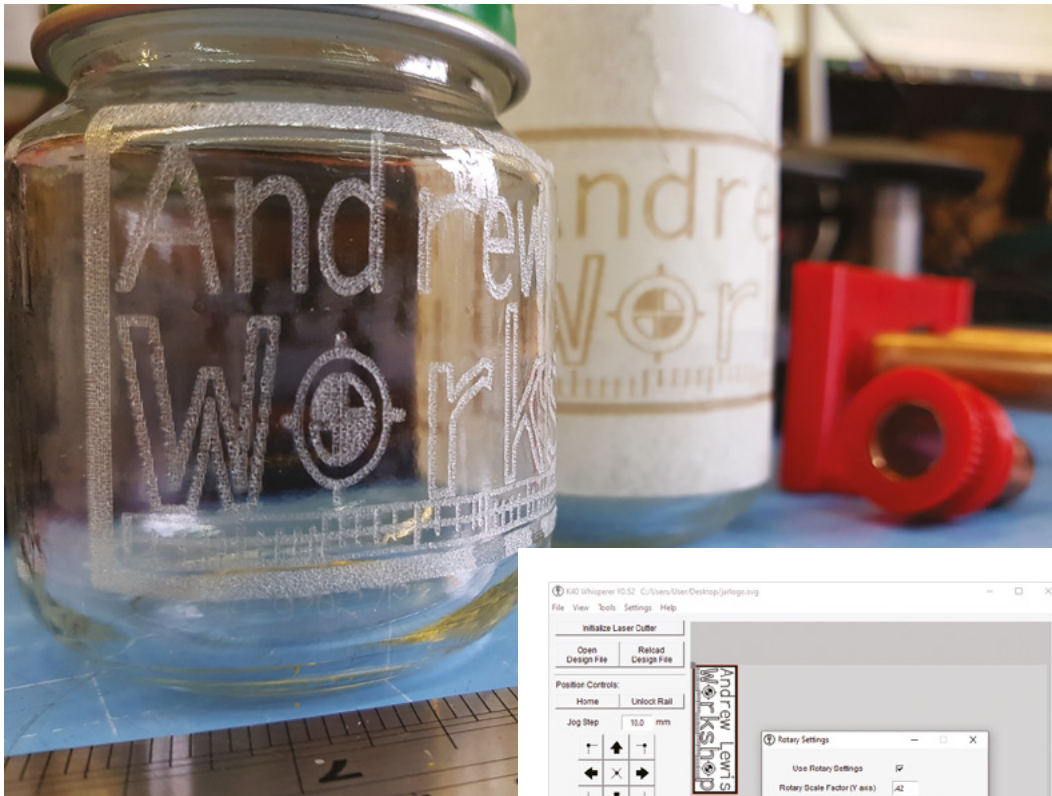

Left ◆
 You can etch anything cylindrical, but we're particularly keen on the look of etched glass (such as this jam jar)

Left ▣
 The Rotary Settings dialog box in K40 Whisperer lets you activate or deactivate Y-axis scaling and rapid speed throttling to make using a rotary adapter easier. The Y-axis scaling compensates for the effect of object diameter on surface travel, and the rapid speed throttling allows you to reduce the maximum travel speed for the motor. This can be useful if you find that your objects slip or fall off the rotary adapter when the motor turns at high speed

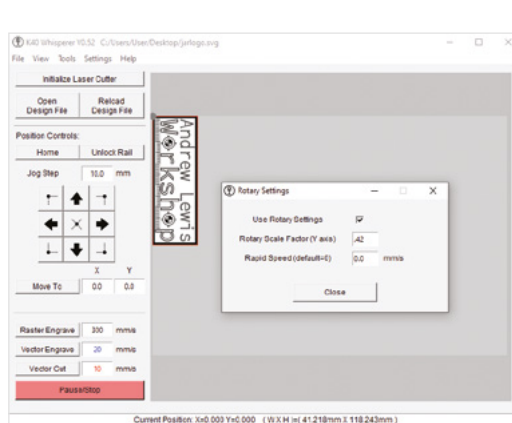

will stop spinning, and you can reposition the laser carriage so that it is over the top of the rotary adapter. Congratulations, you've built and connected up your rotary adapter, and now it's time to calibrate it and make your first test etchings. Create a document in Inkscape containing a 100 mm square with a transparent fill and a black stroke. Resize the document to match the size of the square, and save it as an SVG. This is your calibration image, and you'll use it to set up the software to control your rotary adapter. Start up the K40 Whisperer software, load the document that you just created, and etch it onto your target object.

the expected size by the actual size. So, if your square should be 100 mm, but the etched shape is 160 mm, then you would do $100/160 = 0.625$. In K40 Whisperer, press the **F4** key to bring up the rotary settings box. Tick the box to confirm that you want to use rotary settings, and enter the scaling factor you calculated into the box labelled rotary scale factor. Repeat your calibration etch and remeasure the size of the box. This time, the box should measure 100 mm square, and you're ready to start etching. ▣

“ You'll probably notice that your etched square is actually a rectangle. **This is normal** **”**

You'll probably notice that your etched square is actually a rectangle. This is normal, and happens because the ratio between the rotation of the motor and the distance travelled at the surface of the object will vary depending on the size of the object. To correct this, you need to measure the actual size of the square and calculate the scaling factor by dividing

SLIPPERY WHEN WET

It's common to use liquid soap on glass sheets to act as a coolant and improve the quality of the etch. If you do this with the rotary adapter, you'll find that the glass starts to slip because the rotary drive relies on friction. Using a thin layer of thick soap and putting a couple of elastic bands around the object to act as rubber tyres should stop the soap from touching the rotary adapter and causing slippage. Don't forget that the elastic band will affect the diameter of the object, and therefore the calibration settings for the etch.

QUICK TIP
 Never plug or unplug motors while the laser cutter is switched on. You can permanently damage the control board by doing so. Always power off the machine before touching the plugs.

FreeCAD for beginners

In this first part of a miniseries, we will get started with FreeCAD and use some of the tools to design a set of small wheels to be 3D-printed



Jo Hinchliffe

@concreted0g

Jo Hinchliffe is a constant tinkerer and is passionate about all things DIY space. He loves designing and scratch-building both model and high-power rockets, and releases the designs and components as open-source. He also has a shed full of lathes and milling machines and CNC kit!

First, go to freecadweb.org and download a copy of FreeCAD for your operating system. When you open FreeCAD, it defaults to a 'start' workbench which has limited tools but shows recent files and example files in the viewer window on the right-hand side (Figure 1). FreeCAD uses 'workbenches' which you can switch between. If you click the drop-down menu where it says 'start', you will see all the installed workbenches (Figure 2). The idea of workbenches is simple: imagine a large workshop with multiple benches, and each bench has a different collection of tools focused around a theme. FreeCAD has workbenches with tools to make parts, create architecture, assemble collections of parts into assemblies, create toolpaths for CNC, create technical drawings, and much more. The beauty of these workbenches is that FreeCAD automatically carries all your work between them when you switch benches. As you progress in FreeCAD, you will use more workbenches, and you might even install extra workbenches you discover in the FreeCAD community.

FIRST DESIGN

To begin, click 'create new' and the document viewer window will create an empty project in a new tab. Next, we are going to switch from the 'start' workbench to the 'part' workbench using the workbench drop-down menu. The part workbench is a good place to start to get oriented and to explore one of the simplest ways to make parts. Before we go too far, though, let's explore how we navigate, zooming and moving objects, in the preview window. You should be able to see a collection of tool icons that contain yellow shapes of a cube, cylinder, sphere etc. Left-click on the cylinder icon and you should see a cylinder appear in the viewer window. It probably will have defaulted to a top view of the cylinder, so you may only see a circle as you are looking straight down from above. There are numerous ways to switch the viewpoint in FreeCAD. First, you can use the cube in the upper right-hand side of the preview window to move to view different faces. You can also use the blue 'view' icons that appear as a cube with a single face marked as solid in the toolbars. If you hover over the view icons, you get a description of the view type they relate to and also a number. This indicates that you can also swap views by just using the number buttons **1**, **2**, **3**, and **4** on your keyboard.

NAVIGATION

However, a common way to navigate and select items and parts in FreeCAD is in the viewer window itself, and there are numerous different navigational styles available for you to choose from. If you hover over the viewer window and right-click, you can scroll to 'navigational styles' and a drop-down list appears (Figure 3). Some of the navigational styles are based on other CAD environments, so if you are used to using, for example, Blender, then you might prefer that style. We use the 'gesture' style option that

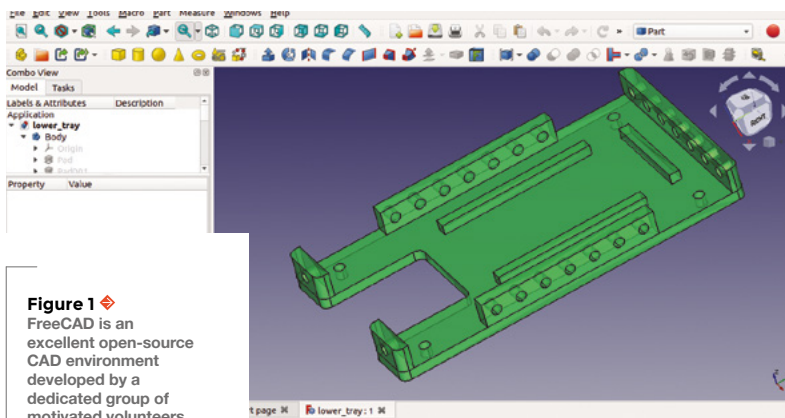

Figure 1 FreeCAD is an excellent open-source CAD environment developed by a dedicated group of motivated volunteers

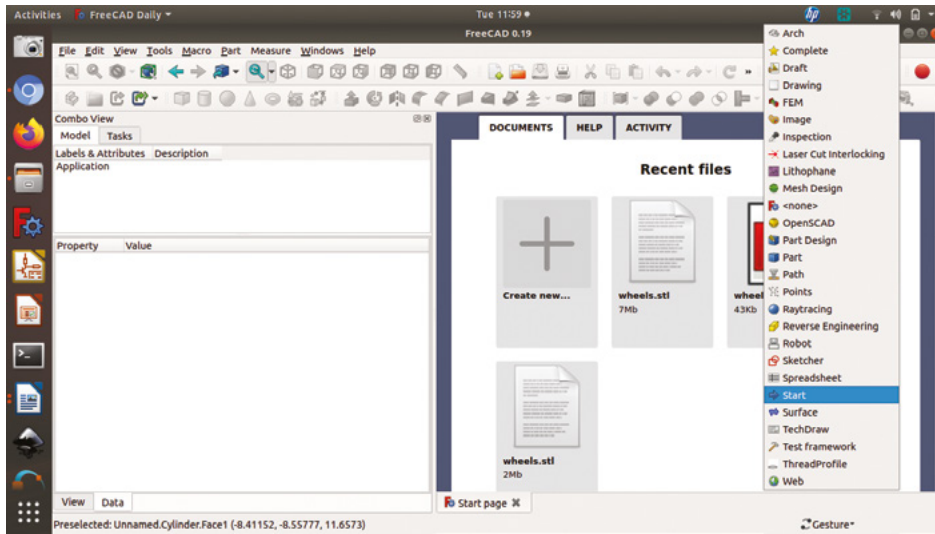

Figure 2 The workbench selection drop-down – each workbench has a collated set of tools for specific types of work

Figure 3 Spend some time trying different navigation styles to find one that suits you

gives left-click for rotation in the document window, right-click for moving, and the centre button/wheel is for zooming. Of course, you need an object like the cylinder we created to allow you to judge which navigational style suits you best.

SET UP YOUR WORKBENCH

The part workbench is used largely to create parts by combining solid primitive objects like the cylinder we created. It's definitely a good place to start, but you may find as you learn more/other ways to create

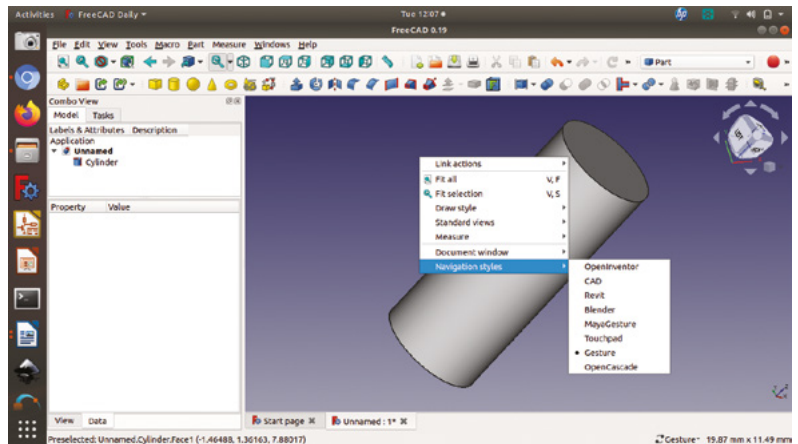

QUICK TIP
Hover your mouse over any tool icon in FreeCAD for a couple of seconds to get a text description of what the tool does.

// You need an object like the cylinder we created to allow you to judge which navigational style suits you best //

parts on different workbenches, you use this workbench less. Returning to the cylinder we created, we can see that on the left-hand side of the screen there is a file-tree-type view, and under the heading 'unnamed project', we can now see that 'cylinder' is listed, (Figure 4, overleaf). We can single-

left-click on this cylinder label in the file view to select the object, or we can click on the various faces and edges of the cylinder in the document window to select them. Clicking on the label in the drop-down menu, you should see that underneath this a new dialog box appears with details about the dimensions and position of the cylinder. Initially, the first things you can change here are the radius and the height of the cylinder. Let's imagine we are making a simple wheel for a toy car, and make the wheel radius 12 mm. Next, let's set the height of the cylinder to 15 mm.

WHOLE HOLES

Click the cylinder tool once again and you'll see another cylinder appear in the file tree view. You may not see the cylinder appear in the document viewer window, however, as it's smaller than our other cylinder and is currently positioned inside it. If we left-click the new cylinder in the file tree view, it should appear highlighted in the document viewer window. Change the radius of the new cylinder to →

YOU'LL NEED
A laptop or desktop computer

FREECAD VERSION

FreeCAD has quite long development cycles, and there is quite a lot of difference between the current stable version 0.18.4 and the development 'daily' versions 0.19. For this series, we are going to use 0.19, as most FreeCAD contributors and developers recommend using this. We are using the app image version on Ubuntu 20.04; however, this should be the same for the 0.19 version on Windows or Mac.

TUTORIAL

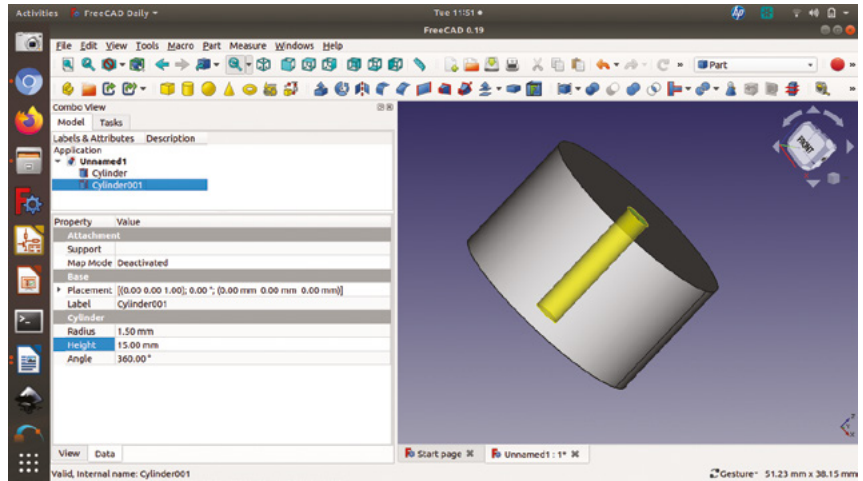
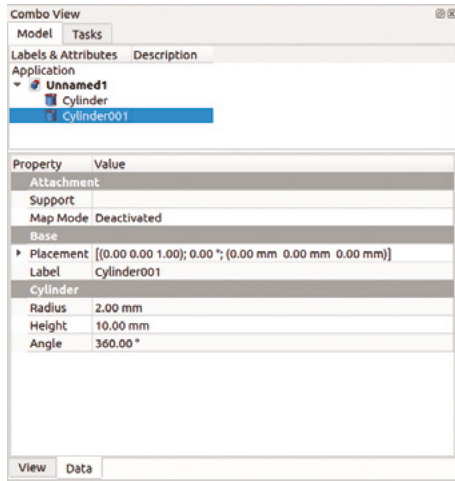

1.5mm and adjust the height to match our first cylinder, which was 15mm. If we click anywhere off the image of the cylinders in the viewer window, we should now be able to see the ends of the cylinder we created in the top and bottom of the original cylinder (Figure 5).

then hold either the **SHIFT** or the **CTRL** key down whilst you select the smaller cylinder. Once they are both selected, click the 'make a cut of two shapes' tool icon and a hole should appear through your first cylinder. If for any reason both cylinders disappear, it probably means you have selected them in the wrong order and have cut the larger cylinder out of the smaller one, which leaves no object behind! Press **CTRL** and **Z** to undo and try again. The shortcuts may be different on your OS. You can see, and change them in the Tools > Customize menu.

Figure 4 ♦ The combo view panel on the left-hand side includes a file tree window for selecting objects and parts. When an object is highlighted, its dialog box appears below

Figure 5 ■ It can be hard to see objects when one is positioned inside another. Hovering over object names in the file tree will make them appear highlighted in the viewer window

Figure 6 ♦ When moving objects, or rotating them, we can set the increments to allow us to quickly position objects accurately

SLICING AND DICING

Similar to most drawing and CAD packages, we can combine objects in multiple ways to create new objects. You should be able to see a selection of tool

Similar to most drawing and CAD packages, we can combine objects in multiple ways to create new objects

icons, some of which feature blue circles overlapping in different ways. Hovering over these icons, you should find one described 'make a cut of two shapes'. We are going to use this tool to cut the 1.5mm radius cylinder we just made out of our larger one. Select the larger cylinder first in the file tree and

You should now see that in the file tree your cut object has been renamed to 'cut'. If you click the small arrow to the left of 'cut', you should see a drop-down which contains both your original cylinders but greyed out. These objects, despite being components of a completed cut, can still be altered. For example, if we wanted to change the radius of our hole to 2mm from its current 1.5mm, we can do this without redoing the cut operation. Select the file tree name for the smaller cylinder, then press the **SPACE** bar. This should make the cylinder that made our hole visible in the viewer window. We can then use the dialog box to change the radius of the cylinder and then press the **SPACE** bar again to turn off the visibility of the object. This should reperform our cut with the new-sized cylinder. We can also change the position of the hole if needed by moving the object.

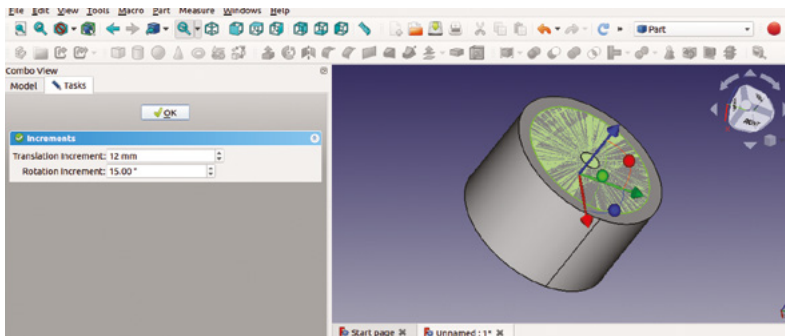

WHEELY GOOD

Our wheel design looks a little unrefined, so let's add some features to make it look a little cooler. Let's create another cylinder and change the radius of this cylinder to 10mm, and set its height to 3mm. We are going to perform another cut with this object, but we want to move it to the top of the wheel design. To do this, double-click on the new cylinder object in the file tree. You should now see a dialog box called 'increments', and in the viewer window, the cylinder will be highlighted with some red, green, and blue

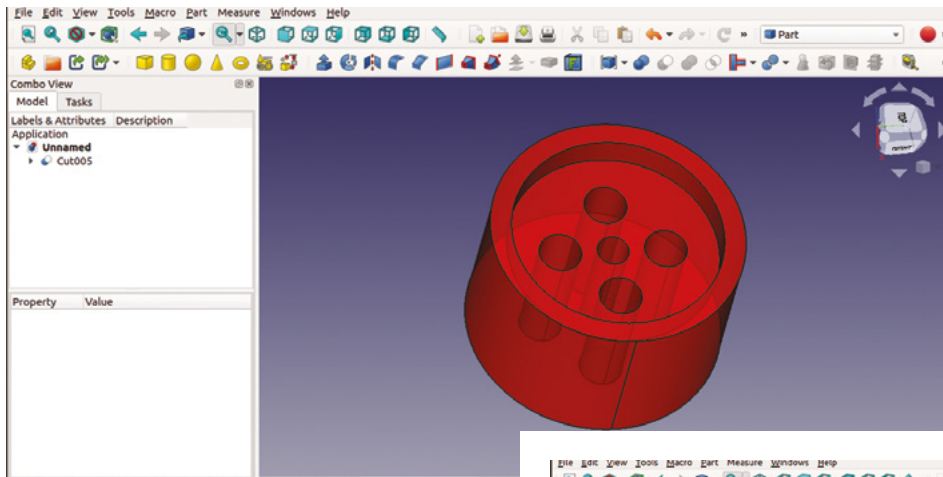

Figure 7 ♦
Our wheel design with all the cut operations performed on it and transparency set to 30 percent to allow us to see the internal geometry

arrows attached. These arrows correspond to the x, y, and z axes, and left-clicking and dragging on either the red, green, or blue arrow points will move the item in that direction. It will move the object in multiples of the amount set in the 'translational increment' box, (**Figure 6**). This usually defaults to one millimetre, but we can set it to any step size we prefer. For example, in our case, if we set the translational increment to 12 mm, we can then drag the blue arrow by one step, bringing our 3 mm-high cylinder flush with the top of our design. Whilst we don't need it for our wheel, it's worth having a play with clicking and dragging the red, green, and blue spheres on the arced lines with the translation arrows. Clicking and dragging these rotates the object around the axis the colour represents. Again, you can set the rotational increment dialog to whatever number of degrees you like.

Next, perform a cut to remove the new cylinder from the design. We then continued to make our wheel look a little fancier by creating four more cylinders. We moved the four cylinders equally outwards by 5 mm from the centre of our wheel using the moving techniques we learnt earlier. You should end up with a simple wheel that looks like **Figure 7**.

FINISHING TOUCHES

Our wheel is looking wheel-like, but the part workbench has some simple tools we can use to embellish it a little. You may have noticed in the viewer window that you can highlight/select either the faces or the edges of objects. Often you can also select corner points of objects, but as everything is circular in our wheel design, that doesn't apply here. The part workbench has two nice tools for adding either fillets or chamfers to edges of objects. They appear as two tool icons: the fillet tool as a curved area between two flat surfaces, and the chamfer tool as an angled flat surface. In the viewer window,

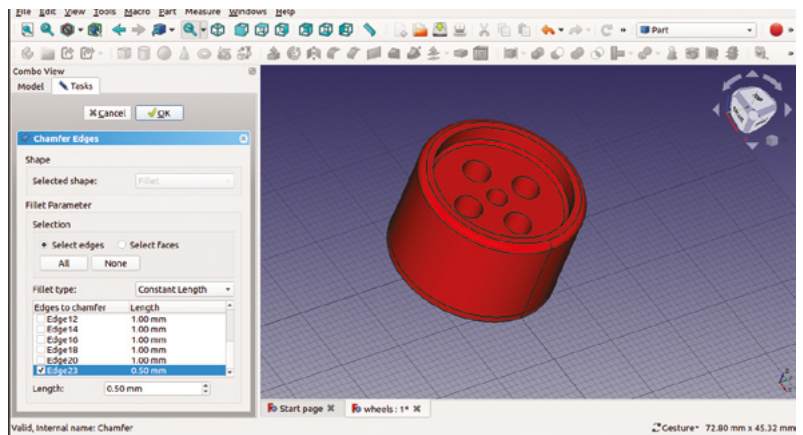

left-click to select the outside edge of the top of our wheel, and then click the fillet tool. In the dialog box, we can see a list of edges, including our selected edge. This is useful if you want to apply multiple fillets to multiple edges in one operation. You can also adjust the radius of the fillet in the dialog. We'll leave ours at 1 mm and click OK to apply the fillet. Both the fillet and the chamfer tools can be used on either external or internal edges. As an example, let's select the edge inside at the bottom of the large →

Figure 8 ♦
Adding chamfers and fillets to internal and external edges of parts is made simple in FreeCAD

Figure 9 ♦
Using the drop-down 'part' menu to create simple copies of our wheel

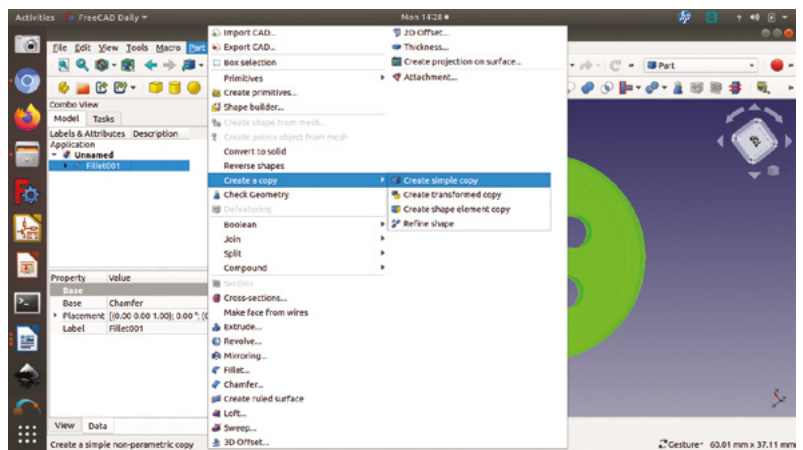

TUTORIAL

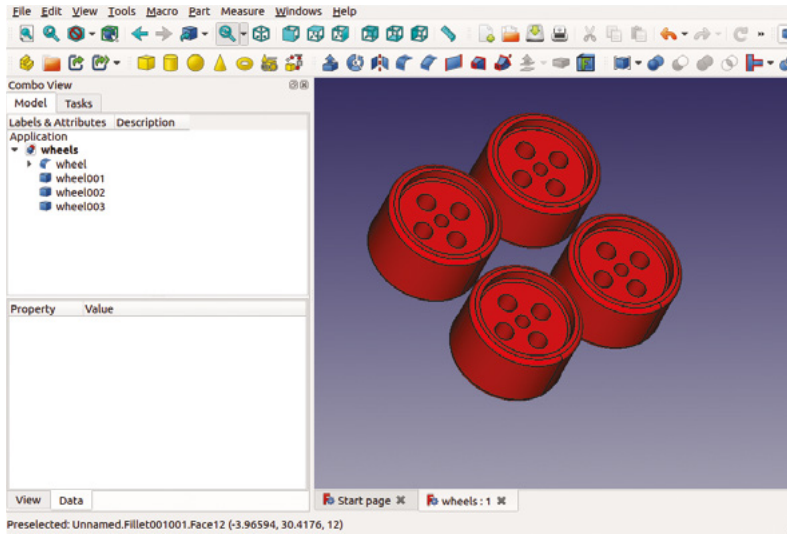

cut-out at the top of our wheel. Click the chamfer tool this time, and set the chamfer length to 0.5mm and OK it (Figure 8, overleaf). You should see that a nice internal chamfer has been created. Finally, we added a matching fillet to the bottom outside edge of our wheel.

RENAME

Now we have our basic wheel design (it's called 'fillet' in the file hierarchy). Whilst we can click it to select the entire wheel, if we double-click it, this reopens the dialog for the fillet operation. This means that this part can be tricky to move. A common way to deal with this, which is also useful for us as we

Figure 10 ♦
Our finished set of wheels, ready for export

Figure 11 ♦
Our wheel design, exported and 3D-printed

want to have four of our wheels, is to create simple copies of a part.

First, to help keep things orderly, let's right-click on 'fillet', select 'rename', and call it 'wheel'. Renaming this doesn't change the fact that if we double-click it, it won't open up the fillet dialog, but will help us track when we make multiple items.

CREATE COPIES

To create our copies, single-left-click 'wheel' in the file tree view to select our wheel and then go to the 'part' drop-down menu; select 'create a copy', then 'create a simple copy' (Figure 9, overleaf). Clicking this option will create a new 'wheel001'. If we double-click on wheel001, we can see that it can now be moved as a separate item. As we made a 'simple copy', our new wheel doesn't contain the hierarchy of operations and objects our original has and also is not dynamically linked to the original object. This means that if we make further changes to our original 'wheel', these aren't pushed through to the simple copies. However, of course, you can delete the copies, make a change to the design, and recopy if needed.

THE NEXT STEP

Let's make copies and lay them out as a set of four (Figure 10). We're going to 3D-print these wheels, and we could just export one instance of the wheel and then duplicate it in our slicer software – but, again, it's just as easy to do this in FreeCAD. Having made our four copies of the wheel, let's save our work and then, click 'file – export'. We can export a mesh file of the wheels ready for slicing for 3D printing. If we don't specify the type of mesh file by adding a file suffix, it will default to an STL file. Having exported our STL file, we could open it in our favoured slicer and 3D-print them (Figure 11). However, FreeCAD isn't only for 3D printing, and in future tutorials, we'll look more widely at what FreeCAD can do. □

TRANSPARENCY

Selecting items in the file tree makes them become highlighted in the document viewer window and, whilst this is useful sometimes, it's easier to set some component items to be different colours and adjust their transparency. This can help us see the internal geometry of parts, and can allow us to check internal positions. To do this, highlight a part in the file tree view and right-click. Scroll to 'appearance'. In the menu that appears, you will see that you can set the material type and also the shape and line colour, and also set the transparency.

Create Graphical User Interfaces with Python

- ✓ Create games and fun Python programs
- ✓ Learn how to create your own graphical user interfaces
- ✓ Use windows, text boxes, buttons, images, and more
- ✓ Learn about event-based programming
- ✓ Explore good (and bad) user interface design

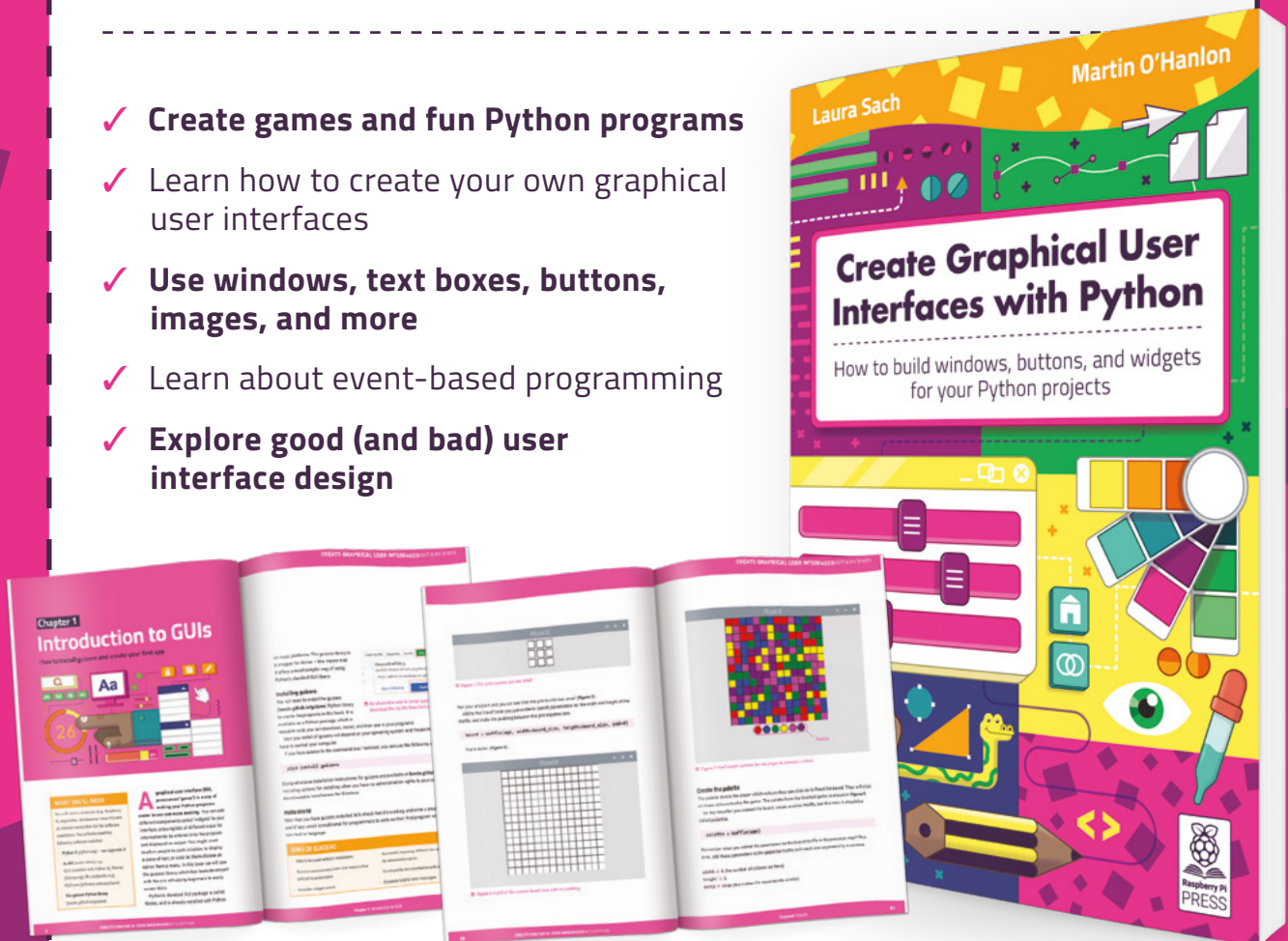

Buy online: hsmag.cc/pythongui

Finding sound and making microphones

A guide to getting experimental with the noises around us



Helen Leigh

@helenleigh

Helen turns all sorts of unusual items into musical instruments (among other things).



Sound is everywhere. Every day, in every corner of the world, we listen to a chaotic orchestra made up of natural and synthetic sounds. When we start to tune in to those sounds and listen to the world around us – the song of a bird, the clickety-clack of a train on a track, the joyful sound of a stick being dragged along railings – they can be an immense source of inspiration and delight. When sounds like these are captured in the wild, this is often called ‘field recording’ or ‘found sound’.

Found sound enthusiasts are collectors of noises, from the mundane and unpleasant to the rare and beautiful. They then repurpose these sounds, making them more structured, more accessible, or more ‘musical’. To someone interested in field recording, the bang of an empty oil canister can become a kick drum for a techno track. Rustling leaves on a windy day can be moulded into the sound of an audience whispering or into a brushed cymbal for a moody jazz ensemble. The amplified sound of ice

melting and cracking can create moody, atmospheric soundscapes. Once you start playing with found sound, the world is your sonic playground.

This tutorial is all about exploring fun, accessible sound experiments. You can get pretty far with just a mobile phone, a handful of electronic components, and the cheapest mini guitar amp you can find.

FINDING SOUND WITH YOUR PHONE

When you’re starting out, you can absolutely just record with your phone. To make it a bit easier, you can use a simple audio recording and editing app like WavePad. If you get into field recording and find that you really enjoy searching for sounds, I’d recommend getting the entry-level Zoom recorder to take your recordings to the next level.

Above Want to make unique sounds? You’ll need a unique microphone



The position and distance of your microphone and sound source are important. If possible, do a couple of test recordings or record different perspectives to give you choices. Think of your microphone as a flashlight. Imagine a dark room with a flashlight pointing at the instrument – we only point the light at what we want to see (or in this case hear), so it doesn't make sense to point the light at something else other than the instrument. The closer the flashlight is, the more concentrated the light will be and the smaller the light radius (close mic-ing), when we go farther away the light will be less concentrated but will cover a larger radius (ambient mic-ing).

Close mic-ing involves placing the microphone 10–30 cm from the sound source. This technique will produce a dryer sound with less information about the space around it. Ambient mic-ing can be any distance from 50 cm to 20 metres away from the sound. This technique will make the sound seem farther away and will give us more information about the space it is in.

Sniffing out unwanted noise before you start is also important: ventilation or electric hums like broadband noises can really mess up an otherwise beautiful recording.

Once you've figured out how to record a few interesting noises, a fun thing to do is to send yourself

“ Electric hums like broadband noises can really mess up an otherwise beautiful recording ”



on a found sound scavenger hunt. Run around your home or outside in the park and try searching for sounds or make noises using materials you find. Even a humble piece of paper can make dozens of sounds with a little applied imagination: scrunched, ripped, dropped, brushed against different surfaces, or rolled up and tooted...allow yourself to be silly and allow yourself to make horrible sounds. It's only by trial and error that you'll eventually find things you like.

Another fun thing to do with found sound is to make yourself into a Foley artist and 'fake' sound effects. Challenge yourself to make the best polar bear walking across ice sounds, the best monster noises, or the best lightsaber sounds. Making sound effects is a wonderful rainy day activity with family and friends – and there are many excellent YouTube videos about this awesome art form!

FINDING HIDDEN SOUNDS

There are many interesting sounds we can record using just our phone or an audio recorder, but there is a whole world of hidden sounds that we can uncover using a couple of inexpensive tools. Let's start with the found sound explorer's best friend: the humble yet mighty piezo. If you've done any microcontroller or electronic tinkering before, you're probably familiar →

Far Left ♦ You'll need to protect your microphone if you want to put it in liquids

Left ♦ A melting block of ice makes some fascinating sounds

YOU'LL NEED

TOOLS

- ♦ Soldering iron (optional, see step one)
- ♦ Wire-cutter/stripper
- ♦ Drill or awl
- ♦ Scissors
- ♦ Lighter

MATERIALS

- ♦ Two embroidery hoops, one large (25–30 cm) and one medium (10–15 cm)
- ♦ Eight bulldog clips, four large and four small
- ♦ Pre-wired piezo (see step one)
- ♦ 6.35 mm mono audio jack or jack input (optional, see step one)
- ♦ Plastic circle (I used a relatively stiff lid from an empty plastic pot)
- ♦ Heat shrink or electrical tape
- ♦ 2 m length of stranded wire
- ♦ Elastic cord
- ♦ Sticky tape

Finding sound and making microphones

TUTORIAL

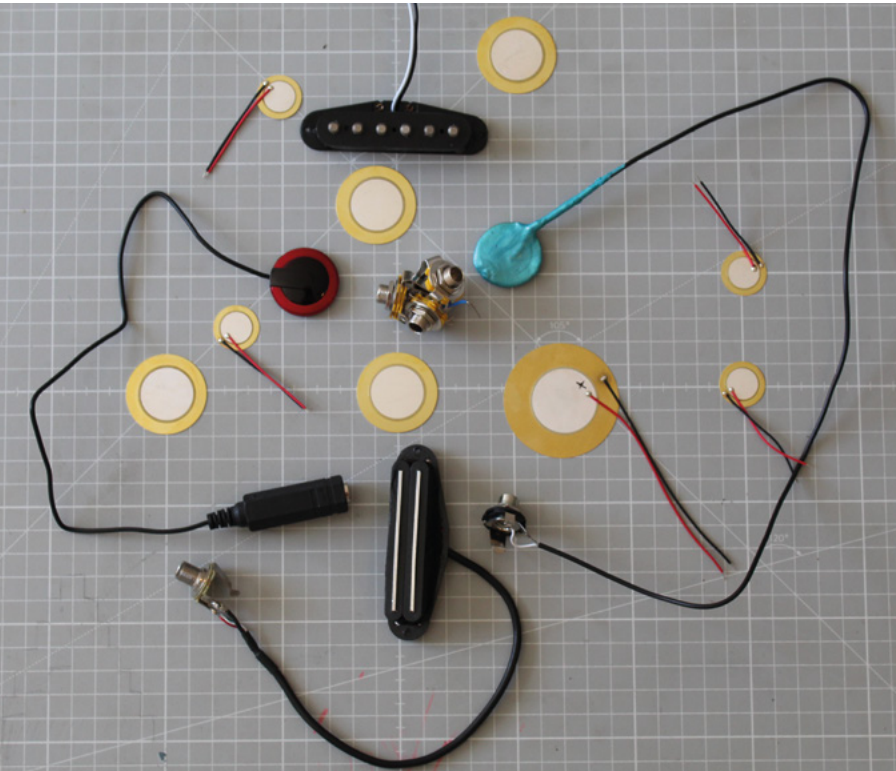

Above ♦ Microphones and pickups come in all shapes and sizes

Below ♦ What sounds can you find in everyday objects?



with piezos already, either in plastic casing as a tiny buzzer, or as a flat disc, often used as a ‘knock’ or vibration sensor.

Piezoelectric materials produce voltage when subjected to pressure. This voltage can be converted into a sound signal. We can stick piezos on things that vibrate, and listen to the sounds of those vibrations. Often referred to as contact mics, piezos are commonly used to amplify acoustic instruments including banjos, violins, and guitars. There have been entire books dedicated to the craft of contact mics and their role in found sound, but I hope that over the next few pages I can give you a taster of some of the sonic joy that can be had with this cheap component.

When buying a piezo to use as a contact mic project, you’ll have a number of different options to choose from. You’re going to need a disc piezo without a plastic casing. You should also get one with pre-soldered wires unless you’re already a pro at soldering: the delicate crystals on the piezo can crack really easily. If you do want to have a go at soldering your own piezo, I’d recommend buying a few so that you don’t end up with a broken piezo and nothing to play with.

You’ll also have a choice of size. They are pretty cheap components, so I’d recommend experimenting with a few different sizes to see which you like best. Finally, some piezos are not only pre-soldered on the piezo end, but come with a guitar cable-sized jack input (6.35 mm or ¼”) pre-soldered on as well. For these contact mic experiments, I used some 3 cm contact mics with pre-soldered wires and a pre-soldered jack.

Once you have your basic piezo set up, you’re going to need a way to amplify it. I plugged mine into my guitar amp. You can get cheap practice mini guitar amps online for around £10–15. You can also choose to go even more DIY, and purchase a preamp kit plus a little speaker from any hobbyist electronics store.

One other thing many found sound explorers like to do with their piezos is to coat them in something protective. Spend a few minutes searching online, and you’ll find loads of detailed blog posts about the different ways to treat your piezo, depending on what you want to do with it. I like to make my piezos waterproof so that I can use them to listen to all sorts of fun watery things. To do that I mix liquid latex with some brightly coloured acrylic paint, then dip my piezo into the mixture before pegging it onto the side of a jam-jar and letting it dry. Once dry to the touch, I dip and dry three or four times. This gives me a brightly coloured, reusable waterproof mic. If you don’t mind sacrificing the look and toughness of the liquid latex, you can always make a waterproofed contact mic on the fly with a thin latex glove (or similarly leak-proof material) and some tightly wrapped tape.

“ My favourite watery sounds happen when you freeze a cup of water and slowly let it thaw out ”

Once you have a waterproofed piezo, you can start experimenting with watery sounds. Simply pouring water on top of it and blowing bubbles is great fun, as is swishing water around and running it under a tap. My favourite watery sounds happen when you freeze a cup of water and slowly let it thaw out. The tiny cracks of the ice when it starts to melt can make atmospheric, almost alien soundscapes.

It’s not just water, though. Contact mics are great for experimenting with anything that has any kind of vibration. Use double-sided tape or removable sticky tack to place your piezo. Always place your piezo with the crystal ‘face’ in contact with the vibrating surface to get the best sounds. You never know from your own ears what is going to sound excellent or what will be a sonic dud – you just have to stick

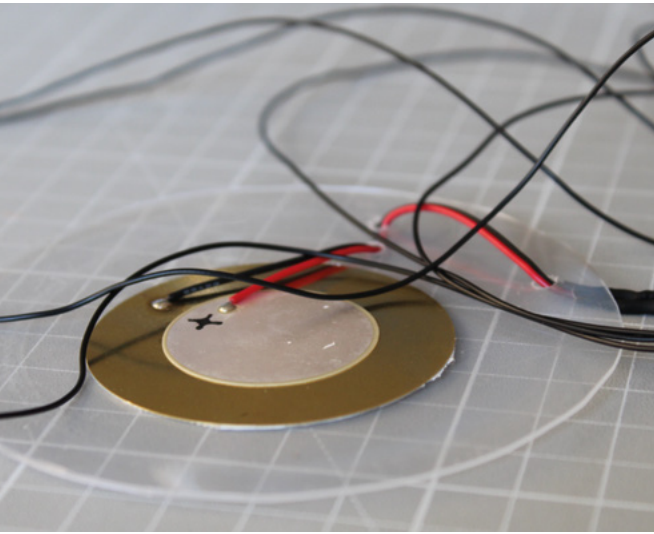

on your mic and see! I've gotten some delightful sounds from slowly unrolling sticky tape, tapping it rhythmically, or playing it with a bow. Other physical objects you can try sticking your contact mic to are metal railings, a window (or the roof of a tent!) during a rainstorm, assorted sizes of springs, or my personal favourite, the children's toy Slinky. Listen to a Slinky just right and you'll be rewarded with a sci-fi laser battle – pew, pew, pew!

Piezos let you listen to the hidden sounds of vibrations, but if you want to listen to hidden electric sounds, you're going to need an electromagnetic pickup. I use a dual-rail pickup from a broken guitar that I bought for next to nothing on eBay. Once you've got your hands on a pickup and soldered on a jack, you can plug it into your mini amp and go searching for sounds. Turn on some household appliances, for example, your microwave, and sweep your pickup over it to find strange sounds. If, like me, you don't mind looking a bit peculiar in public, you can head out into the street and find more electric sounds – ATMs, self-checkout machines, and ticket barriers can all make for interesting listening!

EMBROIDERY HOOP PIEZO MICROPHONE

My other favourite thing to make with piezos is this rather attractive, but budget-friendly, vocal mic.

STEP ONE PREPARE YOUR MATERIALS

Choose a piezo with pre-soldered wires. Regarding size, for my own mic, I used the biggest piezo my local electronics store sold, but this project will work with pretty much any sized piezo. For this project, I chose to solder on my own jack instead of buying one with a pre-soldered jack for aesthetic and weighting reasons but, especially if you don't have easy access to a soldering iron, a pre-soldered piezo kit is a perfectly good option.

STEP TWO PREPARE THE PLASTIC DISC

Your piezo will be secured on a plastic disc. I used a scalpel to cut off the raised sides of a plastic lid, but you can use anything you can scavenge, as long as the plastic isn't too flimsy. Place your piezo in the centre of your plastic disc and use a pen to mark two or three spots that you can weave your wires through. The crystal 'face' of the piezo should be facing towards the plastic disc.

Next, use a drill or awl to make small holes in the plastic disc in the locations you just marked out. Remove any rough edges, then thread the piezo wires through these holes. This will secure your wires in place so that any movement of your microphone leads will not stress the fragile solder joints on the piezo.

Once you're happy with the placement of your piezo, use sticky tape to secure it in place. Remember to make sure the crystal 'face' of the piezo is attached to the plastic, not the other way round. Trim off any tape at the edges of the plastic disc.

STEP THREE SOLDER THE WIRES

If you chose to use a piezo with a pre-soldered jack, you can skip steps three and four.

The delicate little wires on a piezo can be fiddly to solder to another wire, so I'd recommend using a set of helping hands to make your life easier. Apply a little bit of solder to the two exposed ends of the piezo wire. This is a process called tinning: putting a little solder on the end of stranded wires holds the fine wires together and makes it easier to connect them. Next, cut two 1 m lengths of stranded wire and strip →

Left ■ Attaching the piezo to a disc makes it easier to mount

Below ◆ In making and in life, Sharpies are your friend

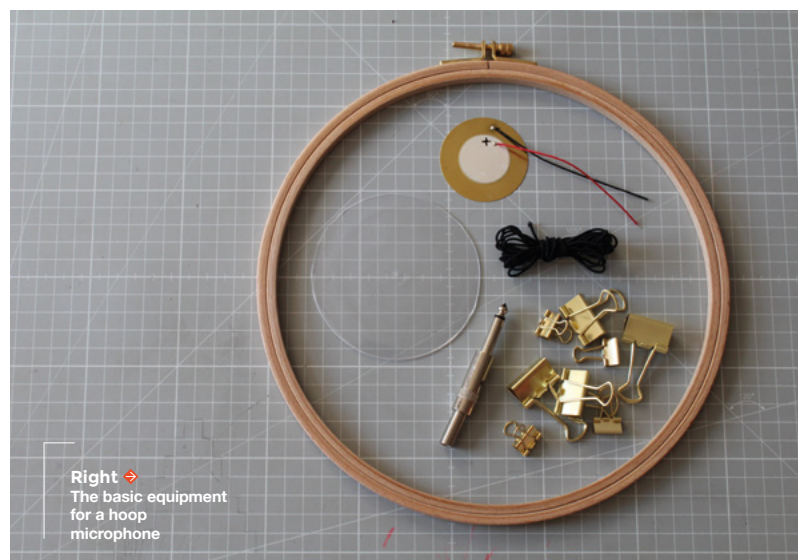

Right → The basic equipment for a hoop microphone

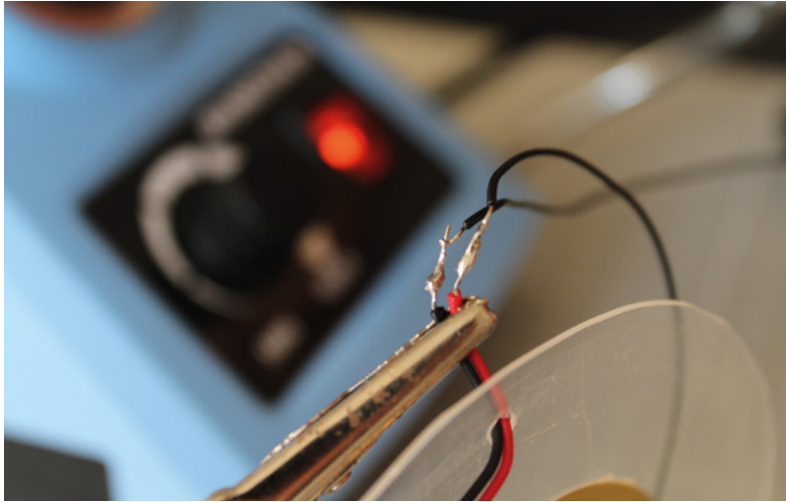

Above ♦
Take care when handling the delicate wires from piezos

1–2 cm off the end of each. Again, tin both exposed ends to make it easier to connect them.

Wrap the tinned end of the piezo wire and the tinned end of the length of wire around each other and solder them together. This can be a little fiddly, so using a set of helping hands to keep things where they should be while the solder cools is super-helpful. I've also used tweezers to help me out in similar situations before. Follow the same procedure for both the wires.

Once they are both soldered up, you need to insulate the bare bits of wire so that they don't touch each other and mess up your circuit. You can use a little electrical tape for this, or if you want to make it look extra tidy, you can use heat shrink. Heat shrink is a magical material that does what it says on the tin: it shrinks when you heat it. You get it in little tubes which you can slip over your exposed wires, then use a lighter to heat it up until it neatly conforms to your wires. Just remember to put it on before you solder both sides of your wire – a classic mistake even the most experienced electronics engineers curse at themselves for forgetting from time to time!



Right ♦
Soldering the two wires to the mono jack

STEP FOUR SOLDER THE JACK

Unscrew your mono jack and open it up. You should find two prongs, or poles, each with little holes. The long pole is the sleeve, or ground, and the little pole is the tip, or signal. Lots of people ask if the polarity of the piezo matters here, or put more simply, if it matters which piezo wire gets connected to which bit of the jack. In this project, it doesn't matter which way you connect it. However, it is a good habit to always connect the ground (black wire) to the ground pole. With a piezo to jack connection like in this mic, it isn't a problem, but as you move on to more complex projects, it makes troubleshooting easier if you are consistent.

Thread both wires through the unscrewed part of your mono jack, so that you can screw it all back together once you've done your soldering. Strip 2 cm of wire from one of the lengths attached to your piezo. Thread the bare wire through one of the poles and wrap it securely around itself, forming a tight little loop. Solder this loop in place to the pole, then repeat this process for the other wire. Trim off any excess wire and, if necessary, wrap any exposed wire in a little electrical tape to prevent unwanted touching. Finally, screw your mono jack back together.

STEP FIVE ATTACH YOUR BINDER CLIPS

Take the four large bulldog clips and attach them to the larger embroidery hoop so that the hoop is 'split' into quarters. Place your hoop on a flat surface then put your plastic piezo disc in the centre of your embroidery hoop. Next, take the four small bulldog clips and attach them to your plastic piezo disc so that it is also divided into quarters. You'll need to offset the positioning of the large and small bulldog clips so that they lie in the middle of each other. You can always fiddle with the positioning so that it sits correctly and looks the best later on, so don't worry about getting it perfect at this stage.

STEP SIX SUSPEND YOUR PIEZO DISC WITH ELASTIC

Thread some elastic cord through one of the large bulldog clips and thread it through one of the small bulldog clips, then tie the cord to itself, forming a loop. Repeat this process twice for each of the clips so that the plastic piezo disc is suspended in the centre of the embroidery hoop. You'll probably need to cut and retie the elastic loops a couple of times to get that perfect suspension – not too tight, not too loose, and attractively centred. You can also fiddle about with the positioning of the bulldog clips at this stage to get everything looking and working just right.

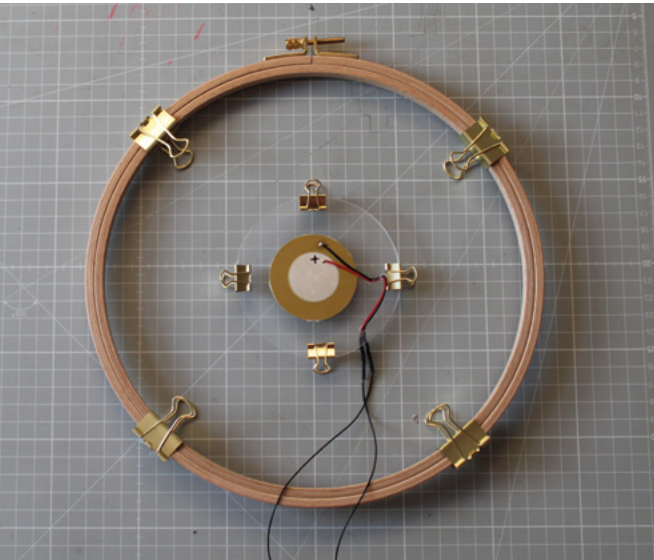

Far Left ♦
Laying everything out, ready for final assembly

Left ♦
You need to boost the output through a guitar or other amplifier



it will distort. Once you're happy with the gain level, you can turn up the volume as needed. Once you've got it working, you can try playing with effects. A little delay and a little reverb turn the warm, old-fashioned sound of this DIY mic into something pretty special. Have fun!

STEP SEVEN PLAY!

Once you're happy with your embroidery hoop microphone, it's time to test it. The simplest way to do this is by using a standard guitar amp. Secure your hoop somewhere you can sing into it. I suspended my hoop using transparent wire, but you can clamp the hoop onto a mic arm, or simply hold it. Next, plug the jack into your amp – making sure the volume and gain are turned all the way down before you turn it on. The piezo can make a super-loud noise if it knocks against something, and we don't want it blowing your amp!

Now try singing into your mic, while gradually increasing the gain and volume on your amp. On my amp, I got the best results at 20% volume and 40% gain, but you'll need to work out your levels using trial and error here, as every amp is different. Just please don't go too far, then drop your mic, or you might damage your amp – or your eardrums!

Best practice is to adjust the gain stage first before the volume so that the signal you're intercepting is the best it can be. Don't turn the gain up too high, or

STEP EIGHT MAKE A MATCHING POP SHIELD

A pop shield is used in recording to stop plosives, the physical blasts of air that come from your mouth when you say or sing a hard letter, including T, P, or B. This air can overload your mic, making an unpleasant 'pop'. A pop shield spreads out that blast of air, keeping your plosives from ruining your recording. If you're using your embroidery hoop mic to record and you can hear those pesky pops, here's how to make your own pop shield.

Take an old pair of tights. I used 30 denier, but as long as your tights aren't too thin or the woolly winter type, you can just use whatever you have to hand. Loosen your embroidery hoop using the screw at the top and push out the inner hoop. Pull one leg of the tights over the inner hoop, then secure with two knots. Trim the excess material, put your outer hoop back on and tighten the screw. That's it! Position your pop shield a few centimetres in front of your microphone and enjoy your new, improved, pop-free vocals. □

Left □
All wired up and ready to catch some sound

Below ♦
You can also use a microphone hoop for embroidery



DON'T MISS THE BRAND NEW ISSUE!



SUBSCRIBE FROM JUST £5

- FREE! 3 issues for the price of one
- FREE! Delivery to your door
- NO OBLIGATION! Leave any time

**FREE PI ZERO W
STARTER KIT***

With your 12-month subscription to the print magazine

magpi.cc/12months

* While stocks last



**WORTH
£20**

Buy online: store.rpipress.cc

FIELD TEST

HACK | MAKE | BUILD | CREATE

Hacker gear poked, prodded, taken apart, and investigated

PG
106

DIRECT FROM SHENZHEN:

BELT GRINDER

Can a mini grinder be useful in the workshop?



PG
108

COMPUTE MODULE 4

A Raspberry Pi board for building your own products



PG
110

RASPBERRY PI 400

Eben Upton recreates his childhood computer



PG
100

BEST OF BREED

The world of Tindie - a treasure-trove of maker kits and bits



PG
112

NVIDIA JETSON NANO 2GB

Getting started with AI just got cheaper

ONLY THE
BEST

Our favourite kits and products from Tindie

The best bits from the maker marketplace

By Marc de Vinck

 @devinck

Tindie is an online marketplace that caters to the DIY technology crowd by offering mostly boutique and small-batch manufacturing storefronts for indie hardware creators. You can find hundreds of

items for sale in the basic categories of electronics, 3D printing, sound, IoT, camera equipment, and more. It's an interesting community filled with a lot of unique products from people all over the world.

The site claims to have shipped over 198,000 items, and has 10,500+ products listed. Just keep in mind that they include the 'supplies' section and 'flea market' which has a lot of interesting items, but also a lot of things that are easily sourced elsewhere and not made by indie creators. However, this author did find some bargains on a few stepper motors, and other common products, so it's definitely worth a look.

But what we really like about Tindie is the everyday enthusiast with a storefront. The person who, after they make a cool project, decides to make a few more kits and offer them for sale.



Or, someone who tries an open-source project, but found it really difficult to source a component, so they source the parts in bulk, and sell a kit that is more convenient for the end-user. There are a lot of speciality kits, and just plain odd things too. And that's what this Best of Breed looks at. It's a few of the many interesting and unique projects available on Tindie.

6 Key Macro Keypad Pro vs ESPboy

PHOENIX CNC ◆ \$72.95 | tindie.com

ESPBOY ◆ \$89 | tindie.com

The 6 Key Macro Keypad Pro with Rotary Encoder and Display by Phoenix CNC is a great example of an interesting and useful kit available on Tindie. Yes, you can buy a Stream Deck

for a little more money and have a bunch of fancy display buttons, but we like the extensibility of this keypad just as much, if not more in some circumstances.

In addition to the six programmable keys, all of which you can customise the colours and add key combos, is the very handy rotary encoder. We really like being able to interact with a scroll wheel controller for things



like scrubbing a timeline or adjusting the audio level while working. In addition to this feature, there is a convenient built-in colour display. We also like the LEDs around the edge which can react with what you are controlling in real time.

The creator uses it for working with EAGLE, and he posted a video of it in use on the product website. It looks like a great use case! He also shows how to use it with a PC performance monitor program running on the colour screen, which again could be very useful. That's not something that I think you can do with other external controllers, at least not that easily.

Left ◆
Add a scrolling input

Below ▣
On the go gaming, IoT and anything else you can do with an ESP32

The ESPboy is another fascinating project that is a lot more than just a simple gaming device. Sure, you can run a bunch of classic arcade games on it, and we assume a lot of people will pick one up just to do that, but it's much more capable and useful.

In addition to being able to play games from a variety of arcade systems, you can also use the ESPboy to create chip synth music, or listen to the MP3s and WiFi radio. And what really interested us in this kit is the ability to do some basic WiFi and packet sniffing processes. You can even surf the internet in an old-school browser, or connect to any of the dozens of IoT services such as ThingSpeak, CloudMQTT, Temboo, IFTTT, and more.

For an on-the-go little gaming system, it's great. And if you need added capabilities, you can easily add more features, making this device really helpful

in a variety of use cases. To fully understand all the capabilities of the ESPboy, you really need to head over to the website to read up on what it can do. We found that the more we research it, the more interesting features we discover. [→](#)



VERDICT

6 Key Macro Keypad Pro [→](#)

Very useful for creating custom macros.

10/10

ESPboy

More than just a tiny gaming system.

9/10

Keyboard FeatherWing

SOLDER PARTY ♦ \$55 tindie.com

Here at HackSpace magazine, we're big fans of the Feather ecosystem of microcontrollers that Adafruit created some time ago. One of the nice things about open-source hardware is the ability for anyone with enough talent and time to create additional accessories for a product, and that's exactly what Solder Party has done.

The Keyboard FeatherWing is a deluxe wing-type accessory for the Feather board. It adds a full QWERTY keyboard, five-way button, four tactile buttons, a NeoPixel, microSD card-holder, and a full-colour 2.6" LCD. You simply plug your favourite Feather board into the back, and you add all those capabilities in seconds. So easy!

What really caught our eye was the keyboard and overall design of the PCB. It's beautiful and falls right in line with the aesthetics of the typical Feather board. So many times, you start a project and you immediately add some buttons and a much-needed screen. With this fully assembled board, you get that, and a whole lot more. And all for what I think is a very reasonable price.

//

What really caught our eye was the keyboard and overall design

//



Above ■
Because touch screens are rubbish

VERDICT

Keyboard FeatherWing

A beautifully designed Feather add-on.

10/10

DM – Solder paste and adhesive dispenser

DAN M ♦ \$139 | [tindie.com](https://www.tindie.com)

Below ♦
Precisely dolloped
blobs of solder

We've seen a few different solder paste dispensing systems out there for the DIY enthusiast, but this system, from Dan M on Tindie, looks much more robust and

extensible. And unlike most other dispensers, this one can double as a vacuum pump pick-and-place attachment. Although it seems a little bulky for that application, we can see how this would make for a great platform to start automating the process with an unused 3D printer. But for dispensing precise amounts of solder on a PCB, even by hand, this looks like a great system that is well worth the money.

Recently we have been doing a lot more surface mount soldering – having a precision dispenser like this would have been really handy. The creator custom makes the syringe parts from solid brass and nylon for added strength, better concentricity, and less friction and backlash. This added precision is a much-needed improvement over other systems available.

If you do some short-run manufacturing in-house, or just like to prototype with surface mount components, this kit looks like a great addition to your workbench. Just don't forget to pick up the optional foot switch and extra pistons and tips. →

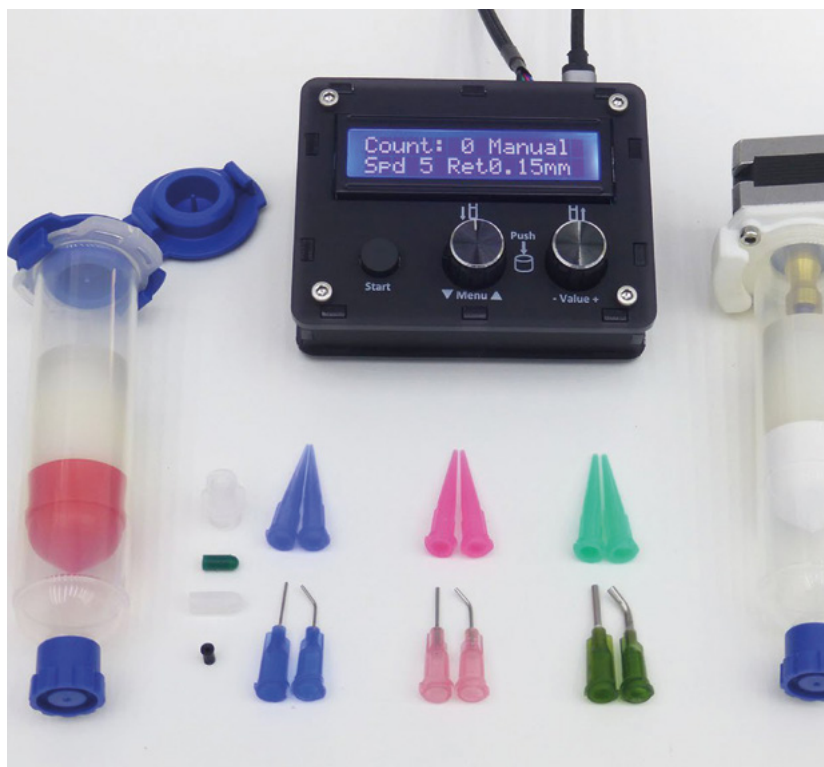

BB Q10 KEYBOARD PMOD

SOLDER PARTY ♦ \$13.50 | [tindie.com](https://www.tindie.com)

You may not need all of the features on the Keyboard FeatherWing, but you can't help but want that keyboard! Well, the folks over at Solder Party didn't forget about you. The BB Q10 Keyboard PMOD is a nice little QWERTY keyboard that's ready to be hooked up to your next project. It's affordable and easy to use. If you need a keyboard for your next project, definitely check it out.



VERDICT

DM – Solder paste and adhesive dispenser

When you do a lot of SMD soldering, this is really handy.

8/10

exixe: Miniture Nixie Tube Driver Modules

DEKUNUKEM ♦ \$11.99 | tindie.com

Nixie tubes are notoriously difficult to control and use, and that's where the **exixe: Miniture Nixie Tube Driver Modules** come into play. These breakout boards simplify the process of using Nixie tubes by eliminating the need to source vintage driver ICs and multiplexing circuits. Instead, you can easily control every segment of the display via SPI, including an RGB backlight. The creator supplies an Arduino library, making this a no-brainer if that's your choice for a controller. And if you are using a Raspberry Pi, it

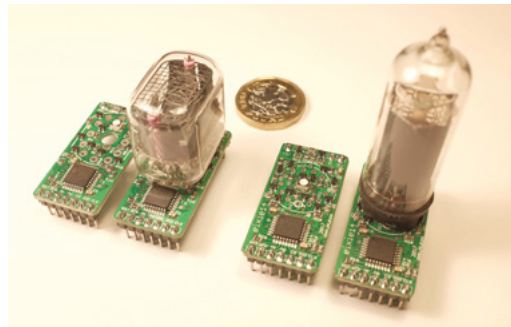

Left ♦
Retro blinking lights

VERDICT

exixe: Miniture Nixie Tube Driver Modules

A simple board that makes using Nixie tubes much easier.

8/10

shouldn't be too difficult to use either. There is something so alluring about vintage Nixie tubes, and now you can add that little bit of nostalgia to your next project a lot easier, thanks to this handy little board.

Core Memory Shield for Arduino

JUSSI KILPELÄINEN ♦ \$39.90 | tindie.com

Jussi Kilpeläinen created a **Core Memory Shield kit for Arduino after being inspired by the Memory Shield Project built by Ben North and Oliver Nash**. Even when a build is well-documented for others to recreate, sourcing all the parts to build one for yourself can be time-consuming and very difficult. This kit alleviates all those issues by providing everything you need to build your own example of a 32-bit ferrite core memory module.

So why would you want to build a memory core that was designed in the 1950s? Simple! It's a fascinating and beautiful look into the history of computing. Sure, there are much more robust memory ICs out there, but are they beautiful? We really like the looks of this PCB and the ferrite cores floating around finely looped

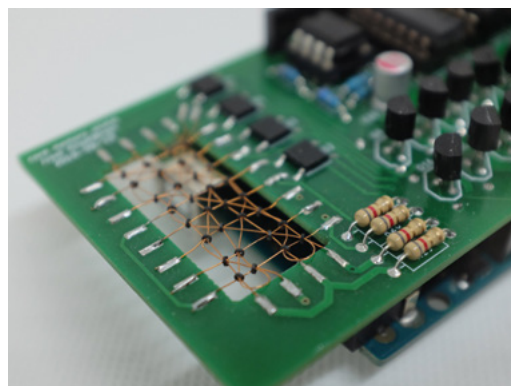

Left ♦
Old school Arduino

VERDICT

Core Memory Shield for Arduino

A very unique shield!

8/10

wires. And the fact that it actually works is a bit magical. So, why not add a little memory to your next Arduino project in a very old-school way?

And if soldering isn't your thing [Gasp!], then he also offers a fully soldered-together version for an additional fee. But honestly, that takes all the fun out of it! □

GET STARTED

WITH

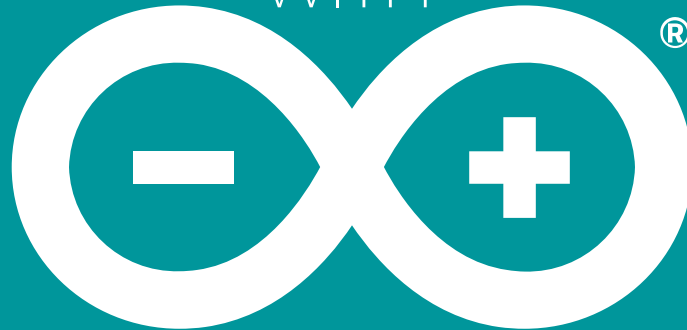

ARDUINO

Robots, musical instruments,
smart displays and more

£10
with **FREE**
worldwide
shipping

Inside:

- Build a four-legged walking robot
- Create a Tetris-inspired clock
- Grow veg with hydroponics
- And much more!



**AVAILABLE
NOW**

hsmag.cc/store

plus all good newsagents and:

WHSmith

BARNES & NOBLE



Available on the
App Store



GET IT ON
Google Play

FROM THE MAKERS OF **HackSpace** MAGAZINE

Stationary belt sander

A miniature version of this essential knife-making tool

By Ben Everard

[@ben_everard](#)

Below

The construction – from stainless steel sheet – feels robust and sturdy

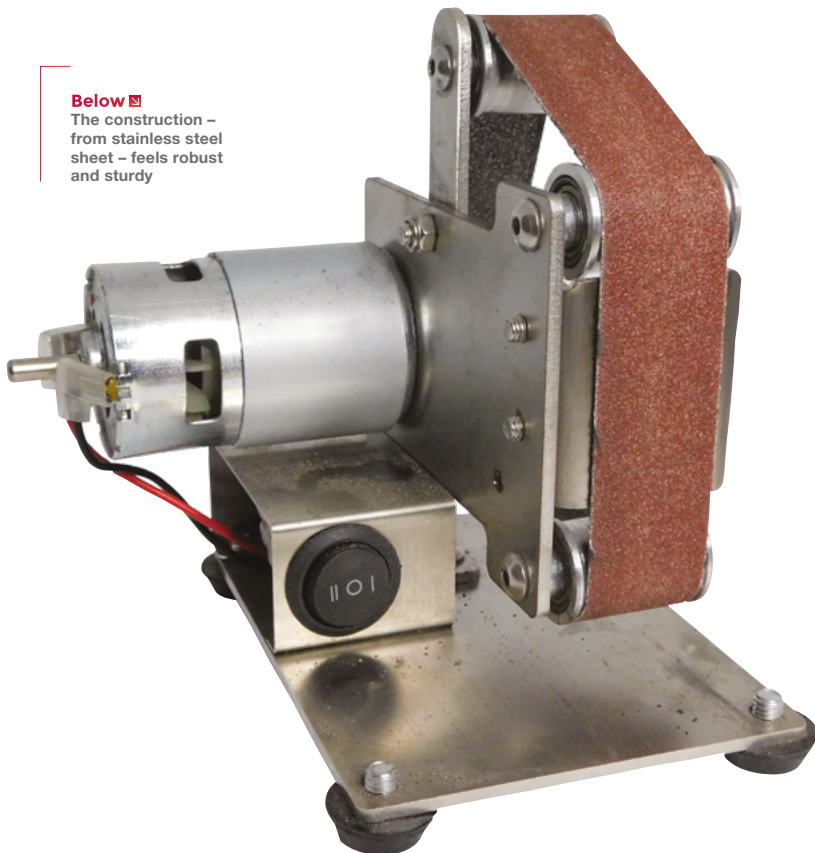

M

achines that stand on your bench and whip loops of sandpaper around are known as bench grinders or stationary belt sanders, depending on what they're designed to do. They're

used by woodworkers because they're good for cleaning up cut wood. However, they're probably most useful for working with metal – they're heavily used for knife making, and can also be used for tool sharpening. Typically, they take long loops of sandpaper (around one or two metres long) and drive this with a powerful motor. They can aggressively remove large amounts of metal. However, they're also expensive tools. You can get this function for a fraction of the cost with a mini bench grinder. Similar models are available from many direct-from-China websites. The model we got was a 'KKmoon Multifunctional Grinder Mini Electric Belt Sander DIY Polishing Grinding Machine Cutter Edges Sharpener Power Tool' from the Chinese-Dragon Tool Store on AliExpress. It contained ten sanding belts in a variety of grades, and cost £36, including delivery to the UK.

It takes 25 mm × 330 mm sanding belts (some options also have 15 mm or 30 mm wide belts). Perhaps the first thing to note is the cost of replacement belts. While some deals are available if you look, it's quite common for ten replacement belts to cost half the price of the bench grinder itself!

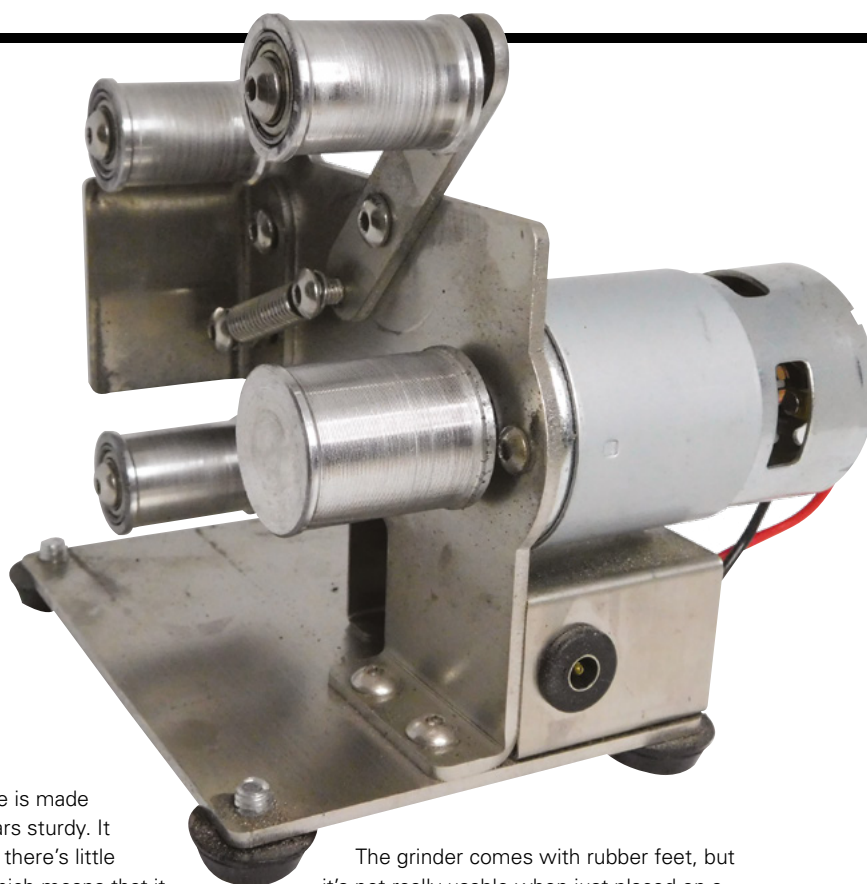

Left  Just supply 12V to 24V via the jack to make your sandpaper spin

The frame of the machine is made of stainless steel and appears sturdy. It feels solid in use; however, there's little protection for the motor, which means that it could get damaged or short-circuited if you're not careful. The unit itself takes a 5.1 mm DC barrel jack for power. Our machine came with an additional power supply, though not all do. The provided power supply is adjustable between 12V and 24V, and this provides a rudimentary speed control.

Our main test of this machine was grinding a bevel on a stainless steel chef's knife we're making. Compared to a full-sized (or even a moderately small) belt grinder, this is quite underpowered. However, with a little patience, it did do the job. Push too hard and you can slow the motor down too much, so it's a case of light pressure and taking your time. This reviewer finds slowly grinding bevels quite a peaceful experience, so is quite happy to take a little time over it. However, if you've got a stack of things to shape, then you might find it more annoying.

There's a small plate that you can grind against, and an adjustable rest for holding your workpiece. However, the adjustable rest can only hold about 10 degrees either side of 90 degrees, which may be useful for putting a nice sharp corner on wood, but it's useless for bevelling a knife. We ground our bevel free-hand, but if you were to use this grinder a lot, you may wish to build your own jig to hold your workpieces.

The grinder comes with rubber feet, but it's not really usable when just placed on a bench – it jumps around too much. We found that we had to clamp it down, but the clamps made it a little difficult to work around. A far better, and more permanent, solution would be to use the holes that the rubber feet screw into to bolt it down to either your workbench or a larger surface that you can then clamp down with ease. This would also give you space to attach a jig for holding workpieces at precise angles for bevel grinding and sharpening.

This isn't comparable to a regular bench grinder. It's much smaller and much less powerful. That said, neither of those factors are necessarily a problem – it depends on how you want to use your machine. For sharpening tools, adding too much power can result in removing too much material and the steel becoming overheated (leading to it losing hardness). A machine such as this could – with the addition of a jig to help hold tools in position – make for a good sharpening setup. However, if you want to use it for heavy-duty grinding, or quickly shaping metal, you'll probably be disappointed. Similarly, if you want to square-off pieces of wood, you might prefer a sander with a wider belt.

Our workshop sees only occasional metalwork, and as such, a little belt grinder like this serves a purpose that we couldn't easily fill otherwise. 

// The provided power supply is adjustable between 12V and 24V, and this provides a rudimentary speed control

//

DIRECT FROM SHENZHEN

Raspberry Pi Compute Module 4

The easy way to build your own Linux-powered products

RASPBERRY PI ♦ \$25 | raspberrypi.org

By Ben Everard

@ben_everard

So, you've built a fantastic Raspberry Pi-based project. It's small, neat, and makes your life easier. The only thing left to do is make your fortune selling it. How do you turn your one-off project into a product? The first problem you have is that Raspberry Pi Model A and Model B boards aren't really designed for products: SD cards aren't a great choice for long-term embedded use; the board itself is loaded up with a bunch of features you probably don't need (those USB ports, for

starters, are unlikely to be needed in your embedded project); the power supply may not be suitable ... well, there's a long list of things that make Raspberry Pi Model A and Model B boards not quite the right choices for putting in products you want to sell. Fortunately, there's a solution: the Raspberry Pi Compute Module 4. This takes the essential heart of other Raspberry Pi 4 models, and puts it in a package suitable for building commercial things.

The newly launched Compute Module 4 brings this line of products bang up to date with the flagship models. It also introduces some new features – the most obvious of which is the connector which is now a pair of high-density connectors that push securely into connectors on another PCB.

A big advantage of the Compute Module 4 over the standard Raspberry Pi models is that it gives you much more choice over what you get on the board, from 1GB RAM with no wireless networking or eMMC storage (\$25), all the way up to 8GB RAM with wireless networking and 32GB eMMC storage (\$90).

Another significant advantage is that a considerable amount of compliance testing has already taken place. This means that if you build a project with the Compute Module 4, you'll need to do less testing to pass major certifications (such as FCC and CE). The exact implications of this will vary depending on what you're doing with the Compute Module 4; however, you can find more information at hsmag.cc/U6zncj.

Below ♦
Just the bare essentials you need for a working Raspberry Pi 4-based system

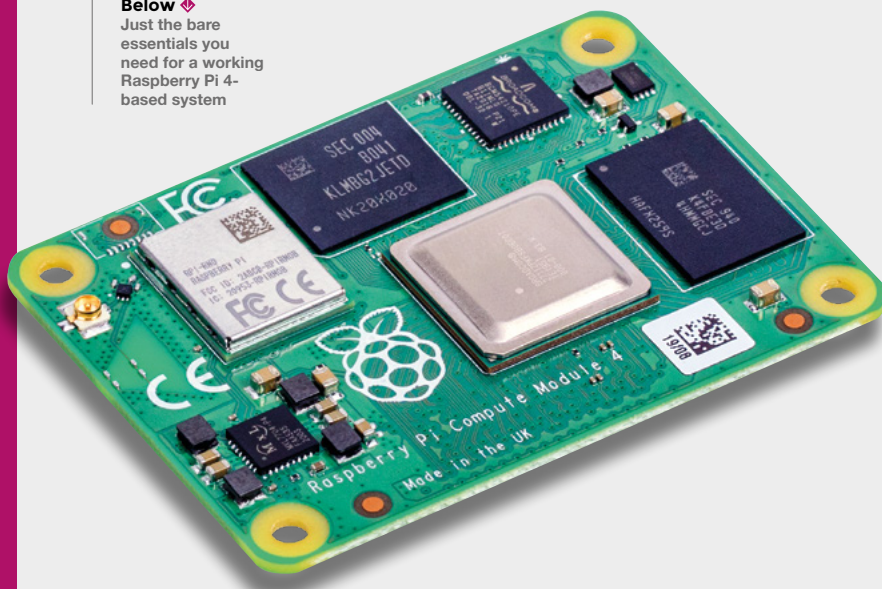

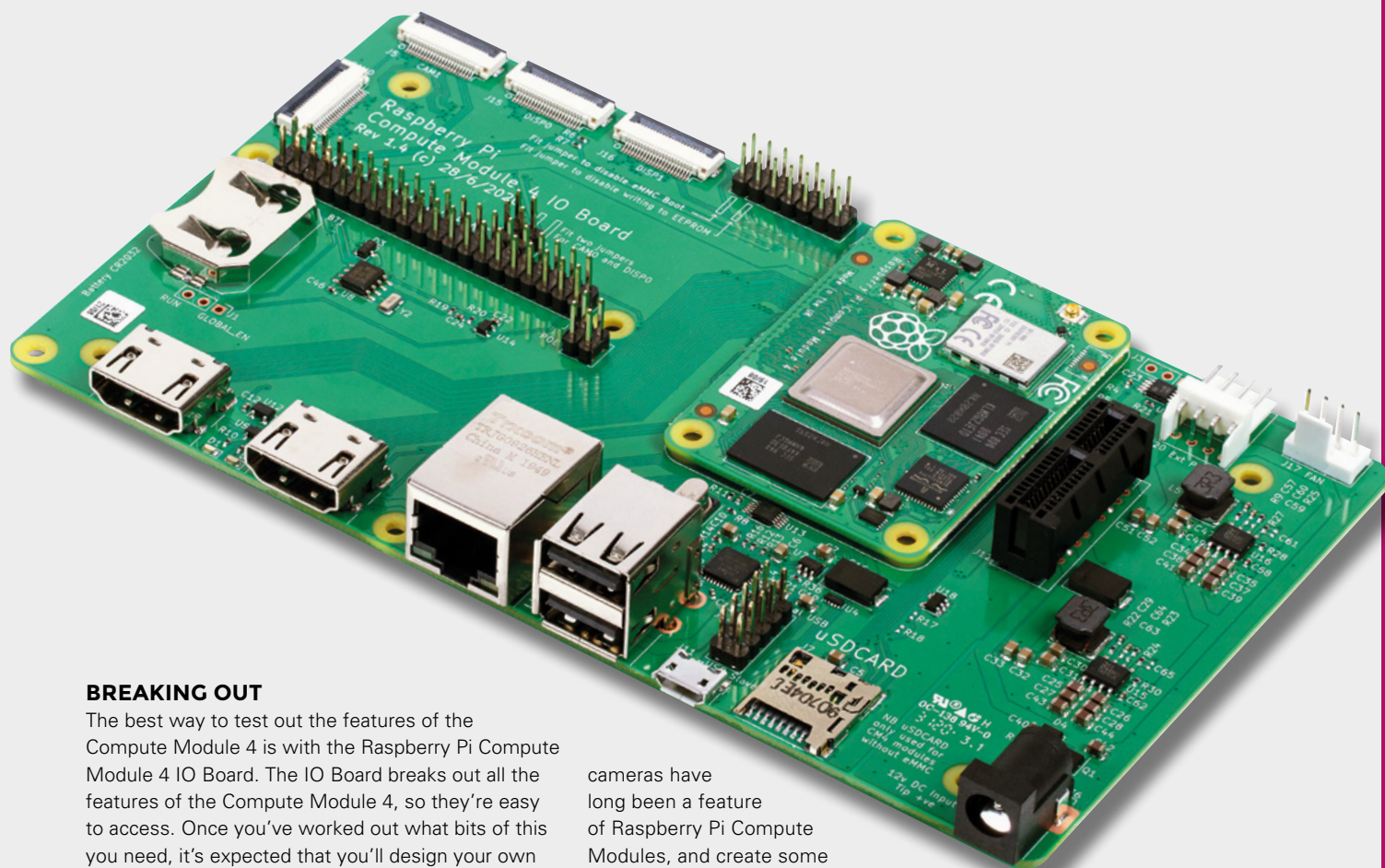

BREAKING OUT

The best way to test out the features of the Compute Module 4 is with the Raspberry Pi Compute Module 4 IO Board. The IO Board breaks out all the features of the Compute Module 4, so they're easy to access. Once you've worked out what bits of this you need, it's expected that you'll design your own carrier board that strips out the bits from the IO Board that you don't need. To make this process easier, Raspberry Pi has released the KiCad files for the IO Board (you'll need the latest version of KiCad to use them). You can modify this design however you want, and use it as the basis for your products.

“ The newly launched Compute Module 4 brings this line of products bang up to date with the flagship models ”

There are a couple of features broken out of the IO Board that aren't available on Raspberry Pi Model A and Model B, including a second display and camera connectors, plus a PCIe M.2 slot for extra hardware. All of these create some interesting possibilities, but in different ways. Perhaps the extra display slot is the least interesting because it's already possible to run two displays via HDMI, but this simplifies the hardware necessary because you don't need an HDMI driver on the display. Dual

cameras have long been a feature of Raspberry Pi Compute Modules, and create some fascinating possibilities for stereoscopic vision projects.

The Compute Module 4 is the first Raspberry Pi project to have an accessible PCIe slot – this significantly increases the range of hardware available for this board. This includes fast disk drives, fast networking, and other add-ons (Jeff Geerling is trying to get external GPUs working, but at the time of going to press, hasn't quite managed it: hsmag.cc/KwU239). This is the port that the USB 3.0 bus is connected to on Raspberry Pi 4 Model B, so on the IO Board, the PCIe is broken out, and there's no USB 3.0. However, you can add a USB 3.0 card to the PCIe if you need this functionality.

The Compute Module 4 probably won't be directly relevant to everyone, but it does show an important fact about the Raspberry Pi ecosystem – that it covers almost the entire range of computer use. It's used to teach beginners about computing both in schools and elsewhere, and it's also used in industry to design and build products. For users, this means that Raspberry Pi skills aren't just for playing around in your free time, they're increasingly important professional development skills. □

Above ♦ The two high-density connectors create a solid connection between the boards, but there are also mounting holes if you need a more robust link

VERDICT

The most flexible board from Raspberry Pi for building your own projects, or accessing all the features.

10/10

Raspberry Pi 400

1980s computer design brought up to date

RASPBERRY PI ◆ \$70 | raspberrypi.org

By Ben Everard

 @ben_everard

Raspberry Pi computers are stripped bare. You get a PCB with all the processor, memory, and connectivity, but, to get a fully working computer, you need to add a case, microSD card, keyboard, monitor, and power supply.

Well, not any more, as Raspberry Pi 400 bundles the processor – and indeed all the electronics – from a Raspberry Pi 4 into a keyboard. As such, it's reminiscent of a Commodore 64, BBC Micro, or whatever your favourite 1980s nostalgia machine is.

To use, a Raspberry Pi 400 is exactly the same as a Raspberry Pi 4 Model B. We won't go through all the specs and experiences of using it as a desktop machine, other than to say it performs excellently for most tasks. If you're wondering about how a Raspberry Pi-based machine performs as a daily driver, The MagPi magazine took a more detailed look at what it means to run a Raspberry Pi as a main desktop computer here: magpi.cc/85.

Raspberry Pi 400 has 4GB of RAM, so that's not as much as the highest variant of Raspberry Pi 4 Model B (which has 8GB), but it's plenty for almost all usual desktop use. If you really need to squeeze every drop of performance out of your Raspberry Pi computer, you may need to stick to using a discrete board for now.

Raspberry Pi 400 breaks out all the usual connectors behind the keyboard – three USB ports (two USB 3.0, and one USB 2.0), two micro HDMI ports, microSD card, 40-pin GPIO header, and Ethernet. The only differences between this and a Raspberry Pi 4 are one missing USB 2.0 (which is taken by the keyboard), no audio jack (though HDMI audio is still available), and an additional Kensington lock connector should you need to secure the device to your desk. If you need analogue audio, you can add it using a USB sound dongle or an audio HAT.

We found the keyboard comfortable to type on. It's comparable with the laptop keyboard that this

Below ◆
The keyboard is comfortable to type on, and compact for easy storage and transport





reviewer uses day in day out, and you can get it in a range of different localisations, including UK, US, DE, ES, FR, and IT.

VALUE FOR MONEY

There are a few reasons to really like Raspberry Pi 400. The first is cost – at \$100 for the kit including mouse, 16GB microSD card, and *Beginner's Guide* book, it's one of the cheapest ways of getting a computer. The only thing you need to add is a monitor so, even if you don't already have one, you should end up with change from £200 after getting a complete setup.

For makers, there's the added advantage of having a tidy, solid computer for your desk built on the same hardware you use in projects. Want to fiddle with something? Just pop the microSD card out of your embedded Raspberry Pi board and put it in your 400, and you can make any changes you like. It's got the same 40-pin GPIO header as other Raspberry Pi boards, so you can use exactly the same HATs, PHATs, Bonnets, and other bits of extra hardware. The only slight disappointment here is that anything with a display on top will face away from the user rather than towards them. It's a bit of a shame that you can't have the glorious technicolour of a Unicorn HAT dazzling your eyes as you type, but unfortunately, the laws of geometry cannot be broken – not even by Raspberry Pi's engineering team. If this is a problem for your setup, you can use a GPIO extension cable to access the GPIO header more easily from the front of the machine. This reviewer has recently

been playing with a STEMMA QT / Qwiic-compatible HAT which works really well for making a desktop machine that you can quickly and easily plug additional hardware into.



Raspberry Pi 400 is a cost-effective, solid, and tidy option for a desktop Raspberry Pi computer



We suspect that a significant market for these computers will be institutions that want a set of cheap, customisable machines that 'just work'. Raspberry Pi 400 feels solid in our hands. While we haven't had it for long enough to be able to definitively say that it is robust enough to cope with rough handling in, say, a school, it's certainly tougher than other machines in a similar price range that we've used. The microSD card, as a storage medium, also works well here as it allows people to carry around their own data and operating system, while also making it easy to re-flash the card to get it back to an initial setup.

Obviously, a huge advantage of Raspberry Pi boards is that they're tiny and can be embedded in projects. However, in cases where you don't need this, Raspberry Pi 400 is a cost-effective, solid, and tidy option for a desktop Raspberry Pi computer. □

Above ♦
A tidy way of setting up your desk

VERDICT

Our favourite setup for using Raspberry Pi computers on the desktop.

10/10

NVIDIA Jetson Nano 2GB

Stripped-down silicon brains

NVIDIA  \$59 | developer.nvidia.com/embedded-computing

By Ben Everard

 @ben_everard



One problem with reviewing small computers is the huge range of things they can be used for. Should we evaluate its ability to be used as a desktop, as a robot's brain, or as a server? In many cases, these are all

common uses. With the NVIDIA Jetson, this isn't a problem. While it runs Linux and can be used for a wide range of purposes, really, it's a machine for one thing and one thing only: Artificial Intelligence. This is even printed on the box with the palindrome I AM AI.

Below  By embeddable computer standards, the Jetson Nano is quite big, but it's still small enough to fit in a robot

There are a few things that make it really suitable for this, and the most obvious is the 128-core Maxwell GPU. GPUs are traditionally used for creating flashy graphics, but it turns out that exactly the same processing power is useful for some other things, including running neural networks.

As well as this, there's a quad-core ARM CPU running at 1.4GHz. This new version comes with 2GB of RAM. While this is less than the 4GB on the previous version, the drop in RAM does come with a hefty drop in price – the Jetson Nano 2GB is just \$59 (the 4GB version is \$99). Another difference between this and the previous version is that there are now only three USB ports.

As well as processing power, there's plenty of connectivity, including a camera port (compatible with Raspberry Pi Camera Modules), and a 40-pin GPIO header. There is an Ethernet port, but no WiFi (though you can add a wireless dongle).

SOFTWARE STACK

The NVIDIA Jetson Nano 2GB SD card image boots into Ubuntu running the stripped-down LXDE desktop environment. This is fine for basic use and doesn't hog too much memory. However, machine learning can be a bit of a memory hog itself. If you boot up without a display attached, this desktop environment isn't started and you have more memory at your disposal.

There is a second problem with running the desktop environment – since most of the machine learning tutorials work on image recognition (though you can use many other sources of data and input

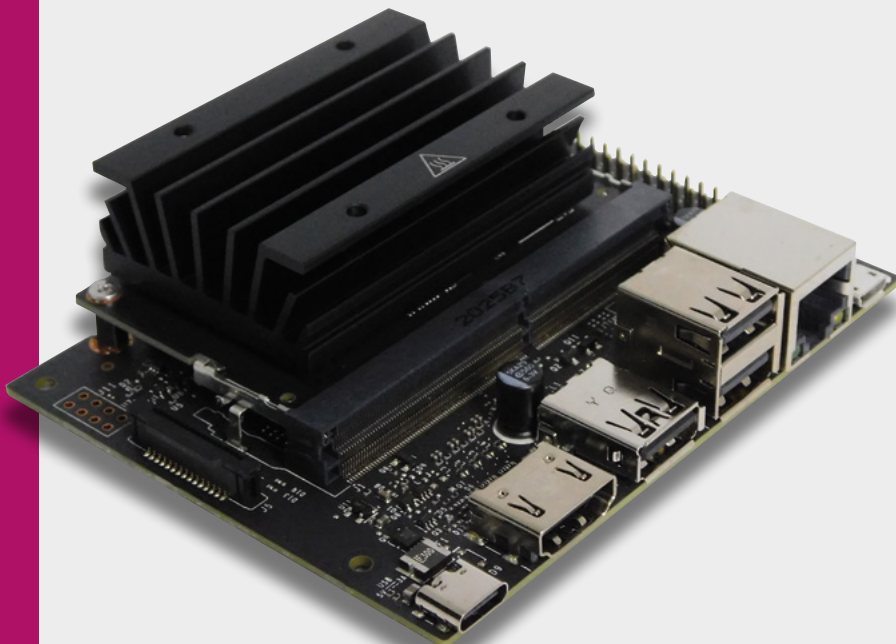

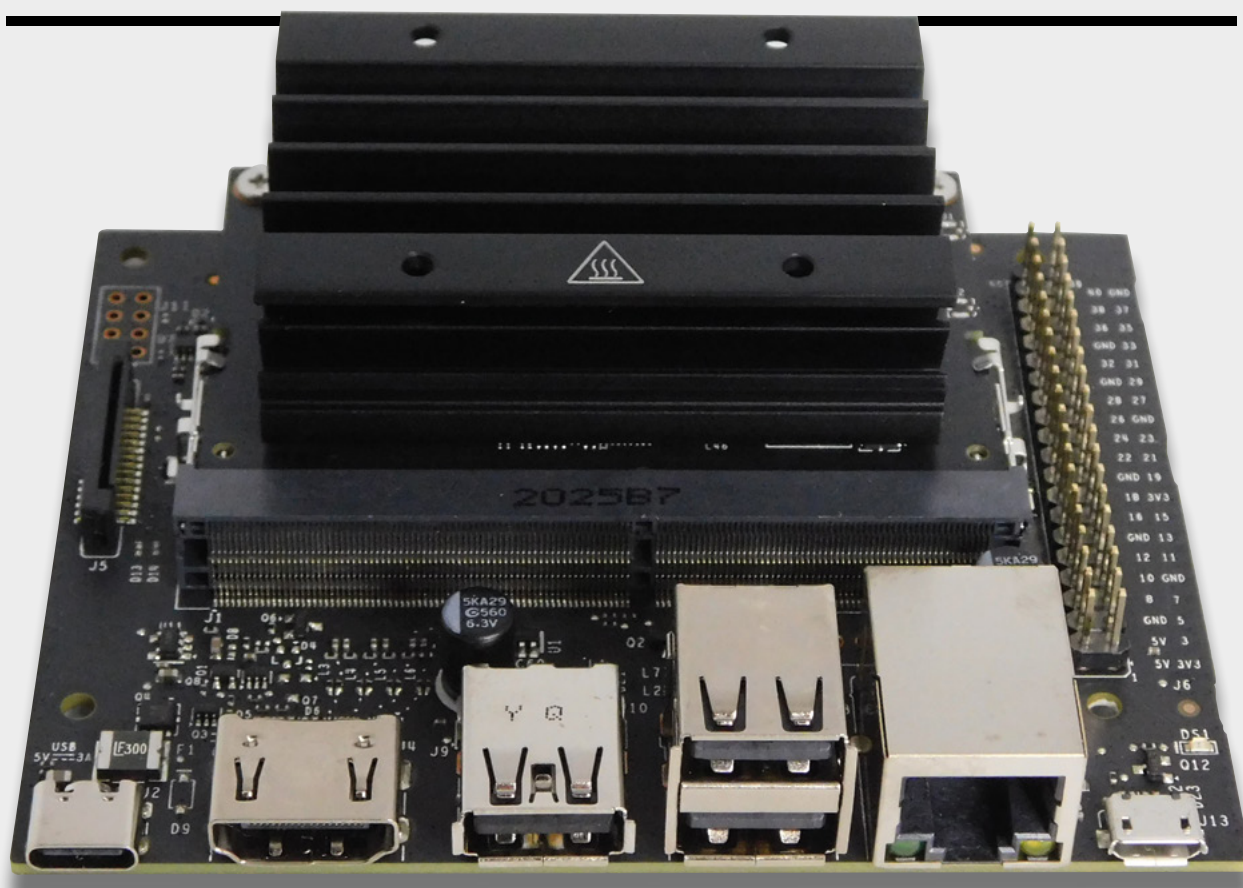

for your AI), if you use a USB webcam, keyboard, and mouse, then there's no space for a WiFi dongle.

Fortunately, the software has great support for working remotely. You can set up and run your Jetson Nano without needing a display at all, and much of the programming is done through the Jupyter web-based interface, so it really doesn't matter if you're working directly on the machine itself or another computer attached to the same network. Alternatively, you can use a camera connected to the ribbon connector – Raspberry Pi cameras are compatible, so you can use either the standard Camera Module or High Quality Camera to free up a USB port.

“ The hardware and software for the NVIDIA Jetson series really do make an excellent platform for learning about AI ”

Perhaps the stand out feature of the Jetson Nano 2GB isn't the hardware at all, but the learning system that NVIDIA has put together to help you get started with machine learning. There's a software bundle that downloads and installs everything you need to use some popular machine learning

toolchains, including TensorFlow and PyTorch. Alongside this, there's a series of free online courses to help you learn how to use this software.

Of course, it's not just about doing code running on the machine. The advantage of small computers is that you can embed them in robots, machines, and other projects. The 40-pin connector isn't necessarily compatible with Raspberry Pi HATs, but if you're looking to expand the functionality of a Jetson Nano, there is some hardware designed specifically for this board, particularly the range of JetBots (see hsmag.cc/e15q7e), which are wheeled robots designed to help you learn about machine vision with self-driving. Alternatively, you can build directly off the GPIO pins.

The hardware and software for the NVIDIA Jetson series really do make an excellent platform for learning about AI. It's easy to install and learn a vast range of industry-standard software, and the GPIOs mean that your machine can interact with the real world. Couple this with the learning resources to help you actually use the available machine learning software, and you have got a great platform for people getting started with AI. Whether you want to make a self-driving car, a vision-based object sorter, or any other camera-based AI.

The fact that they've been able to squeeze the price down to \$59 is a real achievement that makes it accessible to many more makers. □

Above ♦
The GPIO pins let you control external hardware such as motors, servos, and other ways of interacting with the world

VERDICT
A fantastic introduction to machine learning.

9/10

next month

issue

#38

ON SALE
10 DECEMBER

REMAKING MOVIES

ALSO

- 3D PRINTING
- MUSIC
- CIRCUITPYTHON
- LASERS
- AND MUCH MORE

DON'T MISS OUT

hsmag.cc/subscribe



Do you know HOW ROBOTS SEE?

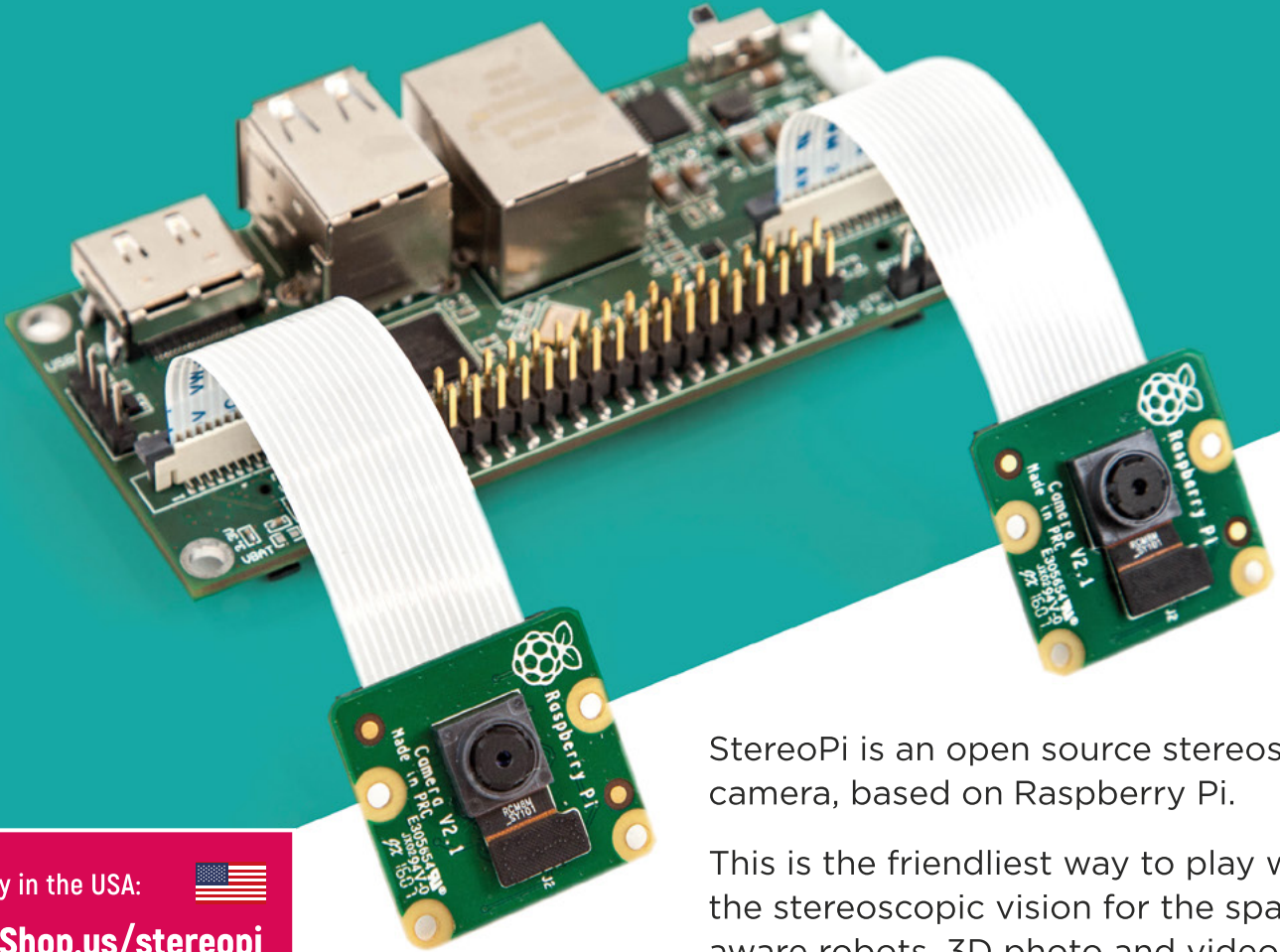

StereoPi is an open source stereoscopic camera, based on Raspberry Pi.

This is the friendliest way to play with the stereoscopic vision for the spatially aware robots, 3D photo and video!

Buy in the USA:



PiShop.us/stereopi

Buy in Canada:



BuyaPi.ca/stereopi



RASPBERRY PI INSIDE



STOCK RASPBIAN
SUPPORT



OPEN SOURCE



CROWDFUNDED
PROJECT

LinuxGizmos.com

"The StereoPi can capture, save, livestream, and process real-time stereoscopic video and images for robotics, AR/VR, computer vision, drone instrumentation, and panoramic video."

MickMake

"With it you can do things like, stream stereoscopic 3D video to YouTube, build real-time depth maps using OpenCV, create panoramics using Hugin and even a 3rd person view of real life. Cool."

Raspberry Pi Blog

"There are some excellent community efforts too, of which our current favourite is this nifty dual camera board."

Hackster News

"You can hook this up to YouTube, to Oculus Go, you can use it with OpenCV.. I cannot wait to start messing around with these because it's basically a dream come true."

