

MAKE | BUILD | HACK | CREATE

# HackSpace

TECHNOLOGY IN YOUR HANDS

hsmag.cc

December 2018

Issue #13



## BUILD A MAKER BUSINESS

Turn your hobby  
into your job

ALSO INSIDE

**ELECTRIC  
PLAYDOUGH**

Make circuits  
without wires

**HACKADAY  
PRIZE**

Discover the best  
in open hardware

**DIY  
ROBOT**

Build your first  
Arduino bot

**WILBUR  
PAN**

Japanese carpentry:  
tools, techniques,  
and trees



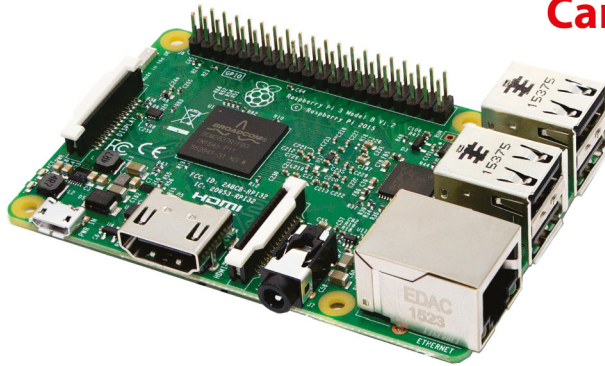
Dec. 2018  
Issue #13 £6



SCREWS BRUSHES TRANSISTORS PSU

## CanaKit Raspberry Pi 3 Ultimate Starter Kit

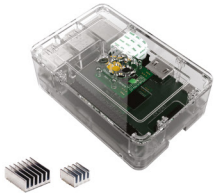
Model B | 1 GB RAM | 1.2 GHz | Quad-Core CPU



- > Learn to Code
- > Explore Computing
- > Get started with Electronics

### KIT INCLUDES RASPBERRY PI 3 AND ...

**PREMIUM CASE & HEAT SINKS**



**2.5A POWER ADAPTER**



**32 GB CLASS 10 MICROSD CARD**



PRE-LOADED WITH OPERATING SYSTEM

**USB MICROSD CARD READER**



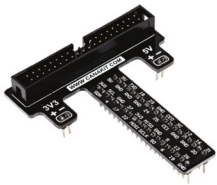
**PREMIUM HDMI CABLE**



**QUICK-START GUIDE**



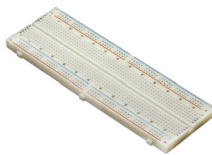
**GPIO TO BREADBOARD INTERFACE BOARD**



**RIBBON CABLE**



**FULL-SIZE BREADBOARD**



**JUMPERS**



MALE TO MALE & MALE TO FEMALE

**LEDs**



**RESISTORS & PUSH-BUTTONS**



Available for worldwide shipping at:

**WWW.CANAKIT.COM**

**Raspberry Pi Zero W**  
Available at CanaKit!







# Welcome to HackSpace magazine

With making, perhaps more than most activities, the border between hobby, lifestyle, and business can be blurred. For some people it blurs all the way to be a single thing where they spend their days making, but that's not the only way it can work. Many makers sell a small amount to help fund their making, or simply offload some bits they've accumulated.

Due to the magic of the internet, it's easier than ever before to sell things you've made – from online marketplaces

Many makers sell a small amount to help fund their making or **simply offload some bits they've accumulated**

that deal with the nitty-gritty of money transfer, to social media where you can court potential

customers, you can now create your shop without ever leaving your house.

Of course, if you're going to sell things, you need to make them first. For this, we have a further 120 pages of inspiration, so dive in and get making (then selling).

## BEN EVERARD

Editor [ben.everard@raspberrypi.org](mailto:ben.everard@raspberrypi.org)

Got a comment, question or thought about HackSpace magazine?

get in touch at [hsmag.cc/hello](http://hsmag.cc/hello)

## GET IN TOUCH

[hackspace@raspberrypi.org](mailto:hackspace@raspberrypi.org)

[facebook.com/hackspacemag](#)

[twitter.com/hackspacemag](#)

## ONLINE

[hsmag.cc](http://hsmag.cc)



## EDITORIAL

### Editor

Ben Everard

[ben.everard@raspberrypi.org](mailto:ben.everard@raspberrypi.org)

### Features Editor

Andrew Gregory

[andrew.gregory@raspberrypi.org](mailto:andrew.gregory@raspberrypi.org)

### Sub Editors

David Higgs, Nicola King

## DESIGN

### Critical Media

[criticalmedia.co.uk](http://criticalmedia.co.uk)

### Head of Design

Lee Allen

### Designers

Mike Kay, Harriet Knight

### Photography

Brian O'Halloran,

Fiacre Muller

## CONTRIBUTORS

Lucy Rogers, Andrew Huang, Mayank Sharma, Dave Astels, Andy Clark, Mari DeGrazia, Michael Jones, Les Pounder, Marc de Vinck, Gareth Halfacree, Daniel Hollands, Richard Smedley

## PUBLISHING

### Publishing Director

Russell Barnes

[russell@raspberrypi.org](mailto:russell@raspberrypi.org)

## DISTRIBUTION

Seymour Distribution Ltd

2 East Poultry Ave,

London EC1A 9PT

+44 (0)207 429 4000

## SUBSCRIPTIONS

Mann Enterprises Ltd,

Unit E, Brocks Business

Centre, CB9 8QP

[hsmag.cc/subscribe](http://hsmag.cc/subscribe)



This magazine is printed on paper sourced from sustainable forests. The printer operates an environmental management system which has been assessed as conforming to ISO 14001.

HackSpace magazine is published by Raspberry Pi (Trading) Ltd., Station Road, Cambridge, CB1 2JH. The publisher, editor, and contributors accept no responsibility in respect of any omissions or errors relating to goods, products or services referred to or advertised. Except where otherwise noted, content in this magazine is licensed under a Creative Commons Attribution-NonCommercial-ShareAlike 3.0 Unported (CC BY-NC-SA 3.0). ISSN: 2515-5148.

# Contents

118



06

## SPARK

- 06 Top Projects**  
The Musée d'Orsay of DIY projects
- 16 Objet 3d'art**  
Form meets function meets hot PLA
- 18 Upcycling**  
Delightful things made from rubbish
- 20 Meet the Maker: Electronic Cats**  
Why Mexico should share more open hardware
- 24 Columns**  
How to be a better maker? Make better things!
- 26 Letters**  
It looks like you lot like rockets...

29

## LENS

- 30 Build a Maker Business**  
Turn your passion into a career with our expert advice
- 44 Interview: Wilbur Pan**  
Revealing the mystical secrets of Japanese joinery
- 52 The Hackaday Prize: the Winners**  
The open hardware that's already changing lives
- 56 Improviser's Toolbox Toothbrushes**  
Dental hygiene has never been more hackable

## Cover Feature

**BUILD A  
MAKER  
BUSINESS**

**LIVE THE DREAM:**  
turn your making skills  
into a career

30

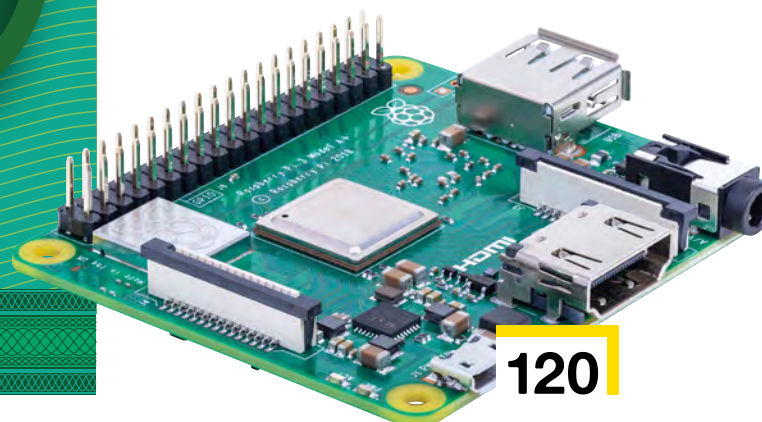
## Tutorial

### NFC cuff-links



76

Wear suave gadgets  
like a generic British spy



120



Direct from Shenzhen

Power supply



110

Control the cosmic power of electrons (but be careful!)



112

Interview

Wilbur Pan



44

Why maybe the Industrial Revolution wasn't such a great thing after all



52

61

FORGE

- 62 **SoM Electronics 101: Transistors**  
Understand the best thing since the wheel
- 68 **SoM Screwdrivers**  
Cross-head, Phillips, Pozidriv: we explain them all
- 70 **Tutorial Make a knife switch**  
Indulge your inner mad scientist with this sci-fi staple
- 76 **Tutorial NFC cuff-links**  
Be the best-dressed spy at the Christmas party
- 82 **Tutorial Conductive dough**  
Calculate resistances through squishy circuits
- 86 **Tutorial Scrolling door hanger**  
Tell humans to go away with blinkenlights
- 92 **Tutorial Router skills**  
Not used a router before? Try this storage tray build
- 96 **Tutorial Glove sampler**  
Play back sampled sound with a click of your fingers
- 104 **Tutorial Arduino robot**  
Create an autonomous rover from scratch

109

FIELD TEST

- 110 **Direct from Shenzhen Bench power supply**  
In which we try not to kill ourselves with unearthed voltages
- 112 **Best of Breed**  
Alternative conductors to bring variety to your electronics
- 118 **Can I Hack It?**  
Display custom festive greetings with an LED projector
- 120 **Review Raspberry Pi 3 Model A+**  
With great power comes a minuscule retail price (\$25)
- 122 **Review TS100 soldering iron**  
Control your soldering with this variable power tool
- 124 **Review Weekend Woodworker**  
We follow a beginner's course for amateur shed dwellers
- 126 **Review Graff SpeedCutter**  
Mercilessly shred anything woody that gets in your way
- 128 **Review MonkMakesDuino LCD**  
An Arduino clone built for your breadboard
- 129 **Book Review Harry Potter and the Methods of Rationality**  
YER A PHILOSOPHER, HARRY!

Some of the tools and techniques shown in HackSpace Magazine are dangerous unless used with skill, experience and appropriate personal protection equipment. While we attempt to guide the reader, ultimately you are responsible for your own safety and understanding the limits of yourself and your equipment. HackSpace Magazine is intended for an adult audience and some projects may be dangerous for children. Raspberry Pi (Trading) Ltd does not accept responsibility for any injuries, damage to equipment, or costs incurred from projects, tutorials or suggestions in HackSpace Magazine. Laws and regulations covering many of the topics in HackSpace Magazine are different between countries, and are always subject to change. You are responsible for understanding the requirements in your jurisdiction and ensuring that you comply with them. Some manufacturers place limits on the use of their hardware which some projects or suggestions in HackSpace Magazine may go beyond. It is your responsibility to understand the manufacturer's limits.

# Automated chess board

By Michael Guerero

[hsmag.cc/SuXYyT](https://hsmag.cc/SuXYyT)

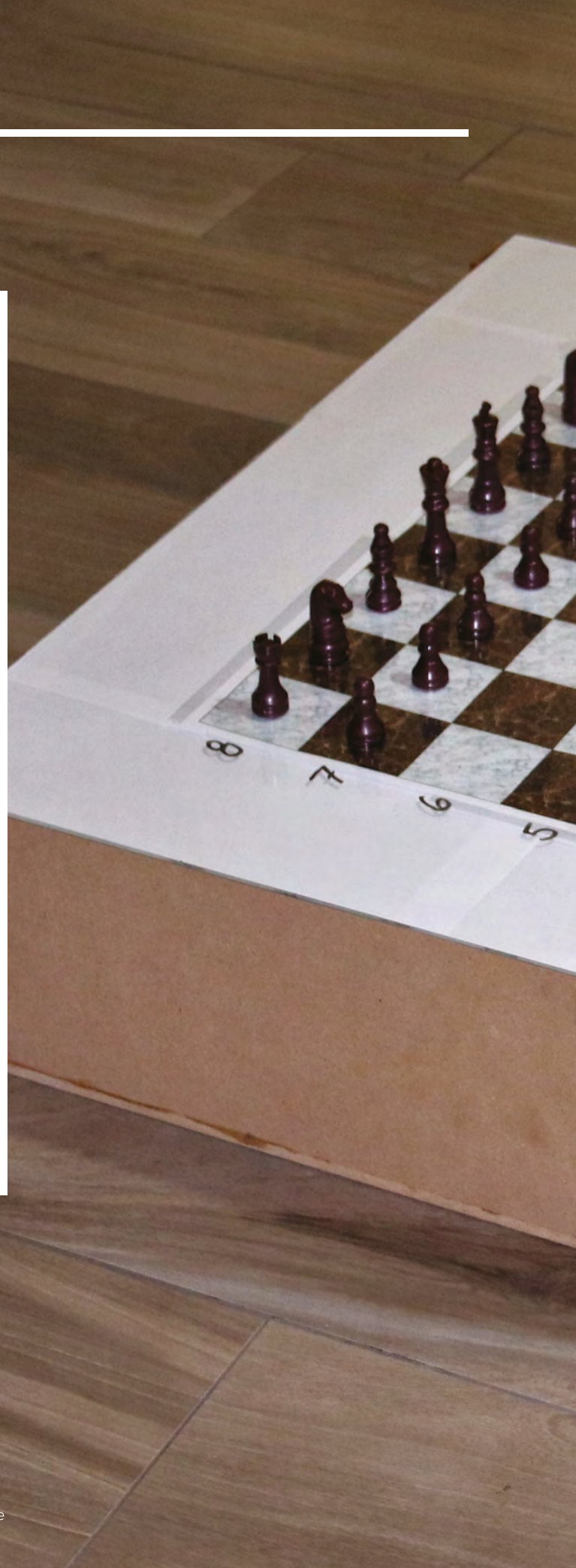
**M**y name is Michael Guerero and I'm a recent graduate from Cal Poly Pomona, with a bachelor's degree in mechanical engineering. I just recently started building my own projects to build up my portfolio and gain experience in prototyping.

In this project, I set out to replicate the Wizard's chess game from the *Harry Potter* series, because I liked the idea of using technology to emulate magic in the real world.

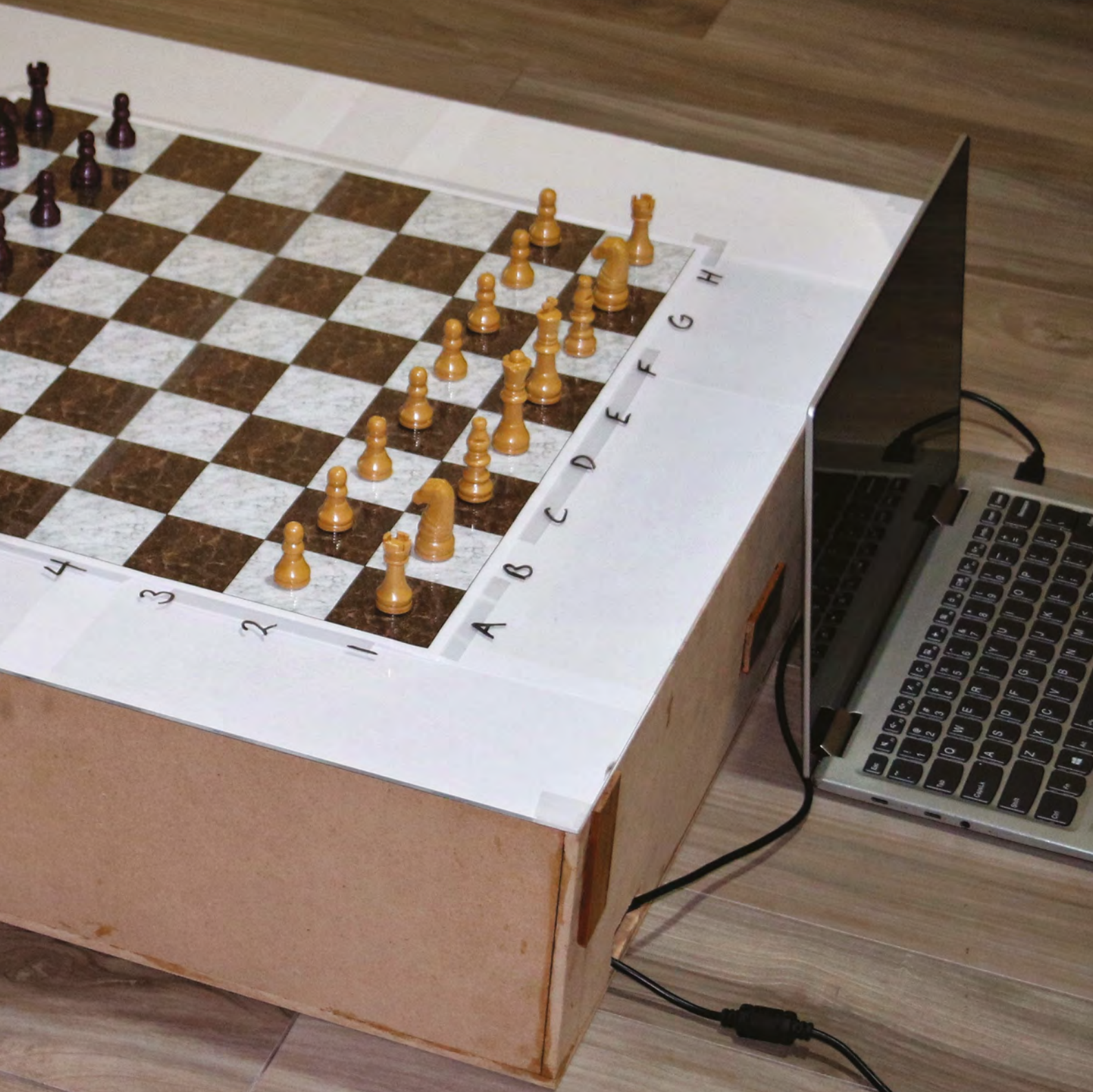
The box was made from quarter-inch MDF, with steel rods for the linear bearing blocks to slide across. I added various scrap pieces of wood to make supports, to hold the stepper motors and limit switches in the proper locations. A pair of timing belts are used to move the electromagnet along both axes. Each chess piece has a loose steel ball inside, which gives the magnet a way of attracting the plastic pieces.

The code starts by zeroing both stepper motors and returning the electromagnet to position A1 on the board. The serial monitor will prompt the first player to enter the square address of the piece to be moved, and the location for the piece to be moved to. The magnet moves to the first square, turns on the magnet, and then moves to the next specified square. When the piece is being moved, the magnet will initially offset to the corner and then move along the lines between squares, which allows pieces to be moved around each other without colliding (for example, this allows the knight to be moved without having to first move the pawns in front of it). □

**Right** □  
Active pieces move along the edges of the squares, so as not to disturb the rest of the board









# Battery-powered valve amp

By Thomas Hafemann

[hsmag.cc/AzRFMz](https://hsmag.cc/AzRFMz)

I started playing guitar in my teens, and saw DIY as an opportunity to build all the pedals that I could not afford at the time. I have built several mini amplifiers using sub-miniature tubes, but mostly they are still too loud to play in an apartment, and still require a lot of power just to heat up and power up the switched-mode power supply (SMPS) which multiplies the voltage, from 12V to 200V. I always wanted to build a battery-powered tube amplifier for the guitar, like some old radios, but wanted to use the current available LiPo batteries; much easier to recharge than the old 45V batteries. So, first I tested if the SMPS that I was currently using could work at lower input voltages. 3.7V in this case was not enough, so I used two batteries in series, and that worked up to 150V. The tubes I found while looking for battery tubes. There is an article about the 1J24b, stating that, with a much lower filament, it could deliver the same amplification as the DF96, making this tube the best gain/consumption tube available. For the power stage, I chose the 1J29b, from the same family of Russian tubes with lower filament currents.

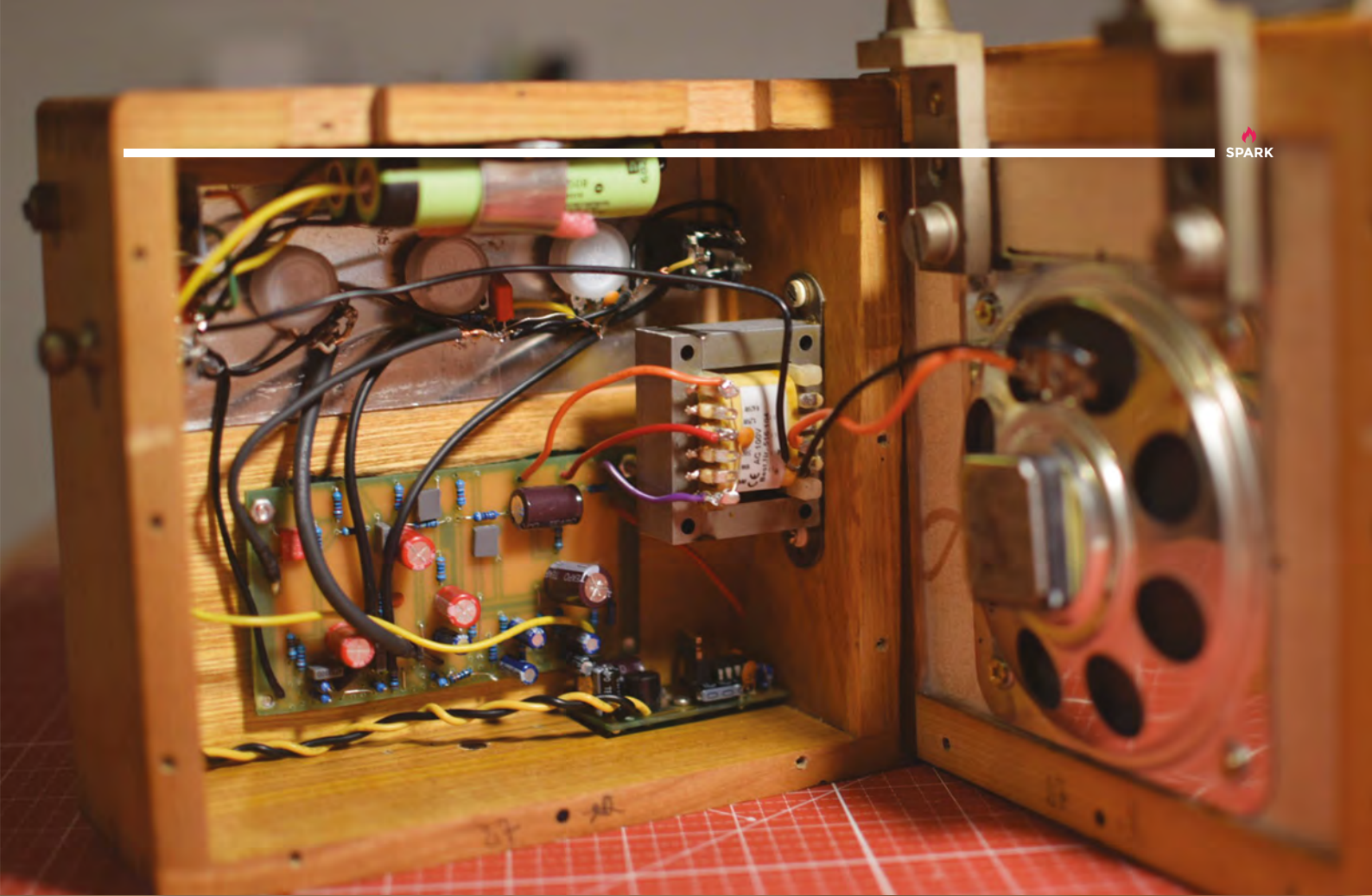
The amplifier is composed of two main stages: a paraphase phase inverter, and a push-pull output stage. I used a 100V line transformer as the output transformer, to keep the cost low, and to achieve the high primary impedance required by the output tubes. A proper transformer would be at least two times bigger, and would cost at least four times more than this one. □

**Right** □

The box for Thomas' amp comes from an old ammeter, and the four-inch speaker comes from a TV












# Electric typewriter

By NinjaTrappeur

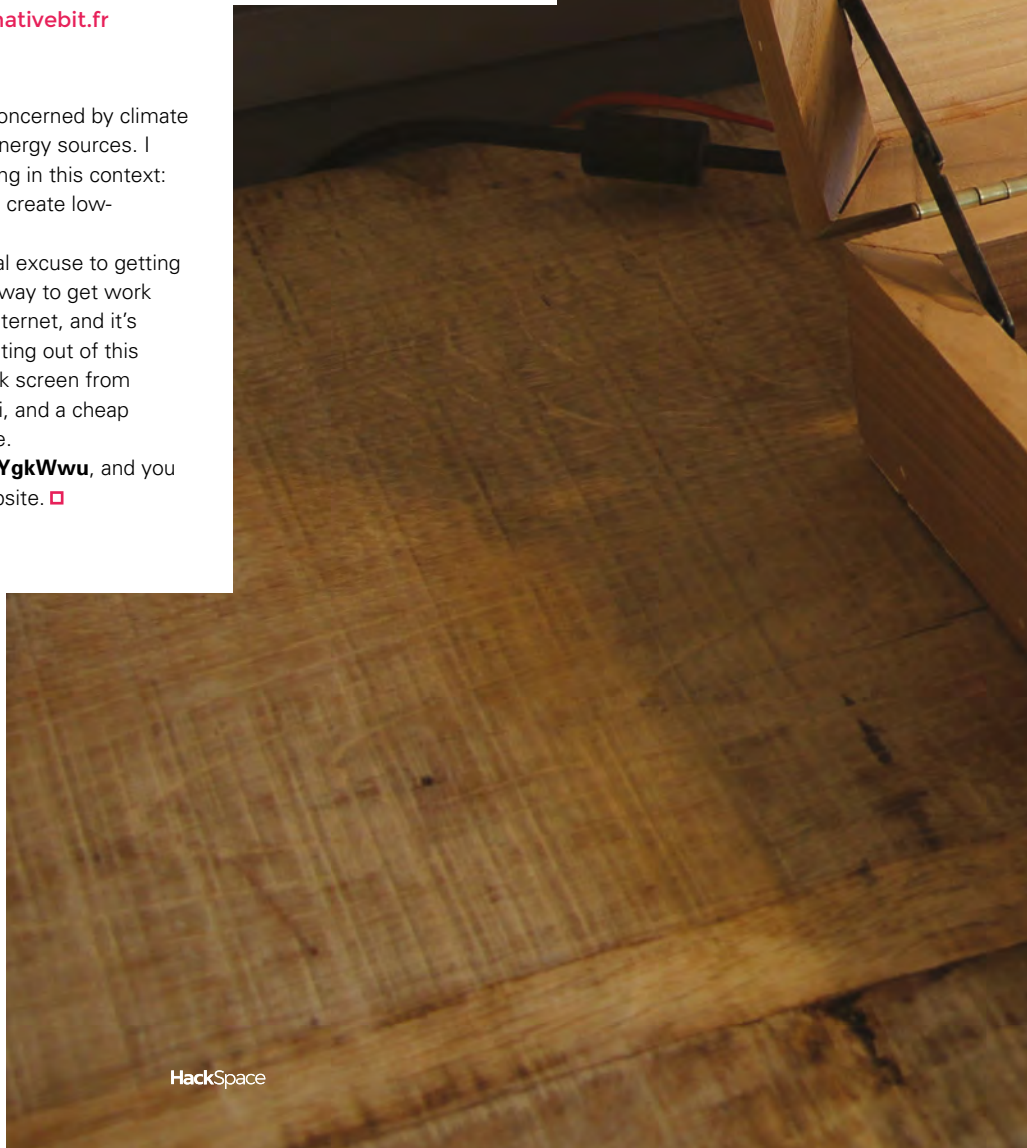
 [alternativebit.fr](http://alternativebit.fr)

I'm a French software engineer. I am concerned by climate change and its potential impact on our energy sources. I find the e-ink technology pretty interesting in this context: its bi-stable nature may be interesting to create low-energy computers.

This project was a pretty nice, practical excuse to getting started with e-ink technology. In addition, it's a way to get work done without the constant distractions of the internet, and it's surprisingly efficient – you'll get 20 hours of writing out of this machine. It was cheap to build, too: just an e-ink screen from Waveshare (based in Shenzhen), a Raspberry Pi, and a cheap keyboard, plus the cedar used to make the case.

I dive into the technical details at [hsmag.cc/YgkWwu](http://hsmag.cc/YgkWwu), and you can find more information about me on my website. 

**Right **  
The e-ink typewriter uses a standard Raspbian operating system





R:\*\* A digital typewriter based on a  
Berry Pi and a E-Ink screen. [The  
build instructions are available](TODO:  
ultimate writer picture](TODO: picture)

m easily distracted.  
is is both a blessing and a curse. On one  
nd, I can deal with a large amount of  
oredom without driving crazy. remaining  
rtifact from my school years and necessary  
skill to survive in our meeting-based modern  
corporate environment. On the other hand,  
completing a task requiring more than two  
minutes of my attention can turn into an  
escape game.

My behavior is far from being exceptional. As  
a matter of fact, some dodgy people are  
ultimate-writer.md





# Nybble

By Ronzhong Li

[hsmag.cc/cSTuwZ](http://hsmag.cc/cSTuwZ)

**W**e do like a good robot, but there are only so many wheeled robots that we can get excited about. Nybble is a programmable, open-source robot that reminds us of Boston Dynamics' Big Dog, but at a price (\$200) that makes it accessible to those of us without MIT-sized robotic budgets.

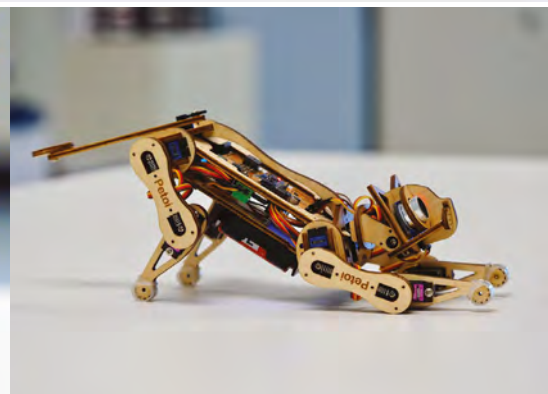
Nybble uses an Arduino-compatible microcontroller to store the commands used to stand, sit, lie down, and crawl like a kitten – the included Arduino sketch comes to 2000 lines of code. But, what really makes it exciting for us is the option to add a Raspberry Pi to give it some artificial intelligence, so it can learn from its environment and interact on the fly with what's around it. □



**Right** □

The use of a proximity sensor for the cat's eyes is either spooky or cute, depending on how you feel about cats











# Polyphonic modular synthesizer

By Matt Bradshaw

[@NerdOnTheWire](#)

**T**here is a very cool musical instrument called a 'modular synthesizer'. It requires you to use audio cables to connect analogue components, such as oscillators, amplifiers, and filters to create unique sounds. These instruments are sonically fascinating and endlessly customisable, but it's hard to make them play more than one note at a time.

This is why I designed a digital modular synthesizer. It still features replaceable modules, which can be connected to each other in the same way as a traditional modular synth, but all of the processing is done in software on a Teensy 3.6 microcontroller. Instead of an audio signal flowing down the cables, the Teensy simply detects which modules are connected to each other, and simulates the signal chain in software.

Because the audio is produced digitally in this way, it was fairly straightforward to make the synth play multiple notes simultaneously, by generating multiple virtual copies of each module in the system. □

**Left** □ Regular readers may remember Matt's guitar synth from [hsmag.cc/issue8](http://hsmag.cc/issue8)

# Objet 3d'art

3D-printed artwork to bring more beauty into your life



Head to [3dhubs.com/book](https://3dhubs.com/book) to check out the #1 3D printing book on Amazon

**T**his is the second iteration of Thingiverse user Brandon Blinkenberg's articulated butterfly – it now has stronger joints that are less likely to break when you put it together.

It's a straightforward print, with no supports or rafts required, and there's also an alternative version with a hole running through the wings, so that you can turn it into a necklace. ▣

[hsmag.cc/fYLyxU](https://hsmag.cc/fYLyxU)







**T**hingiverse contributor Igor Albuquerque has given us three sizes of his design to share, giving you no excuse not to have a well-lit work space. It's printed with an infill of 20%, and a resolution of 0.2 mm.

One thing you should be aware of is that, as the wires run along the outside rather than the inside of the lamp, it's potentially vulnerable to children looking for something to grab. Stay safe around electrons! □

➔ [hsmag.cc/UJldqL](https://hsmag.cc/UJldqL)

# Upcycling: electronic jewellery

Keep components out of the bin, and burnish your geek credentials with some unique shiny things

By Tanya Fish

[etsy.com/uk/shop/tanyafish](https://www.etsy.com/uk/shop/tanyafish)



I **work at a place that manufactures electronics, and so there were often sweepings left on the floor, or in the bottom of the pick-and-place machine.** They'd be uneconomical to replace on PCBs by hand, so I grabbed a tin of leftovers, and started making them into jewellery. I added NFC tags to some pendants to make interactive jewellery, but in most cases the beauty of the components speaks for itself. It's insane, the amount of electronic waste we generate, so with a root through a skip full of old printers, toasters, and the like, I took the PCBs and started snipping off the components to recover them.



**// It's insane, the amount of electronic waste we generate... I set the components in resin, and made them into something you can wear**

**//**

I set the salvaged components in artist-quality resin, and then made them into something you could wear to show off the components every day. Hair grips, pendants, key chains, it's all salvaged and happy to see another life.


I'm an educator, and an electronics enthusiast, who travels to spread the good word of circuits. Every piece that you buy enables me to carry on travelling, and spreading the word of how awesome electronics is. □

**Above** ♦ Like these shiny things? Buy them on Etsy!

**Right** ♦ Getting resin this shiny involves a lot of sanding and polishing. We think it's worth it





Below  If you're keen on electronics, you should recognise the electrolytic capacitors...





# Meet The Maker: Electronic Cats

Say hello to the educators behind 50 percent of Mexico's open hardware



**Open hardware is attractive for several reasons. It's often cheaper than closed-source hardware, and because the specifications are shared, it's easier to build on top of it.** It's also ideal for education,

as students can pull it apart, study the design, and learn how things really work.

Electronic Cats, a small team of hardware makers based in Mexico, have embraced openness for all of these reasons.

"We are Electronic Cats, we started up in Mexico. We do a lot of hardware, electronic boards, and embedded systems", says Eduardo Contreras.

"We make a product called CatSat, which is used to track satellites, and we've got one called MagSpooF, which is a hacking tool, for testing security on credit cards or debit cards. It reads the magnetic bands. Lots of hardware of different types.

"Now we have developed for one our friends who asked us 'Hey, would you do something like a Makey Makey but cheaper?'

"Makey Makeys are an educational programming interface, and they've been on the market for at least eight years. They've always been the same price and come with the same kit, so in Mexico it's really expensive. They cost \$30, but you need to pay taxes and the shipping cost, and import duties, and then the final cost is something like 45 percent more than the price.

"So we said, yes, we can do it. We chose ATSAM21, which is a really well-known chip right now. Arduino uses it, Adafruit uses it, everyone uses it, because it has loads of features. One of these is that you can use it as a peripheral touch controller.

"Instead of doing circuits like Makey Makey does, with resistive circuits, we do it with capacitive touch. Which is why we've got one plugged into a banana over here. You don't need to connect your ground potentials – you only need to touch the banana and the Meow Meow senses the change in capacitance.

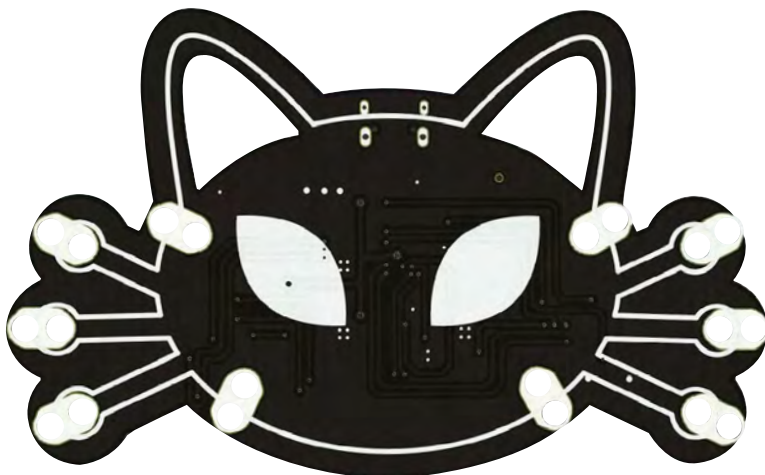
"So, we've improved the Makey Makey, and done it cheaper. We didn't think 'OK, that's all we want to do', we wanted to do another product. So, we spent a lot of time making it compatible with MakeCode.

"So we forked the MakeCode from Microsoft. Now you can go to our page and program your Meow Meow with blocks. If you want this pad to be another key and this pad to be an out for an LED, you can do it. So I press this, and I turn on an LED.


"Another good point for our project is that everything is open source. It's open-source hardware certified, and that makes us only the third open-source hardware project in Mexico. →

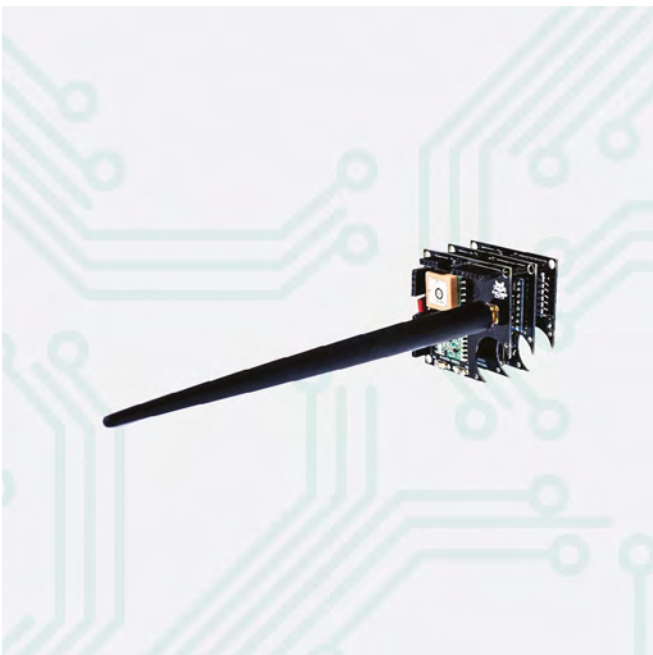
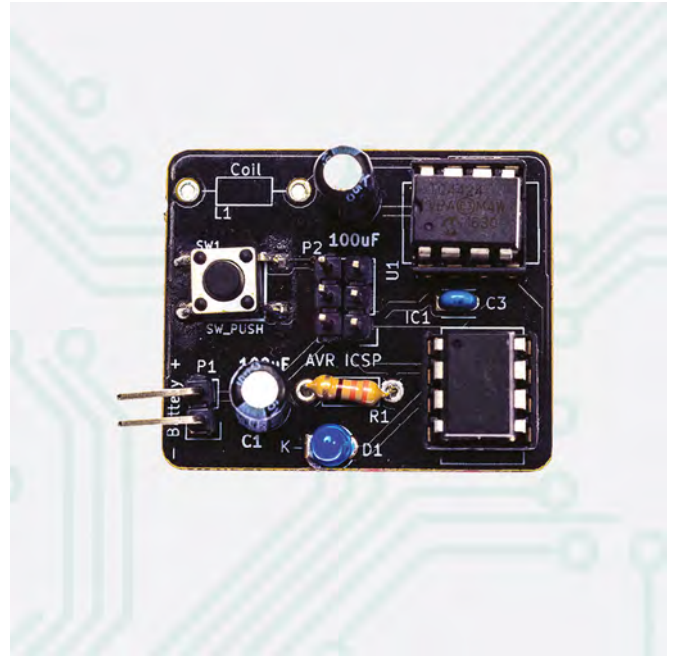
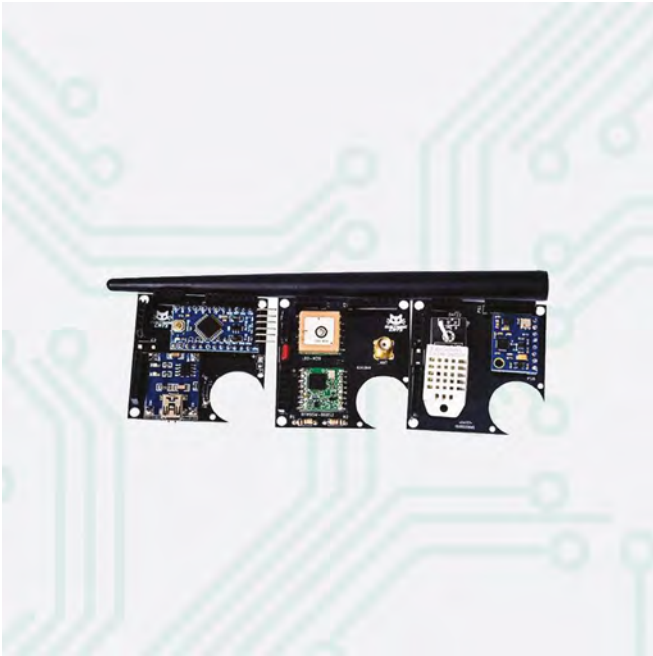
**Below**

The Meow Meow board uses capacitive touch, making it ideal for the classroom





**Below**  The CatSat 1 kit has everything you need to build a picosatellite





“There are only three projects registered in Mexico; well, by now there are four, and two of them are ours, so we account for 50 percent of the open-source hardware in Mexico.

“We’re trying to push people to send them to buy more open hardware. Everyone we speak to is very

**// In the maker community  
— everybody’s sharing, all the  
time, sharing knowledge,  
sharing designs... we want  
the same for Mexico //**

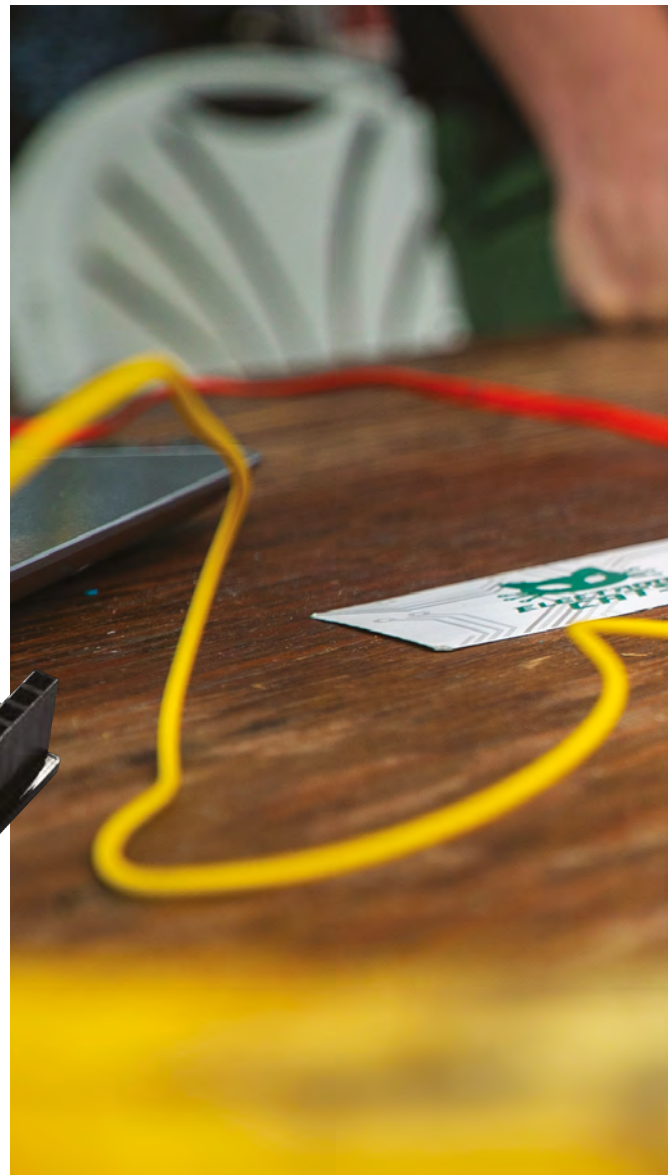
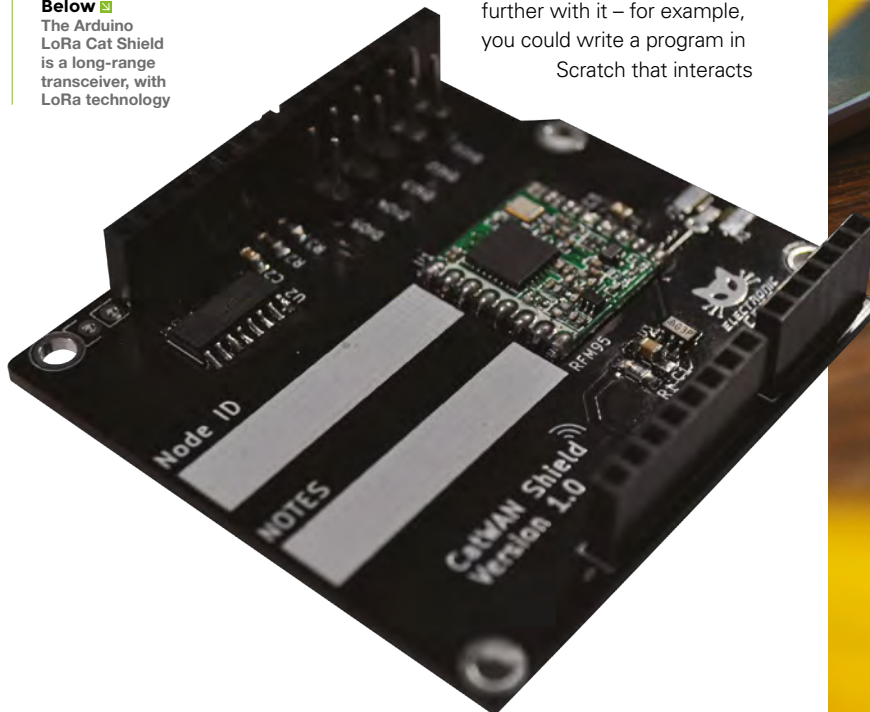
protective of their ideas, and they don’t want to share. But we want to encourage them to promote that culture in Mexico. Just like in the maker community, everybody’s sharing, all the time. Sharing knowledge, sharing designs, sharing projects, and we want the same for Mexico.

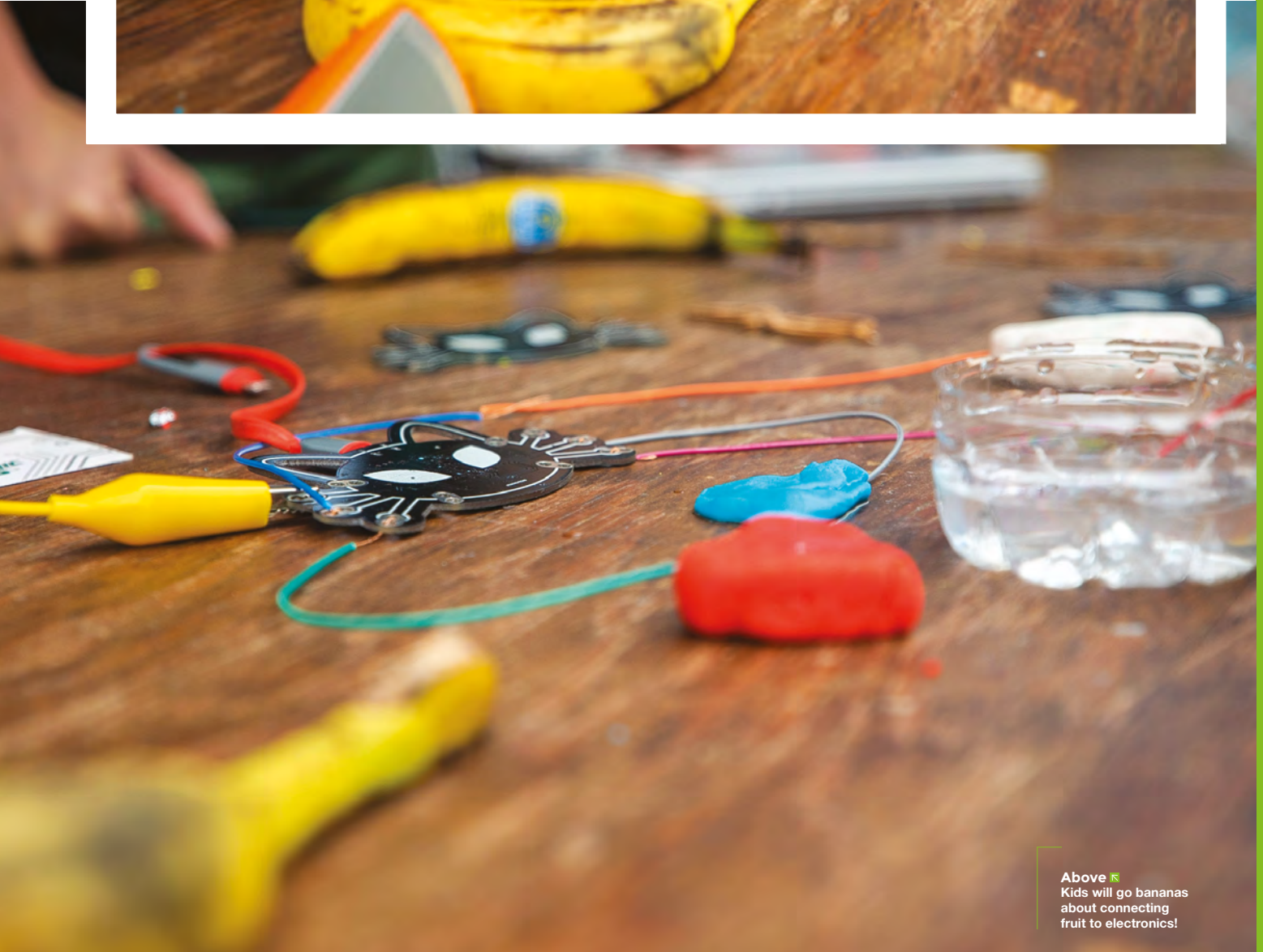
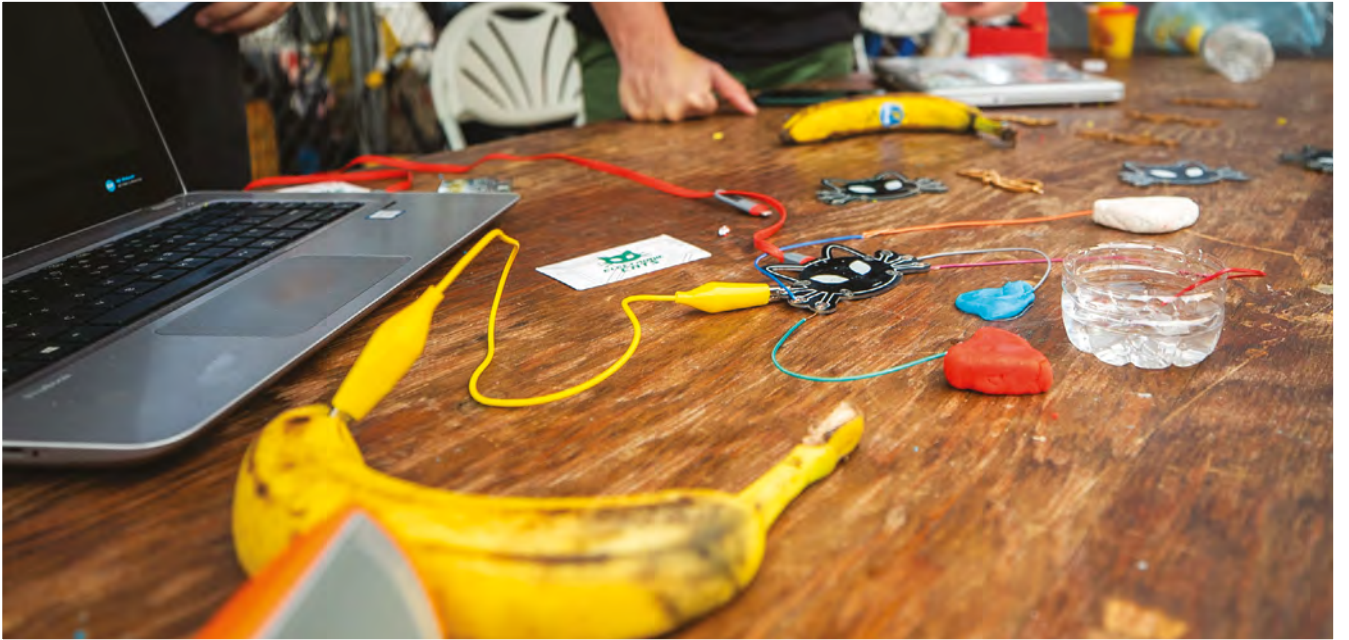
“That’s why we’re doing the Meow Meow. It’s cheaper, and it’s better for other applications, such as education. It started with touch interfaces, like the bananas, but you can go further with it – for example, you could write a program in Scratch that interacts

with your keyboard. You can add Scratch, LEDs, transistors, and go from electronics to programming in JavaScript, Python...

“We think our final customer will be schools, but it’s for anybody. Everyone loves cats. We’re focusing on STEM education and schools, but we really think that it’s for everyone. The idea is that kids start playing with the Meow Meow to introduce some disciplines in science, like programming or electronics. In Mexican secondary schools, teenagers from 12 to 15, or up to college age, will start to play with the Meow Meow and make incredible things.” □

**Below** □  
The Arduino LoRa Cat Shield is a long-range transceiver, with LoRa technology





Above 🍌  
Kids will go bananas  
about connecting  
fruit to electronics!



# Wise words

Turning a hack into a product



Lucy Rogers

[@DrLucyRogers](#)

Lucy is a maker, an engineer, and a problem-solver. She is adept at bringing ideas to life. She is one of the cheerleaders for the maker industry, and is Maker-in-Chief for the Guild of Makers: [guildofmakers.org](http://guildofmakers.org)

**“W** hat simple tip would you give to a maker to turn their ‘thing’ from a ‘hobbyist hack’ to a ‘beautiful / saleable product’?”

I recently asked this question when I hosted the Guild of Makers’ #MakersHour on Twitter (every Wednesday, 8pm UK time). I really wasn’t expecting quite so many amazing responses.

@Maker\_of\_Things: “Add confidence. Being confident about your abilities, being confident about your ‘thing’, being confident that your ‘thing’ does what it should, is ‘sorted and right’, and has a decent lifespan. Being confident over your pricing, being confident telling people.”

@ste5eu: “Make it easily repeatable or really expensive – that seems to work for others.”

@fowkc: “Know when to outsource.”

Many tweets could be grouped together. There was a lot of talk about boxes...

@boeerb: “Put it in a nice box.”

@Ka8l: “Perfect 3D printing using Autodesk Fusion 360, and design beautiful casing and outsides for your electronic spaghetti!”

## Finishing (and starting)

@ExtElec: “Finish it off. It’s the small things. Colours, rounded corners, make it easy to use.”

@baileysteinfaadt: “Attention to detail. Even on the parts you find boring.”

@semachthemonkey: “Make it, put it up for sale, sell it, listen to feedback, refine it. (Also, try to make it fit within a ‘large letter’ size package to reduce postage costs).”

**“Finish it off. It’s the small things. Colours, rounded corners, make it easy to use”**

@NathanBurley25: “Get on with it! We all tend to think we’ll do it eventually, and that it’s not quite there yet, but I find nine times out of ten it’s already good enough for people to buy it. The other thing would be set a deadline and stick to it!”

## Documentation

@concreted0g: “I found giving good examples of how it could be used and documentation helps.”

@monkeysailor: “For anything technical (physical or virtual): documentation and examples. Don’t be afraid to do an extra step if it improves clarity. For anything

artistic: Kill your darlings – excise what doesn’t fit well, without mercy.”

## Simplification

@M\_Fkill: “For any electronics products, it has to be PCBs. They make it

possible to scale and simplify building and add reliability.”

@Workshopshed: “Cabling and connectors are very important. Also simplify as much as possible.”

## Marketing

@dr\_monkeyface: “Without banging on about making sure it doesn’t explode and/or do something dangerous, make them quick to turn around and market yourself. Nobody will buy your thing if they don’t know it exists.”

@strangeurios: “Hire a museum to exhibit the stuff. I did.”

@MissSpencerDT: “Take good photos, and don’t be afraid to brag – chances are, it’s already beautiful :)”

The final word, though, came from @WokStation...

“Hide the glue”. □

# Master input/output

Tips on using the Raspberry Pi's GPIO Block



**Bunnie Huang**

🐦 @bunniestudios

Andrew 'Bunnie' Huang is a hacker by night, entrepreneur by day, and writer by procrastination. He's a co-founder of Chibitronics, troublemaker-at-large for the MIT Media Lab, and a mentor for HAX in Shenzhen.

General purpose input/output pins – GPIOs – are the bread and butter of embedded controllers. They are what allow users to blink LEDs or emulate a wide range of oddball interfaces. Single-chip controllers, like the ATmega, STM32, or Kinetis, offer bare-metal control over GPIO blocks, but lack a native connection to the internet. Smartphones, laptops, and desktops feature excellent connectivity to the internet, but lack user-exposed GPIO blocks. Thus, the Raspberry Pi occupies a unique niche in the IoT spectrum, offering a robust suite of internet connectivity protocol options, while offering bare-metal access to its native BCM2835 GPIO block.

Every GPIO block has its quirks, and the BCM2835 is no exception. The manual originally published by Broadcom redacts a set of key configuration bits within the GPIO block, namely those that allow users to configure parameters such as slew rate and drive strength.

Slew rate and drive strength are related to how fast and how hard a GPIO can switch its output. This can have a profound impact on signal integrity; if you're driving long fly-wires with a GPIO, you want to switch the lines as gently as possible, whereas if you've built a plug-in 'HAT' PCB for the Pi, you can optimise for performance, and drive the GPIOs quite fast and hard.

Fortunately, a Google search for 'BCM2835 slew rate' will land you on an extract of a full manual page, which divulges the key bits needed to adjust these parameters.

Another subtlety of the GPIO block is that it runs much slower than the CPU. The GPIO block logic maxes out around 125MHz, but the CPU core on the latest Raspberry Pis zooms along at 1.4GHz. To bridge this gap, a synchronisation mechanism is necessary.

In practice, measurements demonstrate that successive GPIO accesses seem to get bunched together in a shallow queue. Thus, a high-speed clock waveform, emulated using a series of GPIO writes interleaved equally with delays, can turn into a series

of glitches, as the GPIO events going through the queue lose temporal correlation with the code running on the CPU. Various projects have been affected by this situation, including OpenOCD, limiting performance or reliability. Inserting dummy writes or reads can flush the queue and help guarantee the I/O operations arrive at roughly the expected interval, thus restoring correct functionality to the code.

While the GPIO functionality of the Raspberry Pi is a great resource, it helps to be aware of its quirks when pushing to optimise its behaviour for your application. □

**Every GPIO block has its quirks, and the BCM2835 is no exception**



# Letters

## ATTENTION ALL MAKERS!

If you have something you'd like to get off your chest (or even throw a word of praise in our direction) let us know at [hsmag.cc/hello](http://hsmag.cc/hello)

### COPPER PIPE LIGHTING

What's the essence of hacking? Taking something that was intended for purpose A and using it for purpose B, in my view. Keep up the good work with the projects – I'll be having a go at making something useful out of copper piping myself over the Christmas break.

**Ian**  
Stroud

**Ben says:** Aww, shucks. Have fun, remember to make sure anything you do with mains electricity is safe.



### SPAAAAACE!

I always wanted to be an astronaut when I was a kid, but life and short-sightedness got in the way. Thanks for the pages on rocketry – I think I'll give my 10-year-old self a gift and get a little starter kit.

**Mary**  
Stafford

**Ben says:** Rocketry is a massive rabbit hole; you can spend ages learning about and tweaking all the parameters, or you can just get started. I recommend you do both!

### WHAT DO YOU WANT?

I'd like to see more step-by-step tutorials in HackSpace. Sometimes you just get a picture and no idea of how it's made, or the words will be about something, rather than how you can make to yourself. Otherwise, keep it up.

**Ravi**  
London

**Ben says:** thanks to everyone who took part in our reader survey. One thing that stood out is that variety is good, so we're going to keep mixing things up; you can also expect to see some more step-by-step tutorials making an appearance.

# GET YOUR FIRST 3 ISSUES FROM £5

on a quarterly subscription



Use the code **HS-SAVE** at the checkout

Visit: [hsmag.cc/345](http://hsmag.cc/345)



# The Building Blocks for Your Next Innovation

Hardware

Interconnects

Wireless & RF

Power

Industrial Automation

Semiconductors

Electromechanical

IoT

**Digi-Key**<sup>®</sup>  
ELECTRONICS

Sensors

Passives

Dev Boards

0800 587 0991

**DIGIKEY.CO.UK**

**FREE SHIPPING**  
ON ORDERS OVER  
£33 OR \$50 USD\*



7.4 MILLION+ PRODUCTS ONLINE | 750+ INDUSTRY-LEADING SUPPLIERS | 100% FRANCHISED DISTRIBUTOR

\*A shipping charge of £12.00 will be billed on all orders of less than £33.00. A shipping charge of \$18.00 USD will be billed on all orders of less than \$50.00 USD. All orders are shipped via UPS, Federal Express, or DHL for delivery within 1-3 days (dependent on final destination). No handling fees. All prices are in British pound sterling or United States dollar. Digi-Key is a franchised distributor for all supplier partners. New products added daily. Digi-Key and Digi-Key Electronics are registered trademarks of Digi-Key Electronics in the U.S. and other countries. © 2018 Digi-Key Electronics, 701 Brooks Ave. South, Thief River Falls, MN 56701, USA

ecia  
MEMBER



# LENS

HACK | MAKE | BUILD | CREATE

Uncover the technology that's powering the future

PG  
44



## INTERVIEW: WILBUR PAN

The tools, trees, and techniques of Japanese joinery (and only a single mention of Zen)

PG  
52

## HACKADAY PRIZE: THE WINNERS

Say hello to (and be inspired by) the open hardware that's going to improve the world

PG  
56

## IMPROVISER'S TOOLKIT: TOOTHBRUSHES

Cheap, malleable, disposable: and perfect for making unique things out of

PG  
30

## BUILD A MAKER BUSINESS

Turn your hobby into a career  
with our expert insights





# BUILD A MAKER BUSINESS

Turn your hobby into  
your job

**M**aker businesses come in all shapes and sizes. Some makers harbour dreams of quitting their jobs and decamping to a workshop to busy themselves on projects all day, while others are perfectly happy in their day job, but would like their hobby to bring in a little income to get more kit for better makes. For other makers, the goal of a business isn't to bring in money (though it might have that side effect). Some people simply like making things and don't want to clutter up their house, while others have found a way of solving an annoying problem and want to share this solution with the world.

Your goals might be one of these or they might be completely different, and that's fine. As soon as you start bringing in money from making, you are a professional maker – and you're running a maker business.

Starting a maker business is just a case of making something and finding a place to sell it (or other way of getting income) – these days there are lots of places to put your wares up for sale. The hard part

is building this business up to the point where it's performing the way you want it to. There's no correct definition of success for a maker business: it's all about deciding what you want to achieve and working towards that goal.

Unfortunately, there's no blueprint for how to do this. The very nature of the maker businesses is that they're unique. Your business won't be the same as another maker's because your makes aren't the

### Starting a maker business is just a case of making something and finding a place to sell it

same as another maker's. Your objects have some of your personality, and so will your business. However, all businesses need to bring in money, attract customers, and most have to put on a good internet storefront, so let's take a look at what it takes to do this. →



**Ben Everard**

[@ben\\_everard](#)

Ben loves cutting stuff, any stuff. There's no longer a shelf to store these tools on (it's now two shelves), and the door's in danger.





# Making Money

What will people pay you for?



**Above** ♦ Alec Steele's YouTube channel makes income through normal YouTube advertising, video sponsors, and merchandise sales

**P**erhaps the most basic question for any business is, where does the money come from? There are two fundamentally different answers to this for professional makers: you can sell the things you make, or you can get

paid by people to entertain and inform them, through the medium of making.

If you're going to sell the things you make, you'll need a way of selling your products. This can be through your own shop or website, but it can be easier to build up a customer base by using a site such as Etsy (for general handmade items), and Tindie (for electronics).

Of course, you don't have to sell your products online. There are plenty of places to sell your products in the real world, including local craft shops and markets. These can work particularly well if your product is (or can be) linked to the local area.

Rather than selling products you have already made, many makers work to commission, to build something a customer wants at an agreed price. This can be for individual customers or organisations (for example, some publicity firms commission makers to build things to help show off their products). This has the benefit that you know that what you're making will sell, but it can take some time to build up an audience of people looking to commission you.

## INFORMATION OVERLOAD

As well as getting paid for things you make, there are plenty of makers being paid to inform, entertain,



educate, and otherwise communicate about making. A few examples here are:

**Advertising:** Most makers who are earning money through advertising are doing it on YouTube. In order to be eligible to earn money on a YouTube channel, you have to have at least 1000 followers and 4000 hours of views in the last year. On YouTube (as on most other sources of advertising online), you can be paid in cost per mille (CPM) or cost per click (CPC) – most of the time, you’ll get a combination of both. CPM is a fixed price per thousand views, while CPC is a fixed amount per click. There’s no way of knowing how much you’ll make in advertising on YouTube; it’ll come down to what videos you’re making, and who your audience are.

**Sponsorship:** A secondary source of income for people making content is sponsorship. This can come in a number of forms, but typically for makers, it’s where a company pays you to use their products in their videos. For it to work well, it needs a good relationship between the maker and the sponsor, as different companies will want different amounts of control over the content.

A similar but slightly different form of sponsorship is through affiliate links. This is where you put a link to buy a product in your video (or webpage), and every time someone uses that link and buys something, you get a proportion of the sale.

You don’t have to get sponsored by corporations. Increasingly, content creators are turning to their viewership to help them make great content. Platforms such as Patreon, Sether, Flattr, and others

**Below** ♦ Rachel ‘Konichiwakitty’ Wong sells kits and runs workshops, to get young people interested in making and crafting



**Above** ♦ Noisy Toys combine making with performances in their job as science communicators

help viewers easily pay makers to keep making videos, podcasts, blog posts, or other media.

So far, all of the ways that we’ve looked at have been as a maker taking control of the whole procedure of processing their content – even if it’s on someone else’s platform – but another

## There are plenty of makers being paid to inform, entertain, educate, and otherwise communicate about making

option is to create content for another organisation. In these cases, the creator typically creates the content, while the company takes care of packaging it, and distributing it to customers. This is exactly what people writing for this magazine do. This is a good option for people who don’t want to focus on other aspects of selling content to the public – such as building a brand.

There isn’t a single way of being a professional maker, and the future will undoubtedly bring even more options. There is no definitive best option: it completely depends on what you like making, the skills you have, and the channels you have to build a market. There’s also no reason you have to stick with only a single channel, or even to stick with the income-generating methods you started with. If you understand your skills and your audience, experimenting with income models can be the best way to find the one that works for you. →





# Setting up shop

Putting your products in front of customers

## W

**hile we looked at many ways to be a professional maker, by far the most popular is to sell things you've made, so let's take a closer look at this.**

Tindie – the electronics maker marketplace – has dug into its data to find out what makes a seller successful on its site. We don't have access to data from other selling platforms, but we'd expect them to follow the same rough trends.

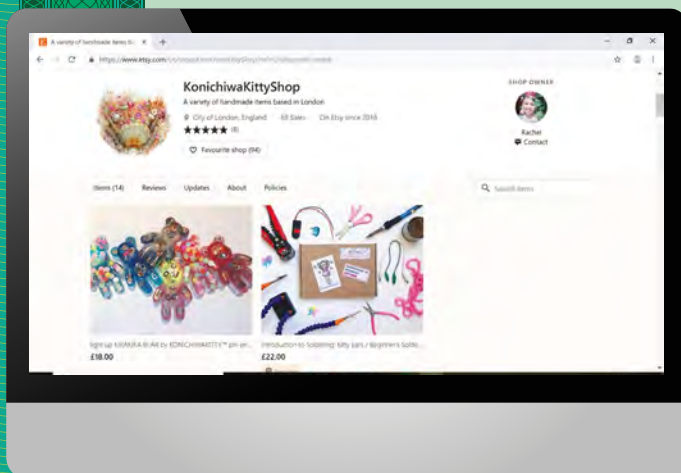
First up, the overall picture is that about half of all products have been ordered at least once, and the average (median) number of sales per product is four.

Now, selling a product four times is unlikely to be enough to make you a living as a maker, but this is fine. That number is the average, and many people selling products aren't doing it as their full-time job. This points us to the first thing about selling things – be realistic with what you want to do and hope to achieve. It's very unlikely that you'll just be able to pop a product on a shop and suddenly make a living. The chances are, you'll have to build up your business

## It's very unlikely that you'll just be able to pop a product on a shop and suddenly make a living

slowly. Some Tindie products have been sold over 3000 times (and this is per product, not per store), and many products are sold in other places, such as maker meetups, as well as through Tindie. This shows that there is scope to gain an income through selling, but it's unlikely to happen by default.

Let's first take a look at what it takes to lift yourself into the 50% of products that do sell at least one. The number of products within your store has a huge



**Left** Rachel Wong's Etsy shop shows how effective good photography is at capturing attention

impact on success – not just overall, but for each product. The probability of a store with just one item having a sale is 20%, but increases to 52% for those with 35 items, then starts to drop off again with more items. However, there's no need to rush to design your first 35 items, as most of the growth is in the first few. Items in stores with five items have about a 40% chance of having sold.

Once you've got the number of items sorted, the second most important thing is adding options. Obviously this won't be relevant to all products, but if you can, options provide a huge boost to sales, as adding just one option makes products 17% more likely to sell. Customers like to have some input into the things they buy as this is a key part of buying from a maker.

Once you've got these products sorted, it's important to get the pages working properly. Adding documentation boosts the probability of selling by 4%. Six or more bright, well-lit images is another significant indicator of success. The description should be around 250 words and well laid out (use paragraphs, tables, bullet points, and other formatting to avoid a wall of text). A punchy title of no more than ten words should complete your page.

This is all driven by statistics and, while it's good general advice, you obviously know your product best, and not all of these points will be relevant to every product.

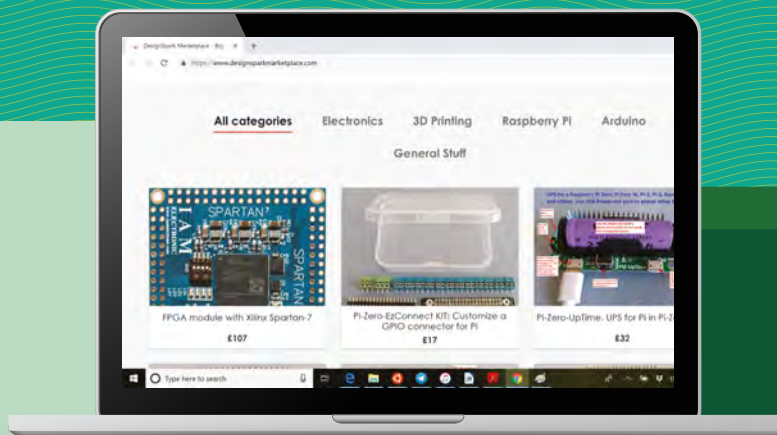
## THE ROAD AHEAD

When you start out as a professional maker, you're setting up a business, and businesses can take a long time to get established. Perhaps the most important factor in success is staying on track while you're

## Ongoing homework

Here, we've presented a whistle-stop guide to what it takes to set up a maker shop, but there are loads of further resources out there to help you on your journey – Etsy has a fantastic Seller Handbook ([etsy.com/uk/seller-handbook](https://www.etsy.com/uk/seller-handbook)).

It's a great place to learn more about the finer points of running a maker shop and is packed full of advice on even the most arcane topics. Whichever platform you sell on, you're bound to find useful information to help you grow your business. Just remember, you don't need to read it all before starting. Get up and running first, then you can improve as you learn more about running a maker business.



building your way up. Setting realistic goals is the best way to do this.

Of course, it's all well and good to say 'set realistic goals', but what are realistic goals?

Sell your first item. Let's not beat around the bush. If you're going to go pro, you need to sell something, and the first thing you sell is always going to be the hardest. And, from this point on, whatever else happens, you are a professional maker. To hit this, you'll need to set up at least one sales channel, make at least one thing to a professional standard, and attract at least one customer.

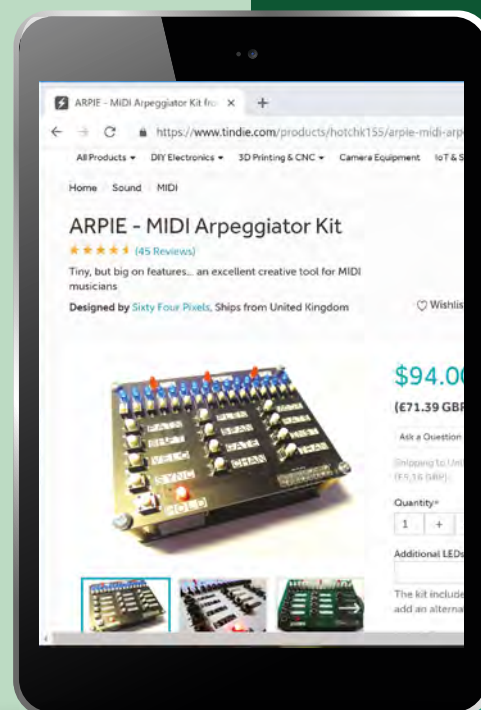
What comes next? Perhaps one sale per month; perhaps getting five different items on your store; perhaps you want to focus some of your goals on building a community around your product, as well as selling it. Perhaps it makes sense for you to look at income, rather than number of products sold.

Exactly what your goals are doesn't matter, as long as they present an achievable progression towards your end goal (whatever that is).

One of the best ways of learning is by doing. No shop is perfect when it's created, and an imperfect shop is far better than no shop. As you add new products and generate sales, you'll learn what works for you and your customers. Books and other sellers can provide guidance, but it's only when you put this into practice that you'll really start to learn what it takes to run a maker shop. ->

**Above** ♦ DesignSpark's marketplace, launched this year, is the newest contender as a place to sell your makes online

**Below** ♦ You can find a great example of a Tindie shop at [hsmag.cc/vHJcGC](https://hsmag.cc/vHJcGC) – punchy title, clear photography, a good description, and some options





# Social Media

Time to cultivate a following



**I**f you're running a maker business, you're going to need customers. Unfortunately, you're unlikely to find that they come to you. At least at first, you'll probably have to go out and reach potential buyers. Love it or hate it, social media is one of the best ways to get people to see your work. However, building an audience requires more than just an account – you need to attract followers and keep them engaged with your posts. We asked Tindie's Jasmine Brackett for her best tips on how to use social media as a maker selling on the internet. Here's her advice...

Perhaps the hardest part for many people on social media is knowing what to post about. A

really good option is to ask questions, or answer questions from others – get involved where you read things that interest you. If you're a maker, there's a pretty good chance that a lot of your followers are makers as well. If you're stuck on a problem, why not ask for help? This not only gives you a chance to show off what you're working on, but also helps your followers feel more involved with your products – you might find that it speeds up development time as well.

**Below** Posts with images are more engaging than ones that are purely text

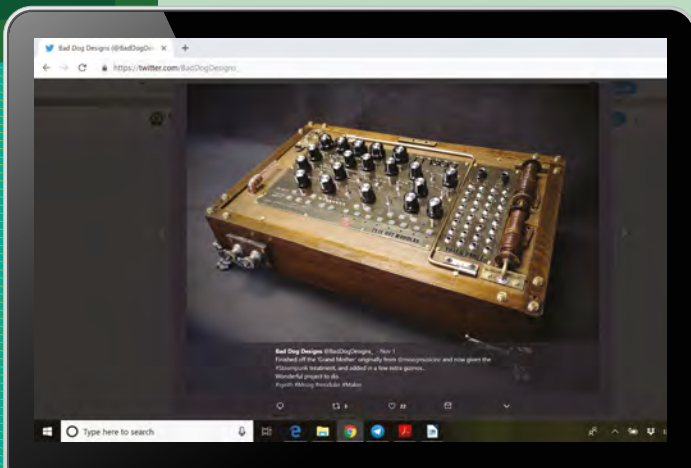
## What social media should you be on?

The big two social media platforms that you really should be on are Twitter and Facebook. Although Facebook has more users, the public nature of Twitter makes it a great place for communicating with your potential customers. As well as the big two, the visual nature of Instagram makes it a great choice for makers showing off their makes.

Social aggregators, such as Reddit, can drive huge amounts of traffic to you, but have specific cultures (and subcultures within different parts of the site). If you choose to go down this route, it can be best to take a little time to understand the sites before posting.

Google Plus was popular in certain spheres, but is now slated for closure, so is probably not worth getting involved with.

Smaller social networks, such as Snapchat, can be useful, but may not be worth expending time and energy on until you're working well on the more popular networks.



## Looking to improve

These tips should help you get started, but mastering your social media is something that takes time. Raspberry Pi's Social Media Editor, Alex Bate, guides you through the tricky waters of social media in her podcast: [soundcloud.com/howdoessocial](https://www.soundcloud.com/howdoessocial).

It's also good to follow some other makers doing great work on social media, to get inspiration for how to run a successful maker social media account. Here are a few of our favourites:

- Bad Dog Designs: [twitter.com/BadDogDesigns](https://twitter.com/BadDogDesigns)
- Lucy Rogers: [twitter.com/DrLucyRogers](https://twitter.com/DrLucyRogers)
- Evan and Katelyn: [twitter.com/EvanAndKatelyn](https://twitter.com/EvanAndKatelyn)
- Boldport: [twitter.com/boldport](https://twitter.com/boldport)
- Rob Ives: [twitter.com/robives](https://twitter.com/robives)
- Alec Steele: [instagram.com/alecsteele](https://www.instagram.com/alecsteele)
- Jimmy Diresta: [instagram.com/jimmydiresta](https://www.instagram.com/jimmydiresta)

People love in-progress shots and time-lapses of making. They can also learn from your failed experiments, as well as your successes. Your customers buy off you because you're not a major brand – help your readers peek behind the curtain and see what goes into your products (both the good and the bad) and it'll help cement your image as a real person, not a faceless corporation.

When starting out, keep it short. Even if you don't feel it's perfect, you'll get feedback about what works and what doesn't. If you are writing a tweet, instastory, or Facebook post, of course you should try to make sure it's accurate and grammatically correct, but it's not your magnum opus. An imperfect post that's sent is better than a perfect post that no one ever sees.

## BUILDING A BRAND

If you are on several platforms, try to get the same handle on all – it will help people find you easily.

Choose a primary publishing spot – a blog/WordPress site, or [hackaday.io](https://hackaday.io), or Instagram, or a Facebook page, etc. – this allows folks to easily see your past projects. Somewhere that allows long-form posts, and is easy to organise and search, is ideal. Keeping all your long-form pieces and major announcements in one place helps people find the major things that are happening with your business. You can send pointers to this on all your channels.

Let people know what other social media platforms you are on in your bios. That way, they

can find you on their favourite platform. You might prefer Twitter, but if a customer only ever checks Facebook, then they'll be missing your posts if they are unable to find you on their platform of choice.

## Your customers buy off you because you're not a major brand – help your readers peek behind the curtain

### STAY UP-TO-DATE

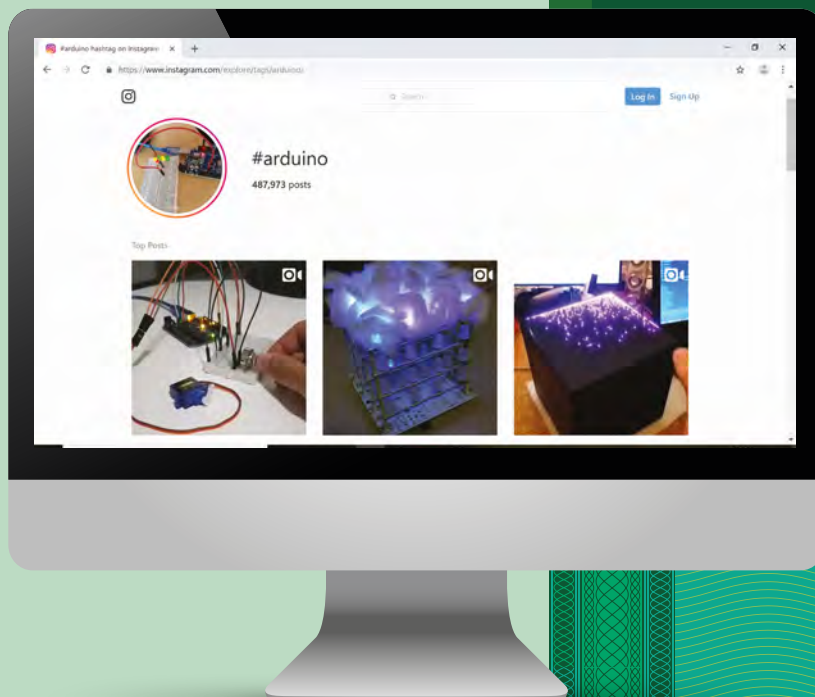
Post often, but if you can't, just post regularly. At least once a week is a good start. Try to post on a schedule, using whatever spare time you have. By setting a goal, you'll be more likely to keep the content coming.

It's best to post natively on each platform, to take advantage of the nuances of each platform but, if you don't have time, use tools like [bufferapp.com](https://bufferapp.com) (there's a free version available) to post to multiple platforms and schedule photos/content.

Also, most blogs have a plug-in that allows you to automatically post to Twitter, Facebook, etc. The results aren't perfect, but it's better than not posting. →

### Below

Both Twitter and Instagram use hashtags to link posts to certain themes. If you spend a little time finding the popular tags in your fields, it can pay dividends





# A Maker's Life

One pro maker's experience building a business

**T**o find out what life as a professional maker is like, we caught up with Paul Parry, the man behind Bad Dog Designs, who produces some spectacular Nixie clocks. Here's what he had to say about making your living running a

maker business...

For those of you who have not come across a Nixie tube before, here's a brief intro. Back in the 1950s, a company in the USA called the Burroughs Corporation came out with the first Nixie tube. This is a numerical indicator tube that allowed early electronic devices to display numbers, such as calculators, petrol pumps, and lifts (to let you know what floor you were on).

Being made from glass, they are quite fragile, and need a relatively high voltage, of 170V, to drive them. As soon as the LED became commercially available in the late 1960s, production of Nixie tubes dropped off, as the LED was a lot more robust, easy to drive, and was not limited to just displaying single-colour numbers from 0-9. However, as a display technology, there was nothing inherently wrong with Nixies; they last for decades and give a clear and bright digit. It was economics and progress which saw the end of them.

However, the story of the Nixie tube does not stop somewhere in the mid-1970s. There is a growing desire for all things retro and vintage, and this is where I come along. I love old electronic stuff, and remember Nixie tubes from when I was a small boy.

So, fast-forward 40 years, and I now use Nixie tubes to make retro clocks. I also use other pieces of old equipment to make the casings for the clocks, which is a form of upcycling and repurposing, which is how my business came about.

## DOWN TO BUSINESS

So, how does it all work as a business? Well, there are a couple of ways of bringing a clock into existence. The first way is to sit down and think

### Below

Theo Paphitis uses his twitter following to promote small businesses on the SBS hashtag



what someone might like to purchase, and then disappear off into the workshop and gather up all the parts and build it, and then hope that someone will like it enough to buy it. The other, much more fun, way is for the person who wants the clock to tell you what they actually need, and then you make it specifically for them – you are guaranteed a sale, as you are building exactly what they want. In effect, they are commissioning you to convert their ideas into a reality, which is what I do.

### There is a growing desire for all things retro and vintage, and this is where I come along

It doesn't happen overnight. People need to know that you are there and that you can make things for them. I started off by making clocks and then trying to sell them. I did this for about six months, before someone then asked me to make one specifically for them. I sold a lot on eBay initially, which also worked as advertising, as people were seeing the clocks, even if they didn't buy them. As I made more clocks, I started selling less on eBay, and more through my own website, and also pushing lots of pictures of them on social media. I now do exhibitions as well, where I get to show the clocks directly to the public, and I find this is a great way of getting what I do into the minds of people who have never even heard of a Nixie clock, and would never have known that they were something they could buy or get made; it's more of an education or awareness. Why would anyone who had never come across a Nixie clock, try to find one on the internet, for example? They wouldn't – you have to shout as loudly about what you do as you can!

**Right** ◆  
Old components are a great way to add some aesthetic interest to your builds

The commissioning process is not as straightforward as you might think. In my experience, people love to have something made just for them and tailored to their needs, but they don't always necessarily know what they want, or what is even possible. This is where having a good range of previous work is very useful. You can usually gauge from initial talks with the person roughly what they are looking for, number of tubes/size of tubes etc. But if you can then show them a picture of something you made, say a couple of years ago for someone else that was close, you can then use that as a start point, and then develop the specification for the piece that they want you to make. To that very end, as a lot of my work is made from old equipment or vintage items, I have a whole section on the website simply called 'Starting Points', and it is literally a collection of items they can go through, and I will use whatever they select as the base for the clock. If I don't have the initial item in the list, they can let me know what is nearest, and I will then go looking for something to fit the bill. Other times though, the client will give me an item to work on.

Once it has been decided what I'm making, and a specification has been agreed upon, then I can look at the design side of the project. →





# A Maker's Life

The clock part of the design is relatively easy. I have made hundreds of unique clocks, and I have standard circuit boards for four-tube or six-tube configuration.

I have lots of modular parts, so I can add in WiFi connectivity if needed, or if there is to be more decorative elements to the design, I have an arsenal of Dekatron tubes, LED lighting effects, and other shiny gizmos I can add in. What I enjoy is the challenge of doing something I've not done before, and working out how to realise that as an actual piece. It pushes me and makes me think. An example would be when a client asks if the clock

could have a mechanical chime, but not the usual Westminster chimes, but it would be nice if it could play a piece by Mozart, or a bit of The Prodigy!

Another aspect of the design and build is also reliability: you are making a piece for someone that they are paying good money for, it has to last, and you don't want the customer coming back a month later telling you it has packed up or broken. It's not good for your reputation, and you don't want to be spending your time on fixing things when you have got paid work to be getting on with.

I take this side of things very seriously. I quite happily spend three hours neatly wiring up something – to individually sleeve and heat-shrink every soldered connection – that you could do in 20 minutes if you were making it for yourself and were not really

## The other difficult part, and probably the hardest thing to get right, is how you price your work

bothered what it looked like inside. I use the best-quality components I can find, regardless of cost, and take no shortcuts on the construction or finish of a piece. So far, this has served me well; it is very rare indeed that a clock comes back. I can count on one hand where the client has had a problem a few years down the line, and still have some spare fingers!

### THE NITTY GRITTY

The other difficult part, and probably the hardest thing to get right, is how you price your work. You can't really stick to a traditional formula where you take the cost of the bits, and say multiply it by three, and then hope for the best! Likewise, you can't realistically either set yourself an hourly rate and then add up the hours taken, plus the cost of the parts, and say a 40% margin for overheads and some profit, so you can continue trading. You might make a small clock and spend a whole week on it; if you did 40 hours a week, and set yourself an hourly rate of £50/hour, then you are looking at £2000 just in labour, for a clock with a perceived value of about £300.

#### Left

Once you gain a reputation in one area, such as clock making, people may approach you to work on others





**Right**  A shelf of parts can help inspire customers

So, how do you come up with a value? Well, you need to cover your costs, add up the value of the components, and then make a note, it's not worth doing it if you make a financial loss! For me, the rest of the process is about time and more emotional; there is no set formula. I would look at a clock I have made and say to myself – how much would that cost, if it were in a gallery in New York, or in the window of a shop in Chelsea? OK, maybe that will never happen, but just as a clock that cost you £2000 in time alone to make, has a perceived value of £300, it can also work the other way round. You could be asked to make a clock for someone, that

has a relatively low-cost value – at the end of the day, I'm using a lot of reclaimed parts, with some modern electronics inside to drive the Nixie tubes. But the finished piece has been made specifically for an individual, their ideas have been converted into reality, and they can see the level of detail, care, and workmanship that has been put into the piece, and appreciate the time taken to do so, and that is where the value is added.

When I get approached to make a piece, I cannot quote an exact figure – I've not made the item yet, and don't know how long it will take me, and what obstacles I will come up against. I therefore quote a price that is based on what I have sold similar specification clocks for. There have been many clocks where I quoted a price and got the work, only to realise I had spent far too long making it. You do get a feel for things over time though and also, as your reputation grows, your work does become more in demand. The best way to imagine it is like a set of scales: on the one side you have the value you put on your work, and on the other side the number of clocks that people ask you to make. If I decided to put a small handmade, bespoke clock for sale at £100, then I would get more people asking for one than I could even cope with. If I decided to put the same clock for sale at £1000, then there would be no one asking and I would go out of business!

When I started out, the scales were definitely at the lower price end, but over the years they have levelled out at a point I am happy with, so I can keep a business running, and also I get enough customers giving me work, but it is all experience I have learnt along the way. □

## My journey

Being a professional maker was a dream that took some 40 years or so to achieve. I consider myself retired from the nine-to-five, and I know that I am very lucky to be able to follow my passion for a living. If you ever decide to make the leap, you will then find yourself working more hours than before. It becomes all consuming and it's constant, full on, and always in your head. Days off become a rarity and, when they do happen, you find yourself thinking about making stuff! However, you don't care because you are doing it for yourself and no one else.

I must add, though, it is by no means easy; you need help and a lot of support along the way. I could never have made the jump to full-time making without the encouragement and faith my wife has in me. It is a big piece of the formula; there are times you ask yourself if you did the right thing, and a reassuring smile and nod of the head from your partner is probably one of the most supportive and warm feelings you can get. If you are doing it totally alone, then you are in for a long and scary path, but persevere, as making for a living is so totally rewarding.



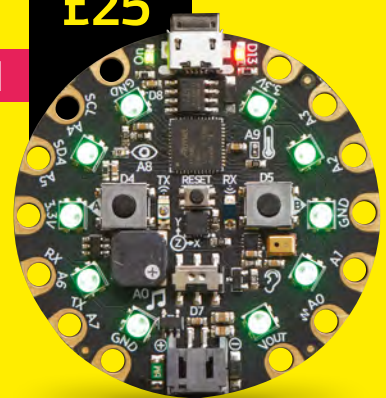




# CIRCUIT PLAYGROUND EXPRESS

WITH 12-MONTH PRINT SUBSCRIPTION

WORTH  
**£25**



FROM JUST  
**£55**

12-month  
subscription  
from **£55:**

- UK: £55 per year
- EU: £80 per year
- US: £90 per year
- RoW: £95 per year

Offers and prices are subject  
to change at any time

Visit: [hsmag.cc/subscribe](http://hsmag.cc/subscribe)

# SUBSCRIBER BENEFITS ↓

**SAVE UP TO 35% ON THE PRICE**  
**FREE DELIVERY TO YOUR DOOR**  
**EXCLUSIVE OFFERS AND GIFTS**

## OTHER WAYS TO SUBSCRIBE

### Quarterly subscription

**Get your first three  
issues from £5:**

- Use the code HS-SAVE at the checkout
- Spread the cost of your subscription
- Try out HackSpace magazine with no commitment

### Rolling subscription from just £5 a month:

- Quick and easy to set up
- Cancel any time
- No long-term commitment
- No large up-front cost

## DIGITAL SUBSCRIPTIONS ALSO AVAILABLE



**Visit: [hsmag.cc/subscribe](https://hsmag.cc/subscribe)**



HackSpace magazine meets...

# Wilbur Pan

The tools of Japanese woodworking

**Y**ou may have seen GIFs on the internet of Japanese woodworking joints, slotting together like a satisfying round of Tetris. Whereas the most advanced technique you'll see in typical Western joinery is a dovetail, Japanese joinery is magically, seemingly impractically, complicated. We wanted to know why the simple business of taking one bit of wood and joining it to another has turned into such a baroque art form, and how techniques got so different at opposite ends of the world.

That's why we were delighted to meet Wilbur Pan at Maker Faire, New York. His website, [giantcypress.net](http://giantcypress.net), is the most relaxing way to waste time on the internet if you're interested in anything made of wood. He set us straight on a few things, gave us serious tool envy, and showed us why the Industrial Revolution might not have been all that great after all. →

**Right**  Wilbur Pan, demonstrating the tools and techniques of Japanese joinery



Maker Faire  
MAKER  
WE BOP  
MAKE CRAFTS  
NEW YORK 2011


DIY Content Creator Stage

DIY Content Creator Stage

DIY Content Creator Stage





Below  A thinner blade not only means cleaner cuts, but less wood removed, and less effort wasted



**HackSpace** So, Japanese joinery. Why is it so different from Western joinery? It's not just the aesthetics; there are whole joints that are unknown in England, and it all seems needlessly over-complicated.

**WP** Japanese joinery itself came from architecture, and that actually stems from Chinese woodworking techniques. Basically, going back to the Tang Dynasty – so the year 800 going forwards – China was the dominant political, economic, cultural, philosophical, artistic centre of all Asia. So everything you see in Southeast Asia has roots in China. If you look at Japanese temples and Chinese temples, they look very similar.

Now, over time they put their own spin on it to the point that, if you know what you're looking at, you can tell the difference between a Japanese temple and a Chinese temple. But the roots are the same.

One of the theories that people are interested in is that they think that one of the reasons Japanese joinery is so complicated – because the joinery they use in their buildings tends to be more complicated than we see in a Chinese temple – is that Japan is on the Ring of Fire. The whole country's a volcano, and there are a lot of earthquakes. And it turns out that these joints are really good at resisting earthquakes, because they provide strength where you need it, and also provide flexibility, so, when there's an earthquake, the joint doesn't shatter and come apart.

There's a bunch of people interested in Japanese carpentry techniques in the Bay Area, and one of the tasks they've taken on is trying to convince builders to use these techniques, because they have earthquakes too. Their feeling is that all the buildings that have gone up are just going to come down again the next time we have a big earthquake; whereas there are buildings that were built on the other side of the Pacific, using these techniques, that have been standing for hundreds of years.

**HS** Is there a difference in the woods used in Japanese and European joinery?

**WP** There are different species. In general, with woods there are two big categories: softwoods and hardwoods. But I think those are bad terms, because they don't really describe the structure of the wood. Really, what you're talking about is evergreen trees and deciduous trees. So hardwood comes from trees whose leaves fall off, and softwood comes from trees with needles, like pine.

Just to give you an idea of why these terms aren't all that useful, there's a type of wood called basswood, which is the softest wood that's out there, but it comes

"

They didn't have a table saw, they didn't have a band-saw, they didn't have jointers or planers, but they had to take these pieces of rosewood and make boards out of them

"

from a hardwood tree. Whereas on the other hand, the type of Douglas fir that's used for making two-by-fours, stuff like that; over time, the resin in Douglas fir just hardens up rock-hard. My house is about 70 years old, and it has all these exposed boards that are made out of Douglas fir. It's technically a softwood, but I tried to drive a nail into one of the boards in my house, and it was impossible. I had to drill a hole.

So in Japan for architectural work, they tend to use species of cedar and pine, because the properties of those trees lend themselves to architecture: they grow very straight and they grow in wide diameters, which is what you need. Trying to make something like that out of maple, you would have a hard time finding those trees.

In terms of furniture making in the West, we tend to use more hardwood, so maple, cherry, walnut. In Japan, there actually isn't a furniture tradition; in a traditional Japanese house you have a cabinet to

store things in, and everything else will be built-in. You'll sit on the floor, sleep on the floor.

In China, there's a furniture tradition, but the woods they use are really just what they had lying around, if you're talking about regular people who just wanted to bang together a chair or something.

For a lot of really nice Chinese furniture, it's all rosewood. That's actually one of the things I've been trying to figure out, is how did traditional Chinese furniture makers do their thing? Back in the 1400s, there wasn't a lot of woodworking technology available. They didn't have a table saw, they didn't have a band-saw, they didn't have jointers or planers, but they had to

take these pieces of rosewood and make boards out of them; they had to use hand tools.

**HS** What about glue? Couldn't they just glue boards together?

**WP** No, because rosewoods are so oily that glue isn't going to hold them together. They didn't have polyurethane back then. I wrote an article for Popular Woodworking, that came out in mid-2018, on

Chinese furniture, about the things that I learned when I visited China. It was a real eye-opener. It was the first time that I'd had the opportunity to look at a lot of Chinese furniture

The second thing I learned is that the trees that they used were often hollow in the middle, so when you think of a tree that you cut down to make something, like a cherry tree, you're expecting to see a solid block. But these rosewoods, that grow in Southeast Asia, produce cylinders of wood.

They also take a very long time to grow. When you get a tree to a big enough diameter, you think you can use it, so you cut it down and it's hollow, you're left with a cylinder of wood. You can slice it up and make boards out of it, but the result is that the maximum size of the boards is going to be around ten to twelve inches wide.

The thing is that if you make furniture, you're building to a human scale. →





Above ■  
The Ryoba saw that Wilbur's using here has rip-cut teeth on one edge, and cross-cut teeth on the opposite edge



Whatever size of item you have in your house, it's probably going to be around the same sort of size in my house. If you build a cabinet, it's going to be around 20 inches deep, because that's human-sized. Anything deeper than that is too long to reach in and grab whatever's inside. So, what you have is boards that are eight to twelve inches wide, but you need to make something that's 20 inches deep, or say a table that's 36 inches, and you don't have glue. How do you do it?

The only way you can do it is to make these completely elaborate joints to hold everything together, so the joinery in Chinese furniture tends to be really complicated. The question we started out with was: why would anyone do that? The reason was, they had to.

That's interesting to me because, from a mechanical standpoint, you don't need a joint that's that complicated to join a table leg, or to join a chest of drawers together. But, for a building that's going to be undergoing earthquakes, you do need complicated joinery. So it's like the Japanese joinery tradition evolved the way it did for a completely different reason.

**HS I guess a lot of it must be purely because of tradition, too?**

**WP** When I first started learning about Japanese tools, there wasn't a whole lot of useful information. What I found when I asked about Japanese tools, and how they worked, was that I would get one of two answers.

Answer number one would be: "The tradition is so deep. The blacksmith who's made this chisel is 80 years old and has spent his entire time perfecting his craft. His kids aren't going to pick up that tradition. So, buy the chisel before the guy dies". Now, I'm sure all that's true, but it doesn't explain anything at all.

And they talk about "Oh, you're at one with the tool, wood has a certain spirit", and for me, I'm Chinese, so I grew up with that stuff. So I'm actually not impressed by it. The analogy I use is that my wife's

a Catholic, and I didn't grow up religious. When we got together, we would go to mass and I was completely fascinated by every aspect of it. She would be like "Why are you asking that? It's just what we do!"

So from my understanding, I didn't think about Japanese, Chinese, Asian woodworking as philosophical. I look at it as: "We've got these woodworkers, and these sharp pieces of metal, and what they want to do is use these sharp pieces of metal to shape wood, so they can build stuff." So, from that standpoint, Japanese woodworkers and Western woodworkers are the same. Once I started looking at the similarities between Japanese woodworking and Western woodworking,

"

If there's any difference I've found between the current state of Western woodworking tools and Japanese tools, it's probably nothing to do with Zen or philosophy. I think it's the Industrial Revolution

"

I was able to figure out how these things work. That's a lot of what I've been writing about over the years, on my blog and in magazines.

**HS Tell us about the tools that you use. All of this looks recognisable, but it's all still very different.**

**WP** You know these things really look different, but in many ways they're actually the same as traditional Western woodworking tools. If there's any difference I've found between the current state of Western woodworking tools and Japanese tools, it's probably nothing to do with Zen or philosophy. I think it's the Industrial Revolution.

To make a laminated chisel like this [holds up deadly-sharp Japanese chisel], you need a blacksmith. You're not going

to automate what a blacksmith does in a factory. So what do you do? You change the construction of the chisel, and that's why Western chisels are made from a solid piece of metal, rather than laminated. In Japan, they're still doing things the traditional way because the Government has decided that it's worthwhile to try to keep these traditions alive. Honestly, if you were a Japanese blacksmith, and you didn't have that support, you'd go out of business. There aren't enough people buying these tools.

**HS That makes it sound as though Western chisels used to be made like that, with a laminated blade?**

**WP** Yes. This is a plane blade, but it's the same. So this plane blade has the same hard layer, soft layer, and lamination line, but it's a Western plane blade. Made by William Ash and Company, warranted cast steel. Completely Western toolmaker. I think they were located round New York. But the construction is the same, and this is pre-Industrial Revolution.

Once the Industrial Revolution came along, the methods changed. They had to find a piece of steel that they could put in a factory and make tools out of. So what do they do? Western chisels tend to be less hard than this, to make them easier to manufacture, so you end up with tools that are less good at retaining their edge.

**HS Pretty much all I know about saws is that the teeth are slightly different, depending on whether you want to cut across the grain or along the grain. Is that the same with these Japanese saws?**

**WP** There are two forms of Japanese saws. The more common one is a Ryoba. They have teeth on both sides, one side with the teeth cut for rip saw, one side cut for cross-cut saw. Then there's the Dozuki, which is a finer saw. Compared to the Ryoba, it's much thinner, which is why it needs a back on it to give it extra support. →





**Left** ↔ Like the saws, Japanese planes work with the pull stroke, and remove less wood than a typical Western plane

**Right** ↔ Some high-end Japanese saw blades are thinner in the centre, so they don't stick in the wood

That's what you'd be using to cut really fine joinery. The Ryoba leaves a pretty good surface, but the Dozuki will leave an even finer cut.

Because the teeth are so tiny, this is a slower saw; I generally pick up the size of the saw to match the size of the thing that I'm trying to do. Bigger boards, bigger saw.

These tools cut on the pull stroke. Western saws you push to cut, Japanese saws you pull. What I tend to do when I'm sawing a piece of wood is I just figure out where I want to start, and figure out where I want to end, and I focus on the end part. This is going to be a little bit of a stunt.

[Marks the start and end of the cut, and flawlessly cuts a straight line, without even following a pencil mark.]

I have to say, I don't think I can do this because I'm some freakishly talented woodworker. I think it's really just how the tools work.

The other benefit of this is that, because the saw's being pulled, you can make the

steel thinner. Because the steel's thinner, the kerf doesn't need to be as wide, so the cut end of the wood is smoother.

**HS You've convinced me. How much would these things cost if you wanted to start getting into using Japanese tools?**

**WP** First of all, it does cost money to buy a set of tools. But it probably doesn't cost as much money as you think. The first thing you would need is a sharpening system. That can get pretty pricey, but it's the sort of thing that you only have to buy once and you're going to use for the rest of your life. The three stones I have, plus the diamond plate, probably cost about \$350, which is a lot, but if you're into woodworking you'll use it every single day. The saws are about \$45 each, and you only need three to cover all your needs for joinery, furniture making.

I have a big set of chisels, just because when I put them on the wall of my shop it looks really nice. But you really only need

probably three. There's a wide range of Japanese chisels, but you can get a decent one probably for \$30–\$40. So, you have your chisels, you have your saws. Planes are another important tool if you're going to be working by hand. I actually, even though I use Japanese planes all the time, I actually don't suggest that you get into Japanese planes unless you really, really want to, because it's so much easier to set up a Western plane, and Western planes are going to be cheaper. You can get a Stanley No 4 for \$30 or so. And then, a couple of hammers. Mine are all Japanese hammers, and although it might not look like much, there's actually a lot that goes into this. The metal that makes this end and this end over here is harder than the stuff in the middle. What that does is it allows the striking face to stay true and flat all the time. This is the last thing that I bought, and I only bought it because it looks so nice.

That'll give you an idea.



**HS** Do you have to sharpen these saws every time you use them, and is there a certain process to doing that?

**WP** There are Japanese saws you can buy that you can sharpen. They tend to be pricey because they're made by blacksmiths. These saws are made in a factory, and the blades are replaceable. The blade replacements tend to be about \$30. But the teeth will last you a really long time. This is the saw I probably use most often, and it's been... probably four years since I replaced the blade. It's still going. I might replace it next year, if I remember to do so. I don't mind spending \$30 on a blade every five years.

If you're concerned about the cost, remember that a lot of this is startup costs. And what I would do, if you're interested in woodwork, first thing to do is figure out what your project is. Once

you've done that, buy the tools to make that project. For your first project you're not going to have to buy a lot of stuff. Then you decide what you need for your second project, and you'll need only a couple of things for that.

“

**If you're having trouble with a Western saw, or you don't have much experience overall, then go with the Japanese saw**

**HS** What's your number one bit of advice on getting hold of this gear?

**WP** So even then, if you already have the tools, just buy what you want to get into. Just to give you an idea, what I usually tell people is different from what a lot of

Japanese woodworking guys would say. A whole lot of other Japanese woodworkers would say "only use Japanese tools, they're the best, and you're crazy to use anything different".

I'm a little bit more pragmatic. So I think that if you're good at using Western handsaws, there's no need for you to buy a Japanese saw, because you're going to have to unlearn how to do it with a Western saw. But, if you're having trouble with a Western saw, or you don't have much experience overall, then go with the Japanese saw.

“

But, I do think that everyone should use Japanese chisels, unless you want to spend more time sharpening. These things are not going to wear out in a hurry. This chisel, even though you grind it down every time you sharpen it, this chisel is ten years old... it's going to last longer than me. ▣



# HACKADAY PRIZE: THE WINNERS

The academy awards of open-source hardware have been given out. Here are the big winners who are going to shape the future

**A**fter a competition lasting nine months, with nearly 1000 entrants and \$200k given away as prize money, the winners of the 2018 Hackaday Prize have been announced.

Drawn from categories including power generation, robot-human interaction, and more, all entries have to satisfy several judging criteria, but the most important is that they need to have the potential to change the world.

We think the five winning entrants here all satisfy that condition in their own way. Whether the breakthrough is in ease of use, or assembly, or bringing the cost of technology down to a more accessible level, all five of these creations deserve big congratulations from all us humans as we move into the future.

5<sup>TH</sup>

## PR-HOLONET

Maker Hadi Esiely | Prize Money \$5k

W

hen Hurricane Maria struck the island of Puerto Rico, the damage caused was huge. Apart from the initial devastation caused by the hurricane itself, the knock-on effects on sanitation and power caused even more damage to the island's communities. The destroyed communication infrastructure severely impaired the ability of emergency services to get the island back on its feet.

PR-Holonet, which has won fifth prize and \$5k for its creators, was built to help when communications infrastructure has been damaged by natural disaster. It can be used by any device with WiFi and a web browser to send and receive SMS messages. It uses the Iridium satellite network, is powered by a 5V power source (so a phone battery, micro USB, or solar power will all work), and is designed so that a non-technical person can have it up and running in ten minutes. □

4<sup>TH</sup>

## EMOTIGLASS

Makers David Prutchi and Jason Meyers | Prize Money \$10k

O

ur emotions are affected by different visual stimuli. A human face, a baby, a cute puppy, an angry dog – all these produce emotions without our realising it. Based on research conducted at the University of London, David Prutchi and Jason Meyers have created EmotiGlass, an augmented reality wearable that helps the wearer control stress and anxiety.

Images introduced at different stages of our heartbeats induce measurably different effects on our emotional states, and we've known for a long time that there's a difference between left and right parts of the brain. The therapeutic applications of EmotiGlass are potentially huge, so we're going to monitor this closely. □





# 3<sup>RD</sup> PORTAL POINT GENERATOR

Maker Vijay Varada | Prize Money \$15k

**W**e're told that necessity is the mother of invention. That's why when Vijay Varada couldn't find a suitable electric generator to take on his trip to Antarctica, he designed his own. This 3D-printed model is driven by a wind turbine and produces up to 100W of electrical power.

Vijay used a Dual Axial Flux Generator, which consists of two sets of magnets rotating on either ends of an axis, with a fixed stator (the bit with the copper wiring) sandwiched between them. Compared with a radial flux generator (as seen on most generators made out of repurposed DC motors), this construction is efficient and easy to 3D-print. The flat construction also makes it easy to integrate into other projects. That's well worth the \$15k prize money for coming in third place. □



# 2<sup>ND</sup> TINGLE WEARABLE

Maker Curt White | Prize Money \$20k

**O**ne of the ways in which OCD (obsessive compulsive disorder) manifests itself is compulsive self-injury such as hair pulling, scratching, and cutting oneself, as well as other less severe behaviours such as thumb sucking and nail biting. These are easy to observe but hard to measure – who has the time to sit down and quantify how much, how often, or how strongly someone pulls their hair every day?

That's the problem solved by Curt White with the Tingle device. It's worn on the wrist and provides real-time haptic feedback when it detects repetitive actions. It can also send information for collection by doctors over Bluetooth, and perhaps best of all, it started life as a hacked fitness tracker. □



1<sup>ST</sup>

## DEXTER

Makers Kent Gilson and Todd Enerson | Prize Money \$50k

**D**exter is an open-source robotic arm that is trainable by the human hand. It's mostly 3D-printed, as you'd expect, but the really clever bit is the way that it's controlled. It has five axes of movement, which are controlled by NEMA 17 stepper motors. These are pretty cheap and don't have encoders (to monitor the movement of each of the joints), meaning that they're prone to slipping and have no way of measuring how far they've slipped. This loss of accuracy is one of the big differences between expensive and cheap robot arms.

So the team did what good teams do: built their own optical encoders and mounted them on the motors' axes. Dexter uses two sensors per axis, with one 90 degrees out of phase, then interpolates the values at sin and cos values. Turning digital to analogue data like this vastly increases the processing power required – Dexter takes five million measurements per second – so the team used an FPGA to handle the computational demands.

**CONTROL**

Dexter isn't only incredibly precise, it's also easy to use: "We wanted Dexter to be easy to program to someone new to robotics and [with] a basic understanding of code", say Kent and Todd. "One of our team members created Dexter Development Environment. It uses a modified version of JavaScript due to accessibility and it comes with documentation on how to program Dexter in DDE."

"Dexter uses a socket connection for DDE, but that isn't the only thing that has used it. One of the members of the Dexter community has actually developed a Unity library for use with Dexter. Using 'follow me' mode, you can actually move Dexter around in virtual reality to interact with objects. Touching one will provide haptic feedback in the physical Dexter. We think this is really cool because that opens the door for Dexter to potentially be used as a game controller." □

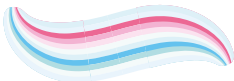






# TOOTH BRUSH

They help keep your teeth shiny, and here's how you can use them to shine your maker creds



**Mayank Sharma**

[@geekybodhi](#)

Mayank is a Padawan maker with an irrational fear of drills. He likes to replicate electronic builds, and gets a kick out of hacking everyday objects creatively.



**robably the one similarity between us and the Sumerians of Mesopotamia is our shared dislike of the trips to the dentist.** This would

explain the discovery of chew sticks, the predecessor of the modern-day toothbrush, in excavation sites dating back to 3500 BCE. While the chew sticks are still popular in certain parts around the world, it's the toothbrush that's become the tool of choice for maintaining oral hygiene. The earliest known users of bristle-bearing toothbrushes were the Chinese, who used the flexible yet resilient Siberian hog hair for bristles back in the 15th century. These were attached to a handle fashioned from bamboo or bones. It took a couple of centuries for the Chinese toothbrush to make its way to Europe. (In case you are wondering, up until then Europeans rubbed their teeth with a piece of cloth or sponge dipped in a solution made of sulphur oil and salt.)

English entrepreneur William Addis was the first person to mass-produce toothbrushes in 1780, while the first patent for one was granted to American H.N. Wadsworth in 1857. The first evolutionary change in the toothbrush's design came about thanks to the

First World War. Since soup bones couldn't be spared, manufacturers created handles with celluloid. They'd then drill holes in the handles to attach the bristles. The Addis version of the toothbrush used cow tail hair. Later versions of the European toothbrushes, like the one used by Napoleon, replaced the hog hair with softer horse hair. Despite their popularity, animal bristles were never an ideal material for a variety of reasons, mainly due to their animal source. In 1938, DuPont solved this problem when it introduced a toothbrush with synthetic fibres made from nylon. Brushing teeth became a daily ritual due to DuPont's marketing campaign during the Second World War, which reminded American citizens that it was their duty to stay healthy by brushing their teeth. In 1961, an alternative to the manual toothbrush came in the form of an electric one from Switzerland, and by the late 1970s the toothbrush industry started churning out a variety of new designs that differed in bristle shape and size.

These days, you can do a lot more with toothbrushes than just scrub your teeth. Their use as a fine cleaning device is fairly popular, and it doesn't take long for an enterprising maker to whisk one for a creative purpose.

# DIY ELECTRIC TOOTHBRUSH

**M**akers like Roman Ursu don't let go of a do-it-yourself opportunity just because something is available off-the-shelf. So, while electric

toothbrushes aren't really expensive, he'd still put in the effort to electrify a manual one. The build isn't component intensive, and the process isn't complicated either. Before you begin, make sure none of the tiny particles from the ensuing process get into the bristles, by wrapping that end with some kitchen foil. Then, cut the handle in two places to place a tiny vibrating motor in the upper part, and a battery at the lower end. After chopping the handle, you'll have to drill holes in them to place the motor and the battery. You'll also have to make a

hole through the central column of the handle to pass the wires, and another at the top to place a switch to toggle the motor. Follow Roman's instructions in the video to connect the battery to the motor via the switch. Once they're all hooked up, hot-glue the handle back together and you're good to go. The hot glue also makes it possible to easily replace the battery when it runs out. □

**"DON'T LET GO OF A DIY OPPORTUNITY JUST BECAUSE SOMETHING IS AVAILABLE OFF-THE-SHELF"**

Project Maker

**ROMAN URSU**

Project Link

[hsmag.cc/GJcCWC](http://hsmag.cc/GJcCWC)



**Left** ♦ Use this electric toothbrush to massage your teeth after working them through a lavish meal



FEATURE

# TOOTHBRUSH BRACELET

**T**ori has found another crafty use for the toothbrush handle by moulding them into bracelets. To replicate her build, you'll need to make sure you use toothbrushes with plastic handles.

Start by plucking out the bristles. Tori suggests you can ease the process by sticking the bristles in hot water to loosen their holes. After removing the bristles, carefully submerge the entire toothbrushes in a boiling pot of water for about three to five minutes. Use pliers to remove the toothbrushes from the boiling water, and place them in hand towels. Now, pick the softened toothbrushes with the hand towel,

and bend them into the shape of a bracelet. When you're done, place them into a bowl of cold water for about five minutes, until they harden once again. If you're not satisfied with the shape, you can place the bracelets in the pot of hot water, and reshape them once they are malleable again. □

**Project Maker**

**Tori**

**Project Link**  
[hsmag.cc/natHmj](http://hsmag.cc/natHmj)

**Below** ♦

If you are concerned about hygiene, you can use new toothbrushes, but Tori says that boiling them should get rid of all the germs



# STACKED HANGER

**E**ven when the business end of a toothbrush (i.e. the bristles) are worn out, you still have a sturdy handle that hasn't lost its usability. That's exactly what went through Shipra's mind

when she decided to craft a stacked hanger using old toothbrushes. She neatly clipped away all the bristles, and then used hot glue to tightly wrap a piece of jute string around three toothbrushes. She then took two lengths of the jute string, and made a loop in the middle that would be used to dangle the hanger. Next up, she attached the toothbrushes to the string on both sides of the loop, using a

combination of knots and hot glue to hold them in place. Watch the video for a visual guide to create the knots and stack the toothbrushes. Snip any remaining string at the end. When you're done, use the top loop to hang the stacked hanger. □

**Project Maker**  
**SHIPRA**

**Project Link**  
[hsmag.cc/WHhotR](http://hsmag.cc/WHhotR)

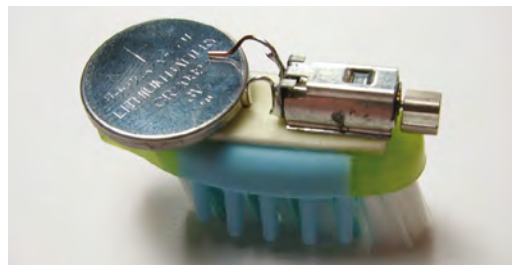
**Right** ♦ Shipra's YouTube channel has lots of videos to help you use all kinds of discarded household items for creative purposes



# BRISTLEBOT

**V**ibrobots are a simple class of robots that are driven by a vibrating motor. They are easy to build, and very popular because of their simplicity. Designed by the makers at Evil Mad Scientist Laboratories, the BristleBot is a type of vibrobot that uses the bristle-end of a toothbrush. "BristleBots are inspired by the seeds at the end of a stalk of grass which, if you squeeze them gently, will push through your hands in one direction, but won't move backwards," shares Lenore. The team looked through all kinds of brushes and brooms that would show off that kind of directional motion: "Eventually, we found the right thing in modern toothbrushes, which were starting to experiment with pointing the bristles in a variety of directions. From there, it was easy to put a vibrating motor and a battery on top." The BristleBot was an instant success: "At the 2008 Bay Area Maker

Faire, we had a table for BristleBot building. We wrote out a set of instructions, set out materials and tools, and put out a tin with a slit in the lid and a label suggesting a \$2 donation for materials. We lined the edges of the table with empty IC tubes, to provide a barrier to keep bots from zooming off the table. There was often a crowd around the table, and there were usually several BristleBots buzzing around." □



**Project Maker**  
**LENORE EDMAN**

**Project Link**  
[hsmag.cc/wgwYjw](http://hsmag.cc/wgwYjw)

**Left** ♦ Make sure you use a toothbrush with angled bristles, and trim them to a uniform length



# HackSpace

TECHNOLOGY IN YOUR HANDS

## Download the app

Out now for smartphones & tablets



**£2.29**

rolling subscription

or

**£26.99**

subscribe for a year





# FORGE

HACK | MAKE | BUILD | CREATE

Improve your skills, learn something new, or just have fun tinkering – we hope you enjoy these hand-picked projects

PG  
70

## KNIFE SWITCH



The ultimate switch for safety-conscious mad scientists

PG  
76

## NFC CUFF-LINKS

Hide your data when attending black-tie events

PG  
82

## PLAY-DOUGH

Ditch wires! This child's toy works as well (almost)

PG  
86

## DOOR HANGER

Keep your room safe with a personalised message

PG  
62

## SCHOOL OF MAKING

Start your journey to craftsmanship with these essential skills

62 Transistors  
68 Screwdrivers

PG  
92

## ROUTING

Tidy your workshop and learn to use this handy wood tool



PG  
96

## GLOVE SAMPLER

Build a musical instrument you can wear

PG  
104

## DIY ROBOT

Create your Arduino bot from scratch



# Electronics 101.5: Transistors

Switching and amplifying: the heart of modern electronics



Dave Astels

[daveastels.com](http://daveastels.com)

Dave's career started in the 8-bit days, with the Z80 and 6502, and he's been working with computers ever since. Check him out at [daveastels.com](http://daveastels.com) and [learn.adafruit.com](http://learn.adafruit.com)

**N**ow things get exciting. We've looked at the basic passive components, and the simplest semiconductor: the diode. In this instalment, we delve into the workings and uses of the component that shook the very foundations of modern electronics, and made possible the digital devices we rely on: the transistor.

## THE MOST SIGNIFICANT INVENTION IN RECENT HISTORY

Before transistors, vacuum tubes were used for signal amplification and switching. Look inside an old television or radio and you'll see the tubes gently glowing. Each one is the average size of an adult thumb (give or take a bit). The early digital computers were built from tubes. ENIAC (1946) had over 17 000 tubes, consumed 150kW of power, and had a tube fail every two days, on average. That's enough electricity to run about 15 000 Raspberry Pi 3B+s, with some left over. A bit of research shows that one of those Pi3B+s is around 250 000 times as powerful as the ENIAC (in terms of operations per second). It's also far less expensive: ENIAC cost over \$6 million in today's money.

Vacuum tubes were big, slow, power-hungry, and failure-prone. There had to be a better way.

In 1947, three researchers at Bell Labs (John Bardeen, William Shockley, and Walter Brattain) invented what they called the transistor (because it exhibited 'transresistance'). From that beginning, transistors went on to become the pivotal component that pretty much all of our current electronic devices are based on. Any modern computer is loaded with transistors.

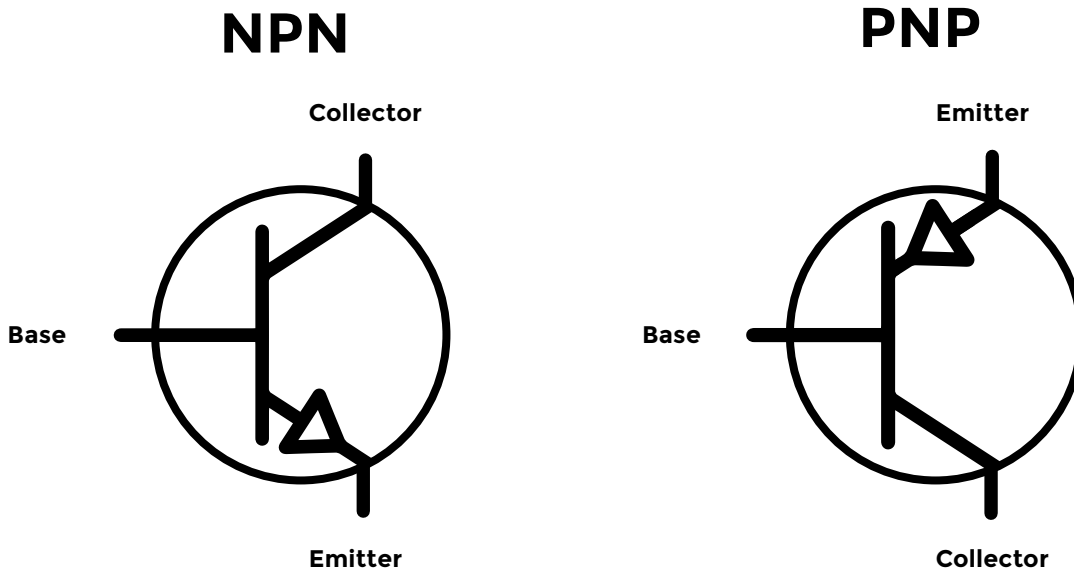
There are two primary types of transistors: bipolar junction, and field effect. We'll focus initially on bipolar junction transistors (BJT for short). BJTs come in two flavours: NPN and PNP. In the last issue

we looked at the diode. We talked about N-type silicon and P-type silicon, and how the junction between a piece of each was the key to the diode's operation. A transistor is very similar. The big structural difference is that instead of two pieces of silicon it has three, arranged like a sandwich. An NPN transistor has two layers of N-type silicon, one on either side of a piece of P-type. A PNP transistor has two pieces of P-type, sandwiching a piece of N-type.

As mentioned, a transistor has three connections. BJT schematic symbols are shown in **Figure 1**. A BJT has a collector, base, and emitter. The base is used to control the current flowing between the emitter and collector.



**Right** ♦  
Transistors come in a range of sizes



**Figure 1** ♦  
Transistor symbols:  
NPN and PNP

Let's look at the NPN (the PNP works the same way except that the polarities and silicon types are reversed). **Figure 2** gives an idea of how the layers look. Thinking back to the diode, it should be clear that this looks a lot like two diodes back to back. Close, but not quite.

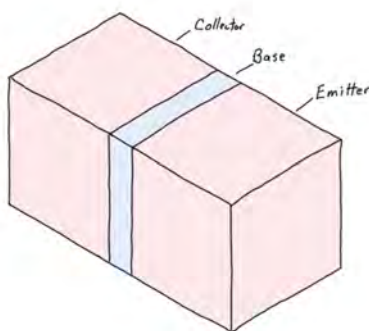
The base-emitter junction does work a lot like a diode. When it's reverse biased, a depletion zone forms, and no current flows and basically nothing is happening (**Figure 3a**, overleaf), just like a diode. When the junction becomes forward biased, the depletion zone collapses and electrons flow from the emitter, across the junction, to the base (**Figure 3b**). Some of them leave through the base connection. But here's the magic: the base layer is so thin, and the electrons are moving with enough energy, that most of them slam through the base layer and go into the collector layer. The result is that the current flowing from emitter to collector is many times greater than the current flowing from

the emitter to the base. Furthermore, as the base-emitter current changes, a corresponding magnified change is made to the collector-emitter current. The effect is that the base-emitter signal is amplified in the collector-emitter current. This amplification factor is typically greater than 100.

### SATURATION POINT

In addition to the signal amplification capabilities, another useful feature of a transistor is its ability to act like an on-off switch. When the B-E junction is reverse biased and the depletion zone is in place, the transistor is in cut-off and acts like an open switch:

**// This is very, very important:**  
all our digital circuitry is  
built on top of this cut-off/  
saturation behaviour **//**



**Figure 2** ♦  
The physical construction of a BJT

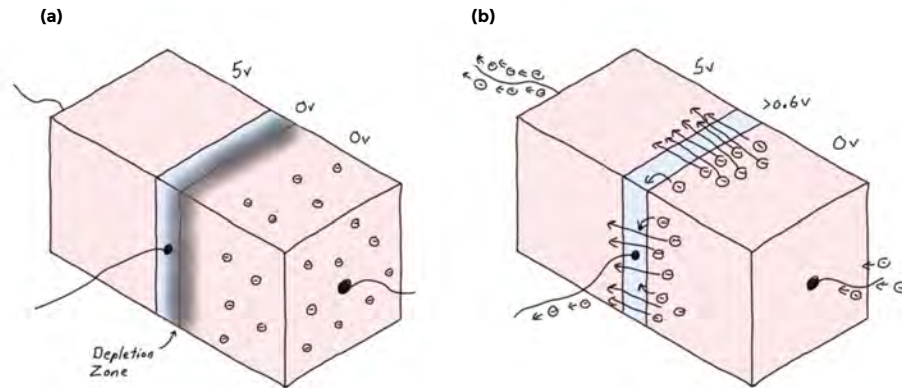
no current flows from emitter to collector. The other extreme is when maximum collector-emitter current is flowing; the transistor is said to be in saturation, and acts like a closed switch. This is very, very important: all our digital circuitry is built on top of this cut-off/saturation behaviour. In addition, this switching behaviour can be used to switch higher voltage/current devices from small signals – like the ones from a 3.3V microcontroller GPIO pin.

As an example, let's use an 2N3904 NPN transistor to control an LED. A typical LED wants 20mA flowing through it. A pretty common microcontroller is the ATSAMD21, which can provide at most 7 mA on an I/O pin. We can use →

### YOU'LL NEED

- ♦ Solderless breadboard
- ♦ 5 V power supply to use with the breadboard
- ♦ 2N3904 transistor (these are often available in packs of five or ten)
- ♦ LED
- ♦ Resistors: 180 or 220 Ω, 2.7 kΩm, and 12 kΩm
- ♦ 3.3 V MCU board
- ♦ TIP120 Darlington driver
- ♦ 12 V, 800 mA LED strip (e.g. part 3865 at Adafruit: Flexible silicone neon-like LED Strip – 1 metre)
- ♦ A 12 V power source for the LED strip (at least 1A)





**Figure 3** ♦ When the B-E junction is reverse biased (a), and when it's forward biased (b)

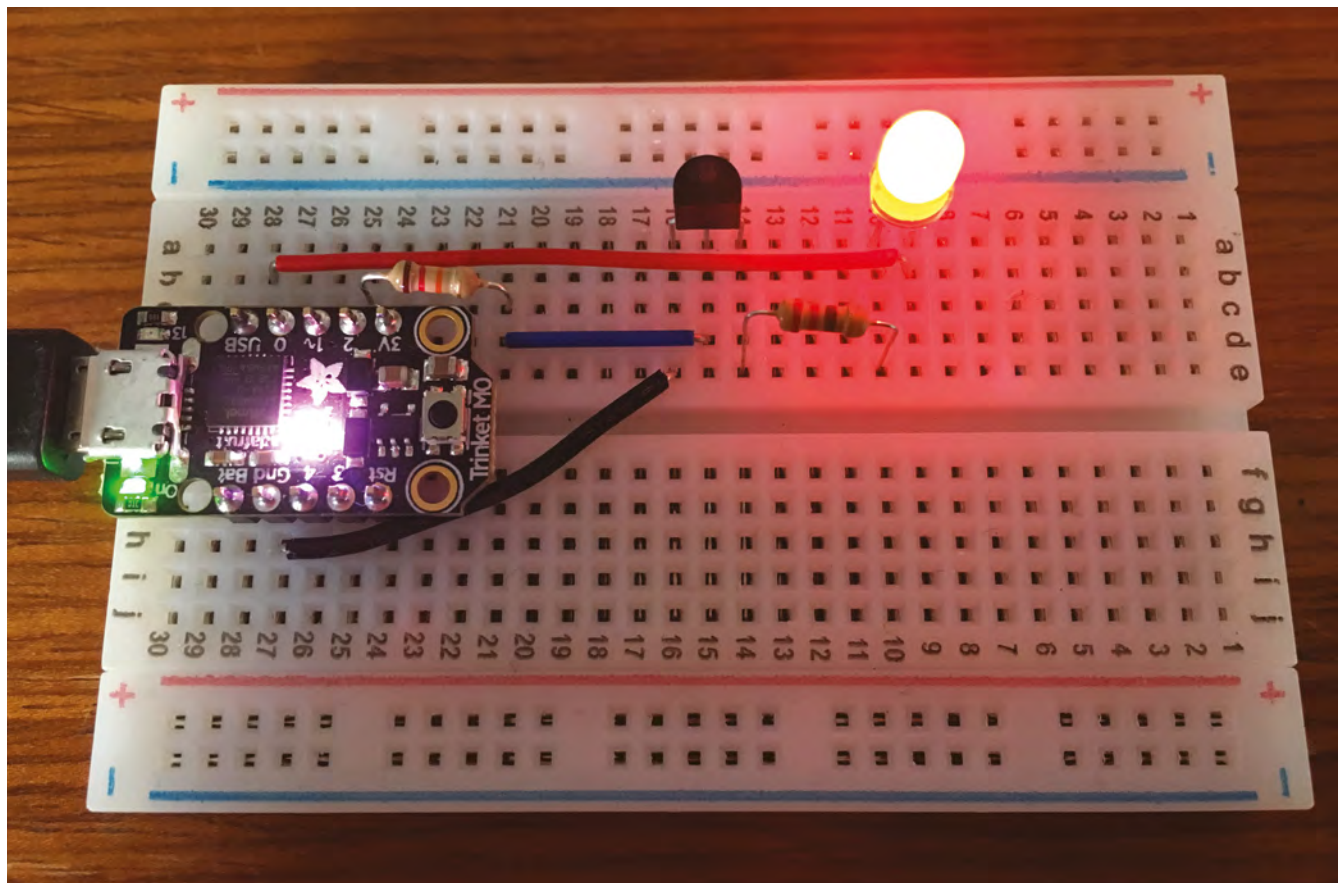
a transistor to control the LED and use the MCU pin to control the transistor. Assuming a typical amplification of 100 by the transistor, we need a base-emitter current of 0.2 mA. With 3.3V on the MCU pin and 0.6V dropped across the base-emitter junction to saturate the transistor, we need a  $2.7V / 0.2\text{ mA} = 13.5\text{ k}\Omega$  resistor between the pin and the base. Slightly less is fine. Much more and the transistor might not saturate. A common value that will do the job is 12 k $\Omega$ . Since the transistor acts as a switch, and assuming we power the LED from 5V (which, in the example circuit, we can pick

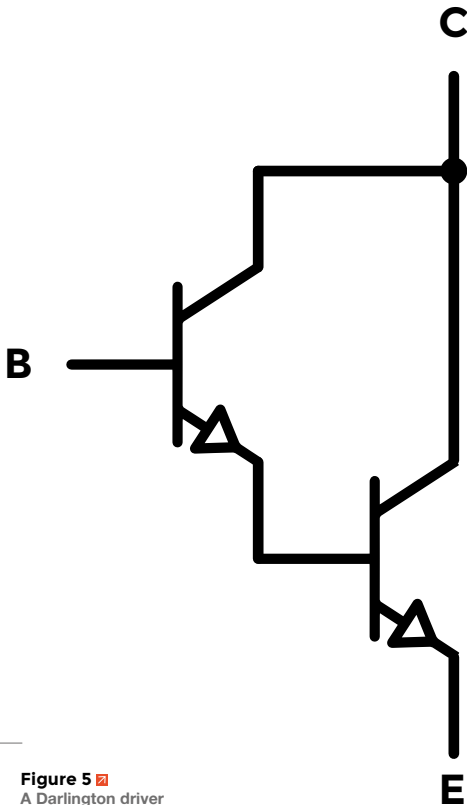
up on the Trinket's USB power pin), we still need a resistor to drop the excess 4.4V to protect the LED:  $4.4V / 20\text{ mA} = 220\Omega$ . This is a common value, so that's perfect. The circuit is shown in **Figure 4**.

**MY DARLINGTON**

We said, above, that a typical transistor will have an amplification of 100 or more. Let's say we wanted to switch 1A of current, maybe for an LED strip. That means we'd need about 10mA flowing through the base-emitter junction to get an amp through the collector-emitter path. Using the ATSAM21 MCU

**Figure 4** ♦ Controlling an LED with a transistor

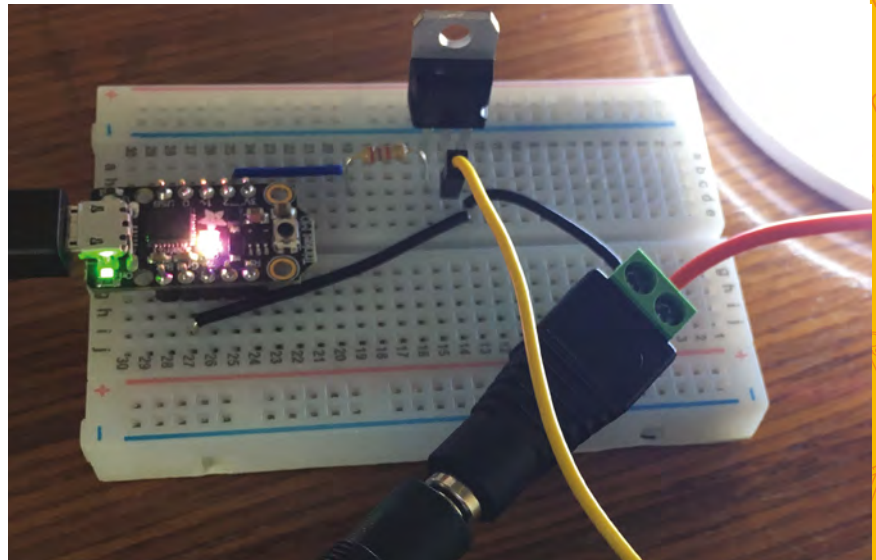




**Figure 5** A Darlington driver

again will not be able to provide the needed current. It turns out that you can cascade transistors, as shown in **Figure 5**. This configuration is called Darlington, and is a pretty common approach to driving large loads from very small control signals. The advantage of this configuration is that the amplification of the individual transistors are multiplied. A typical Darlington is the TIP120, which has a current amplification of about 1000. So using it to switch 1 A means we need a 1 mA control signal. And that will work just fine.

Let's take a look at an LED strip. It needs 800 mA (0.8A) of current to glow nice and bright. Furthermore, it needs 12V. Clearly, you can't just connect it to a 3.3V MCU output pin. So let's use a TIP120 Darlington. Having the separate 12V supply for the LED strip is fine: it presents no problem to the TIP120. You just need to have all the grounds connected. Assuming an amplification factor of 1000, that means base-emitter current has to be 0.8mA. The control voltage from the MCU will be 3.3V and when on, 0.6V will be dropped across the base-emitter junction. That leaves 2.7V to drop across a resistor between the MCU pin and the TIP120 base.  $2.7V / 0.0008 = 3375\Omega$ . We can use a slightly smaller resistor that would give us slightly more than required base-emitter current, which will definitely drive the TIP120



**Figure 6** Switching 12V lights with a 3V microcontroller

into saturation. 2.7 k $\Omega$  is a common value and will work well. **Figure 6** shows the final circuit. Note that the strip is designed to be powered directly with 12V: no external current limiting resistor is needed for this product.

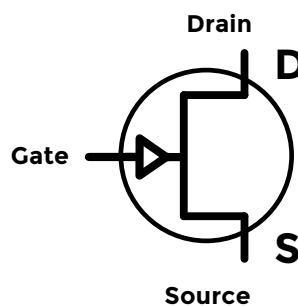
### RUNNING THROUGH FIELDS

The other kind of transistor we mentioned is the FET: field-effect transistor. We'll be talking about the JFET (junction field-effect transistor) specifically. Both the construction and operation of this transistor are quite different than that of the BJT. The schematic symbol and pin names are as well. Let's go from the outside in. **Figure 7** shows the schematic symbols for the JFET. Notice that, like the BJT, there are two types: N-channel and P-channel.

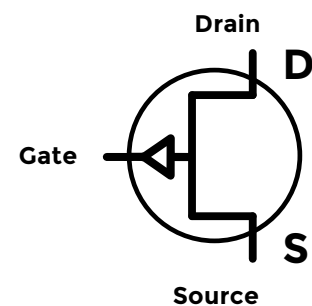
Notice that not only is the symbol different, but so are the pins' names. Instead of collector and emitter, the JFET has drain and source. Electrons enter the source and exit the drain, flowing from the former to the latter inside the transistor. The gate serves as the control over that current. However, it works  $\rightarrow$

**Figure 7** JFET symbols

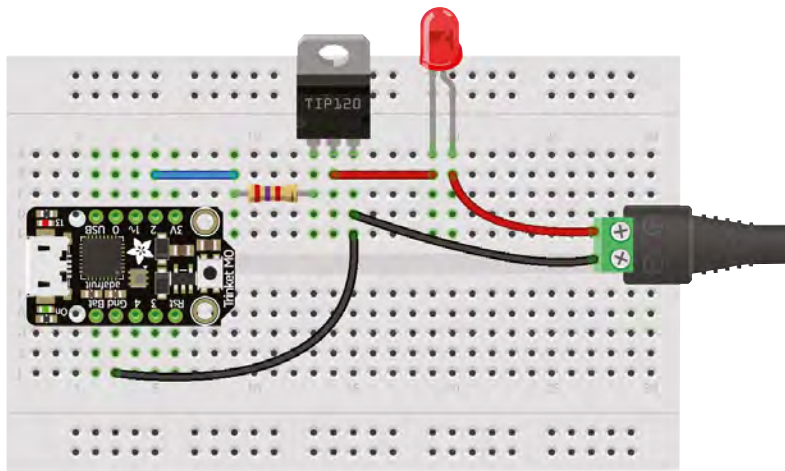
### N-channel JFET



### P-channel JFET

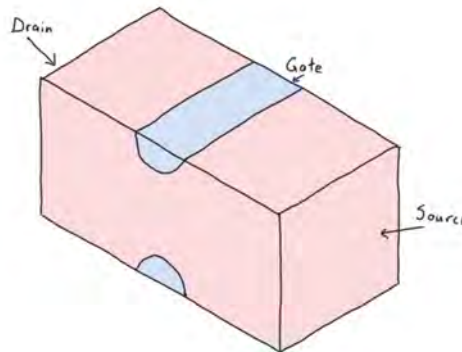






**Above** ♦ The layout of our 12V LED control circuit

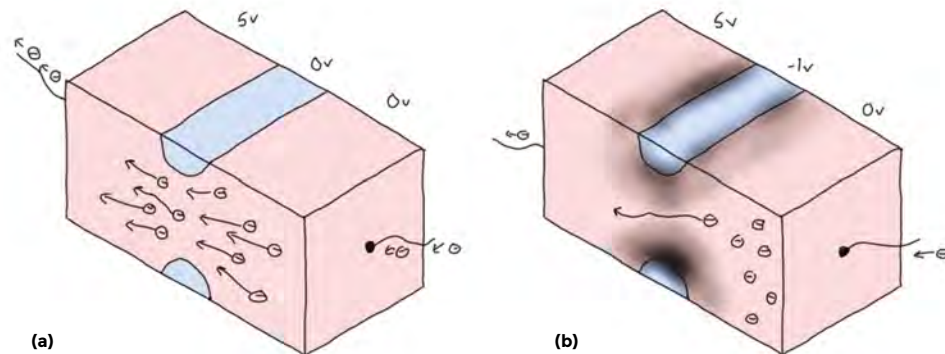
**Figure 8** ♦ Physical structure of a JFET



very differently. **Figure 8** shows the internal construction of an N-channel JFET. As you can see, the source and drain are connected to opposite ends of a single piece of N-type silicon. This is the channel. The gate is connected to a piece of P-type silicon on either side of the channel.

When the gate has no voltage applied to it, the transistor is on and current flows freely between source and drain. When the gate is taken negative with respect to the source, the junction between the gate silicon and the channel is reverse biased and a depletion zone forms around each piece of the gate. This constricts the current flow in the channel. Take

**Figure 9** ■ (a) no voltage on the gate; (b) negative voltage on the gate



**QUICK TIP**

Biasing a transistor means selecting a resistor to use at the base to control the current flowing through the base-emitter junction in order to get the desired current to flow between the collector and emitter.

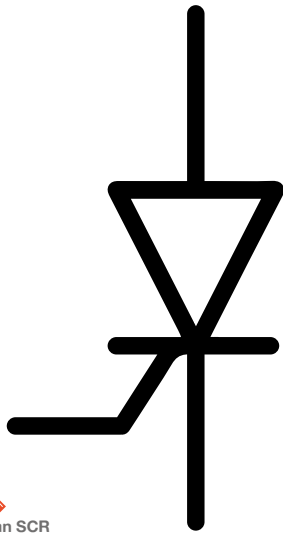
the gate far enough negative and the depletion zone will grow enough to completely cut off the current flow in the channel. See **Figure 9**. A P-channel JFET works the same way but in reverse: the channel is P-type silicon, the gate is N-type, and a positive gate voltage (relative to the source) will turn it off.

There are a couple things to take note of. With no control signal on the gate (relative to the source), the JFET is 'on'; taking the gate negative (again, relative to the source) will turn the JFET 'off'. The other thing is that the JFET is controlled by gate *voltage*, not current like the BJT. This means that the gate is extremely high impedance and has little or no impact on the controlling circuit.

FETs, and especially MOSFETs (metal oxide semiconductor field-effect transistors... that's a big name for a tiny device) in the form of CMOS (complementary metal oxide semiconductor) technology, are the most common form of transistor these days. The majority of integrated circuits are made of MOSFETs of one type or other. They are cheap and easy to make large integrated circuits out of: they are physically simpler so they take up less space, they consume very little power, and over time have become very fast. Of course, new technologies are being invented all the time, so this could change.

**THYRISTORS**

We've seen how transistors can be used as amplifiers and switches. Now we'll turn our attention to some similar components whose only purpose is to be electronic switches: silicon-controlled rectifiers (SCRs) and triacs. We're also going to switch away from looking at the inner workings since these are variations on the BJT. **Figure 10** shows the schematic symbol for an SCR. It does exactly what it looks like from the symbol: it's a controllable diode. When a voltage adequate to forward-bias a base-emitter junction is applied to the gate, the SCR saturates,

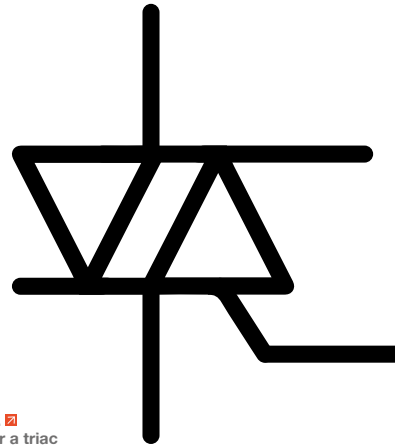


**Figure 10** Symbol for an SCR

switching on. The embedded diode symbol is relevant: when the SCR is on, it acts like a diode.

There are a couple of features that make an SCR especially useful. After it's turned on, it will stay on even if the forward biasing voltage is removed from the gate. That in itself is only partly useful as we would like to be able to turn it off at times. Well, it will turn itself off when the current flowing through it goes to 0. How is this useful? SCRs are often used to control AC devices, like an incandescent light bulb. If you put a pulse into the gate at some point during each positive half of the AC cycle, the SCR will turn on then. When the AC cycle goes back to 0V (hence 0A of current flowing), the SCR will turn off until it's triggered again. That's the basic idea behind a light dimmer. **Figure 11** shows the waveforms: full AC at the top, trigger, and the controlled wave at the bottom.

A problem with the SCR is that it is, at its heart, a diode. If we use it as above, we are throwing away half of the available power. The most power the load can use is half of what's available. If this is



**Figure 12** Symbol for a triac

a problem, there is related component that we can turn to: the triac. A triac is like a bidirectional SCR. It will let current flow in either direction, turning on with a gate signal the same as an SCR, and turning off when current through it drops to 0 – again, like an SCR. In fact, you can think of a triac as being two SCRs in parallel, pointing in opposite directions, sharing a common gate signal. The schematic symbol is shown in **Figure 12**.

If we generate a trigger pulse during each half of the AC wave, we get waveforms as shown in **Figure 13**. Now we can vary the output power from 0 to 100% rather than 0 to 50%.

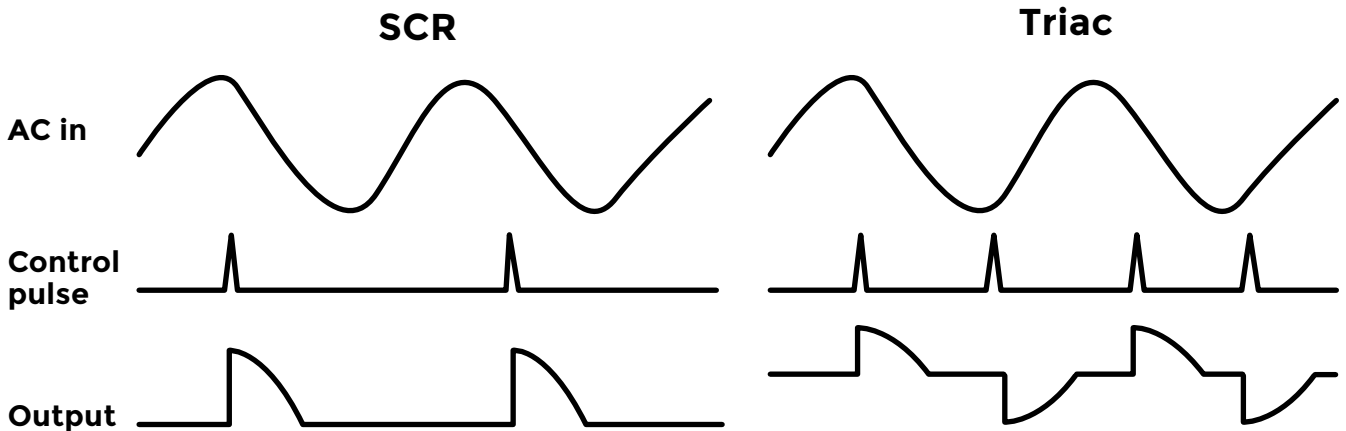
We'll be making use of SCRs and triacs later in the series.

Transistors, the heart of modern technology, are actually quite simple, as we've seen. What's not so simple is the range of circuits that we can make with them. We'll start looking at some of those in the next instalment.

That's right, now that we've covered the various concepts and components, we'll start digging into more complex applications of them and building some projects. So, get out your breadboards and stock up on some basic components.

**Figure 11** SCR waveforms: input AC, trigger, controlled

**Figure 13** Triac waveforms: input AC, trigger, controlled







# Maker's Toolbox: Screwdrivers

There's more to this tool than meets the eye



**Above** ♦  
The Wera screwdriver includes a rotating cuff that lets you hold the tool securely as you turn it



**Ben Everard**

🐦 @ben\_everard

Ben loves cutting stuff, any stuff. There's no longer a shelf to store these tools on (it's now two shelves), and the door's in danger.

**H**ere in the UK, the two most common types of screw are ones with a single, straight cut through the head, and those with a cross cut into the head. They're commonly known as flat-head, and Phillips.

Unfortunately, both these names are wrong. The former is a slotted-head (a flat head refers to the shape of the screw head that can finish flush with the surface, regardless of drive type); while the latter may be Phillips, it's more likely to be Pozidriv.

Phillips and Pozidriv both have a cross-shaped hole in the head, but it's important to understand the differences. When using a screw, the biggest problem is camming out. This is where the force on the screw causes the driver to pop out, often damaging the screw or driver in the process. When it happens too many times, the screw can be worn to the point where it's hard to remove.

There's speculation that Phillips may have been designed to cam out at a particular force, as this would be useful in assembly as a sort of primitive clutch, to prevent screws from being driven with

too much force and stripping the thread. There's not much evidence that this is true, but it certainly is the case that Phillips screws have a tendency to cam out at much lower forces than other screw heads.

While a Pozidriv screwdriver looks similar to Phillips, the design of the crossed blades in the bit is subtly different, and this means it's much less likely to cam out (but will if too much force is applied).

You can fit a Pozidriv bit in a Phillips screw and vice versa, but you really shouldn't. The result will be a cam out at a low force, and therefore a much greater chance of destroying the screw head. Fortunately, it's easy to tell the difference between the two, as Pozidriv screws should have an additional X marked at 45 degrees to the main drive slots.

While Pozidriv allows you to apply more torque than Phillips, if you need more then you might want to consider a hex (aka Allen) or Torx (star-shaped) screw. However, these are more common on bolts than screws.

Picking the perfect screw is a complex question where there's scope for personal preference,



**Above** ♦ Pozidriv (top) and Phillips (bottom) look similar, but you'll have problems if you use the wrong driver for a screw

geographic location, and the intricacies of the particular project. However, if you need a rule of thumb: use Pozidriv, unless there's a good reason not to. Our American friends might not find Pozidriv screws as easily as those of us in Europe, but they're worth seeking out if possible. Slotted heads have no way of easily keeping the driver central, and Phillips cam out too often. Torx can work well, but the screws aren't common.

## DRIVE ON

As the screwdriver gets worn by camming out, it becomes more prone to camming out, and so you descend down a slippery slope of stripped screws, jammed joints, and anguish. Getting screws in and out safely starts with the right screwdriver. There are two parts to this. Firstly, you need to make sure you've got the correct types and sizes for your screws. Secondly, you need to make sure they're strong enough to cope with repeated use.

The traditional screwdriver is a single tool for driving one type and size of bit. Alternatively, you can get sets where you can change the bits in a single handle. The former is often easier to work with if you use a limited range of screws, while the latter is often better if you need a wide range of different types. Of course, it comes down to personal preference as well.

It's also common to use driver bits in electric drills, but bear in mind that these can produce significantly more torque than the bits can handle, so make sure you set the clutch before starting, or you'll damage both bit and screw.

## ON TEST

Screwdrivers span a huge range of prices. At the low end, you can get driver sets for just a couple of pounds; however, you can also pay over £100 for a good set. We tested out a Wera Tool-Check Plus

## OH! CANADA!

Our Canadian readers might be wondering why we've missed out the most popular screw in Canada: the square, or Robertson, head. It's a great screw design that's not prone to camming out but, due to a history that's got more to do with patent law than technical merit, it never caught on elsewhere.

set, to see what you can get for £75.49. You get a set of interchangeable bits covering the most common slotted, Phillips, Pozidriv, hex, and Torx bits (and two of some to keep you running when one wears out). The holder spin sleeve allows you to keep the driver steady with your non-turning hand, and also locks in the bits (though we've rarely had problems with the bits falling out of the handle).

This isn't an enormous kit, so if you're working with a lot of exotic equipment, you might find it lacking. However, we found it complete enough for most screws in our workshop. There's also a ratchet and socket set, but those aren't relevant to screws.

Perhaps the main thing you pay for is the toughness of the bits. The bits in this kit are made of chrome-moly steel that should keep them going for a long time.

The advantage of a tough screwdriver isn't that you don't have to replace it as often (though that is an advantage), it's that it does less damage to the screws. Worn screwdrivers wear down screw heads, and this means that with a quality screwdriver you're less likely to end up with stripped screws stuck in things you're making, and this means fewer headaches.

It can be tempting to buy cheap screwdrivers, but if you're a maker you're probably going to be regularly using screwdrivers for some time, and a good set can be a great investment. The Wera Tool-Check Plus is a good option that should last for many years. □

**Below** □ The Wera Tool-Check Plus will work with all common screw types and folds down into an easy-to-transport pack





# Knife switch

Safely awaken a monster, or just turn on a light, with this remote-control knife switch



Andy Clark

workshopshed

For the last ten years, Andy has been making and repairing in a shed at the bottom of the garden. You can see more of his exploits at [workshopshed.com](http://workshopshed.com)

**T**he knife switch is often seen in classic science-fiction films. But the charm of its simple design is also its major flaw: it can't be safely used to switch on high-voltage circuits.

Typically, a mad scientist would pull the lever and sparks would fly as the circuit is connected. We wanted to replicate that but in a safe manner, so we repurposed a Raspberry Pi remote-control socket and added some special effects.

## SWITCHGEAR

The knife switch is a double-pole, single-throw switch. It can connect two circuits in parallel. The name comes from the action of the two

lever arms that slot between the contacts in a cutting-like action.

The main parts are made from brass, which is a good conductor and easy to work. The connecting handle between the lever arms needs to be an insulator so the two halves of the switch don't join. This part is 3D-printed, and either ABS or PLA should work fine for this part. The base also needs to be an insulator, so we used a 3mm clear sheet, made of polycarbonate or acrylic.

The arms are made from thicker 2mm brass strip; this will stop them flexing in use. First, cut them to length. Drill a hole in one end to match your pivot bolt. Drill and tap a hole in the other end for the handle mounting screw. Round the ends with a file.

The hinge contacts require three holes: the first matches the pivots in the arms, the second is used to attach the arms to the case, and the last is for a bolt for the electrical contact. Drill these first, and then mount both in the vice and bend them at 90°.

The contacts are made from a thinner brass strip. Drill the holes for the mounting bolts and contact first. Then, fold the tight bend for the contacts using a nail or rod as a former. Fold the upper contact at 90 degrees. Fold the lower contact, bearing in mind that this fold is in the opposite direction and one thickness further along the bar. Place the upper contact on top of the lower contact, and check that the tops of the two contacts are level.

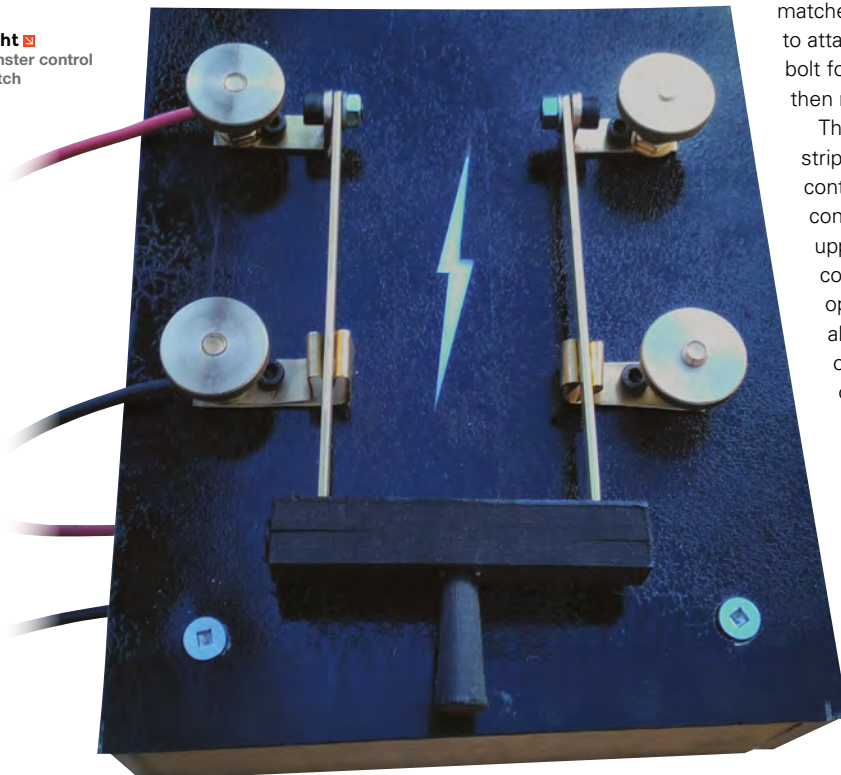
## PLASTIC AND WOOD

The handle is printed from a black plastic, and PLA or ABS should be fine. We used recycled ABS that used to be car dashboards. Printing the cross piece without supports should work fine.

The knob is best printed with supports, and sanded smooth. Glue these parts together with suitable plastic adhesive.

The backboard for the switch is a piece of clear plastic. Drill the

**Right** Monster control switch



## SHIFTING PLATFORMS

Many Raspberry Pi boards can be used without a Pi. Check sites such as [pinout.xyz](http://pinout.xyz) to see their connections. Key features to look for are the number of GPIO pins used, voltage levels, and the protocol used to talk to the board. The software for Pi boards is often open source, so you can port it to other platforms. A circuit called a level-shifter can be used if your logic signals are different voltages to the board.

mounting holes for the hinges and contacts, then drill the four corner holes for mounting to the back frame. The rest of the case is made from four strips of wood, with blocks in the corners. Make the top pieces the full width of the plastic, as this is most visible. The side pieces will be the length of the size, minus two times the thickness of the wood you are using. Drill holes in the side for the contact wires.

Use masking tape to mark the electrical spark symbol and to mask the back of these holes. Spray the board with gloss black paint. One or two coats should be sufficient. Once this is dry, remove the tape.

Drill and screw the backboard to the wooden frame.

### CODE FOR SPARKS

For the electronics and control software, we can use parts that others have created. The Pi-mote is a small board designed to be used with a Raspberry Pi. It takes a 4-bit encoded signal to turn on one of four remote sockets via a simple radio. Jiri Dohnalek has

“ The connecting handle between the lever arms needs to be an insulator so the two halves of the switch don't join ”

produced an Arduino library for this board, so we can use that as a basis of the code. We use an interrupt to trigger the switch being changed.

The first part of the code is to include the library for the Pi-mote. You will need to copy the files from Jiri's GitHub repo – [hsmag.cc/hKgmOs](https://github.com/hsmag/cc/hKgmOs) – into the same folder as your project.

A variable for the socket object is created to allow us to interact with the remote control hardware. We use a variable to store if the interrupt has been

triggered. This variable is set to volatile so that the compiler knows that this variable is changed by the interrupt. We also declare a variable to store the current state of the switch.

```
#include <Pimote.h>
Pimote socket;
byte buttonState = 0;
volatile byte triggered = 0;
```

The setup configures pin 2 as an input, with 3 and 4 as outputs. It also sets up an interrupt which causes code to run when the signal changes on pin 2. This function is called an interrupt handler, or interrupt service routine. The lines for the socket define which pins are to be used and enable the hardware. →

Below  
Hinges





### YOU'LL NEED

- ◆ **Brass strip**  
2 mm and 1 mm
- ◆ **Brass nuts and bolts**
- ◆ **5 mm socket head screws**
- ◆ **Black ABS or PLA filament**
- ◆ **Clear plastic sheet**  
3 mm
- ◆ **Wood or MDF**
- ◆ **Black paint**
- ◆ **3.3 V Arduino**
- ◆ **Batteries / PSU**
- ◆ **LED backlight**
- ◆ **100 Ω resistor**
- ◆ **Piezo buzzer**
- ◆ **Energenie Pi-mote Control**
- ◆ **2 × 20-pin Raspberry Pi header**



```
void setup()
{
  pinMode(2, INPUT_PULLUP);
  pinMode(3, OUTPUT);
  pinMode(4, OUTPUT);
  attachInterrupt(digitalPinToInterrupt(2),
    switchChange, CHANGE);

  socket.setESD0(A0); // set Encoded Signal D0
  socket.setESD1(A1); // set Encoder Signal D1
  socket.setESD2(A2); // set Encoder Signal D2
  socket.setESD3(A3); // set Encoder Signal D3
  socket.setMODESEL(A4); // set MODESEL mode select
  signal (OOK/FSK)
  socket.setCE(A5); // set CE modular enable
  (Output ON/OFF)

  socket.begin();
}
```

The interrupt handler is kept simple, as no other code can be running while the interrupt is run. We set the flag to indicate that the interrupt was triggered.

```
void switchChange() {
  triggered = 1;
}
```

The main loop of the code checks to see if the interrupt was triggered. The short delay gives the switch time to settle. It then activates the LED backlight and buzzer. The state of the switch is toggled and sent to the Pi-mote.

```
void loop()
{
  if (triggered == 1) {
    delay(5);
    buttonState = digitalRead(2);
  }
}
```



**Above** ▣  
Leave a gap big enough for the bar

**Right** ◆  
Print separately and glue together

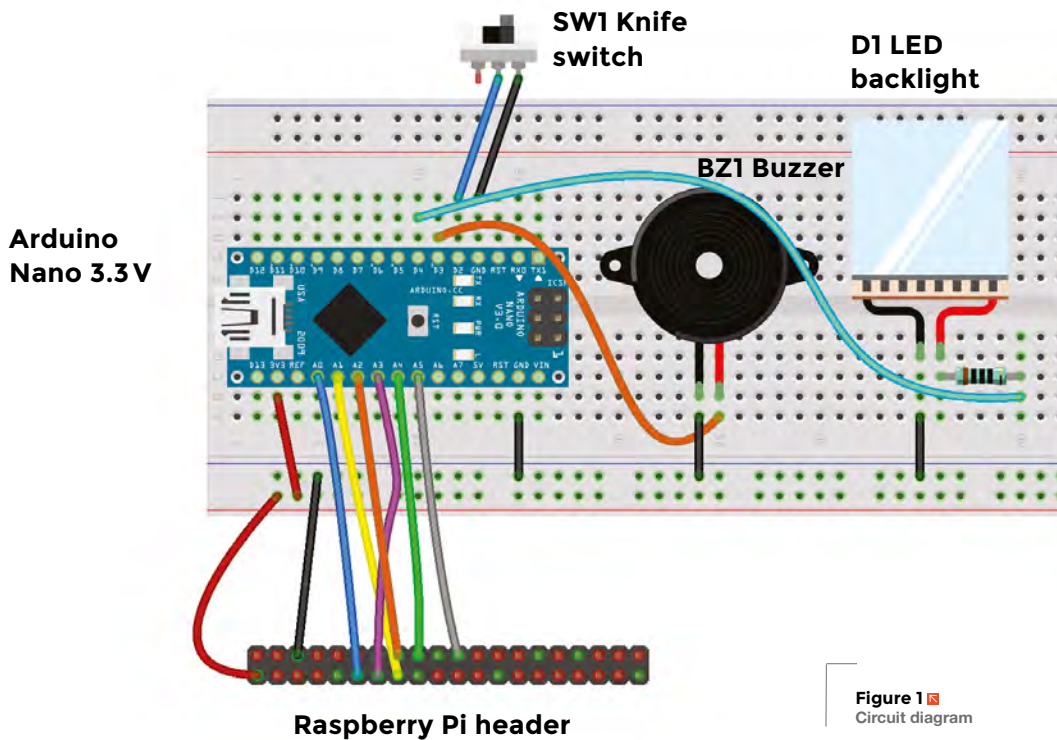


Figure 1  
Circuit diagram

## BOUNCY BOUNCY

When a mechanical switch's contacts close, they can bounce, causing the signal to rapidly turn on and off. Turning this into a clean on/off signal is called 'debouncing'. Debouncing can be done with electronics such as a low-pass filter, or in code with a delay.

```
arc();
if (buttonState == 1) {
    socket.on(1);
} else {
    socket.off(1);
}
triggered = 0;
}
```

The purpose of the `arc` function is to simulate an arcing contact. It does that by flickering the backlight on pin 4 and sending tones to the buzzer on pin 3. The tone frequency is incremented by the square of the loop counter `i` to give a sound similar to a Jacob's ladder.

```
void arc() {
    for (int i = 0; i < 100; i++) {
        int o = random(2); // Random number from 0 to 1
        digitalWrite(4,o);
        float t = ((float)i*(float)i)/1000 + 120;
        tone(3, t ,4);
        delay(5);
    }
    digitalWrite(4,buttonState);
}
```

### COMPLETING THE CIRCUIT

The electronics for the project consist of the Arduino, a phone backlight, a buzzer, the Pi-mote board, and

“ The electronics for the project consist of the Arduino, a phone backlight, a buzzer, the Pi-mote board, and the knife switch ”

the knife switch. Connect the hinge terminal of the switch to ground, then connect the contacts to pin 2. As the switch is symmetrical, you can connect either side.

Connect one contact for the buzzer to ground and the other to pin 3. The backlight requires a series resistor to limit the current; we used a 100Ω resistor. Connect this to pin 4 and to the backlight's anode; connect the cathode to ground. Then, connect the pins to the Raspberry Pi header, as in **Figure 1**. □

## OTHER IDEAS

There are loads of ways you could alter this project to make it your own. A few of our favourites are:

- Use the Arduino sleep modes to put the board to sleep between triggering and improve battery life
- Add a smoke generator
- Add an MP3 of manic laughter
- Create an ultra-modern version with big push-buttons

## QUICK TIP

When you have many connectors going to one terminal, such as ground, a busbar will make assembly easier.



£12.99  
200 pages of  
Raspberry Pi

THE *Official*

# RASPBERRY PI PROJECTS BOOK

VOLUME 4

Amazing hacking  
& making projects

from the creators of

*The MagPi* magazine

Inside:

- How to get started coding on Raspberry Pi
- The most inspirational community projects
- Essential tutorials, guides, and ideas
- Expert reviews and buying advice

Available Now

**FREE  
DELIVERY**

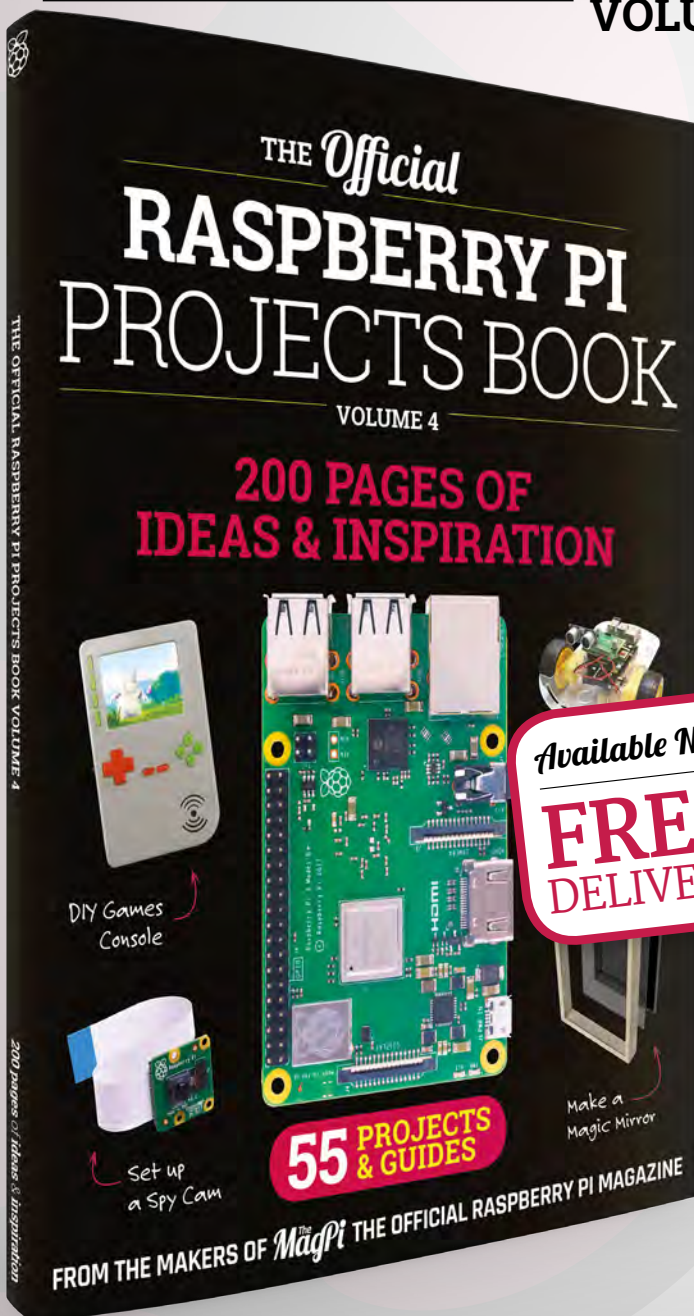
[store.rpiexpress.cc](http://store.rpiexpress.cc)

plus all good newsagents and:

WHSmith **BARNES & NOBLE**

Available on the  
 App Store

GET IT ON  
 Google Play



NEW

# Wireframe

Join us as we lift the lid  
on video games



Visit [wfmag.cc](http://wfmag.cc) to learn more




# NFC data cuff-links

Covert data carriers for geeks and secret agents



Sophy Wong

 @sophywong

Sophy Wong is a designer, maker, and avid creator. Her projects range from period costumes to Arduino-driven wearable tech. She can be found on her YouTube channel and at [sophywong.com](http://sophywong.com)

**H**ave you got a fancy event to attend and need a cool accessory for your outfit that you can store about 144 bytes of data in? We've got you covered! In this project, we'll make a pair of NFC data cuff-links, ideal

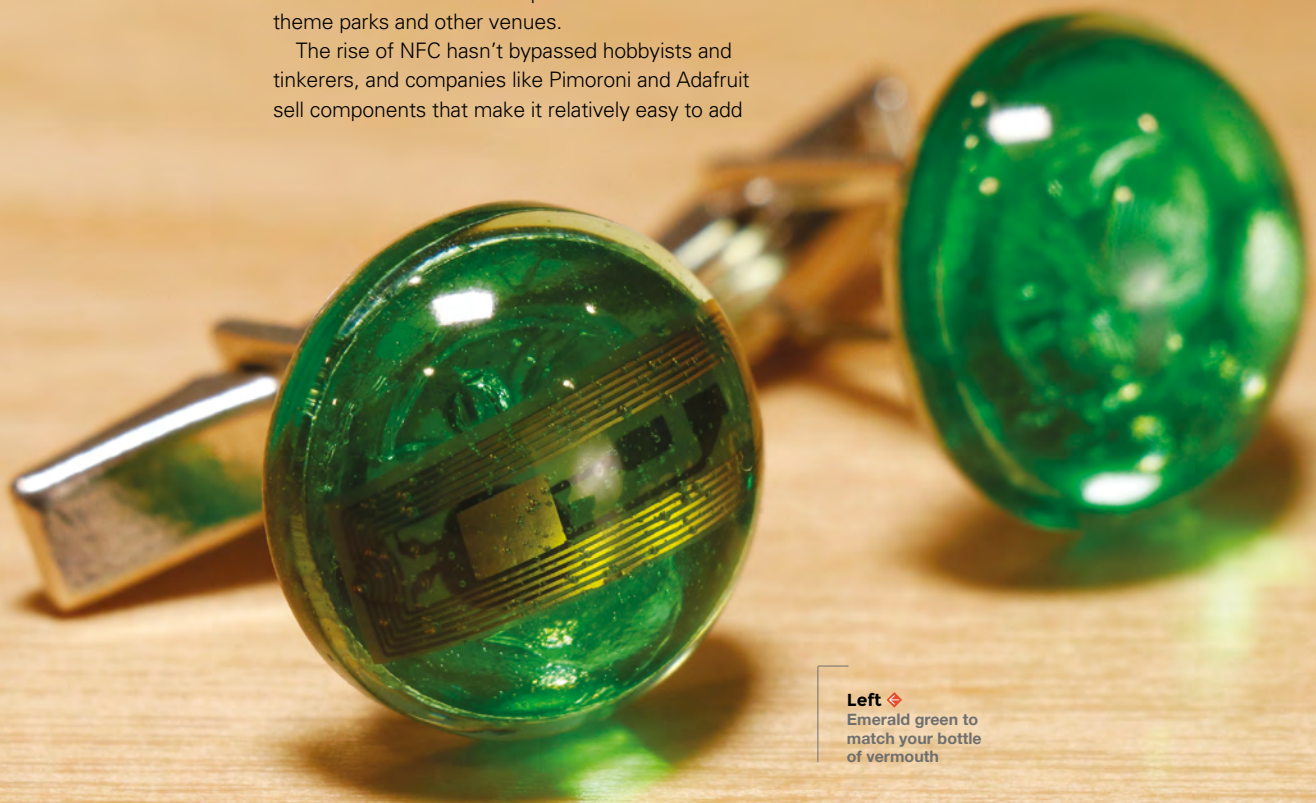
for storing a website URL, a password, or a secret message. This project is perfect for a sartorial spy who loves dry Martinis, and anyone who can't remember their WiFi password.


NFC stands for near-field communication, and is a protocol that allows two devices to communicate wirelessly when they are physically near each other. An evolution of RFID, NFC is becoming increasingly popular in consumer technology, and is already commonly used in contactless payment systems and identification badges. NFC wristbands are also being used to create enhanced experiences for visitors at theme parks and other venues.

The rise of NFC hasn't bypassed hobbyists and tinkerers, and companies like Pimoroni and Adafruit sell components that make it relatively easy to add

NFC functionality to your projects. Here, we'll make use of tiny NFC tags that can be read and written to by a smartphone or external NFC reader. The tags can be read through a non-metal barrier, like plastic, so we'll embed the tag in resin to make an elegant cabochon for our cuff-link. When complete, holding the cuff-link to your smartphone or NFC reader will let you read or write data to the chip inside.

For this project we used the smallest NFC tags we could find, micro NFC/RFID transponders from Adafruit (product number 2800). These 15.6mm x 6mm flexible tags are formatted with the now standard NDEF format, and will work as-is with newer phones and most NFC readers. If you happen to pick up older Mifare Classic formatted tags, they may need to be reformatted as NDEF to work with your reader/writer. Reformatting isn't a function of most NFC read/write



**Left**   
Emerald green to match your bottle of vermouth

apps, but it can be done with Adafruit's PN532 NFC/RFID controller breakout board or shield.

If this is your first time working with resin epoxy, get ready for a new, fun kind of mess! Resin epoxy comes in two parts that must be mixed together in equal proportions before use. Once mixed, the resin will be workable for a short period of time before entering the curing phase and hardening completely. Figuring out exactly how much resin to mix up is definitely an



**// You'll end up with more than two cabochons... if you're going to make a mess anyway, why not go big? //**

art. There are even some online tools available to help calculate this. For a small project like this, just make sure you mix up a bit more than you think you'll need. You don't want to run out during the pour and have to quickly mix up more at the last minute. If you're tinting your resin, you definitely want to pour all of your pieces from the same mix, as it's almost impossible to match the colour of one batch of resin to another.

All of this means you'll undoubtedly end up with more than just two cabochons for one pair of cuff-links,

and if you're going to make a mess anyway, why not go big? Pick up a few extra NFC tags and plan to pour some other pieces, like pendants or key chain fobs. These make great holiday or birthday gifts that are both technologically advanced and crafty at the same time!

Resin-cast jewellery has been made for decades and there are loads of options for resin moulds available at craft stores and online. The best moulds for resin are made of silicone. Flexible silicone moulds make it easy to remove the hardened pieces, and produce ultra-shiny surfaces. Cuff-link blanks, ring blanks, and pendant bails can also be purchased at jewellery supply stores. Refer to your moulds when choosing cuff-link →

**Above** ♦ Just make sure you don't break them on your first mission

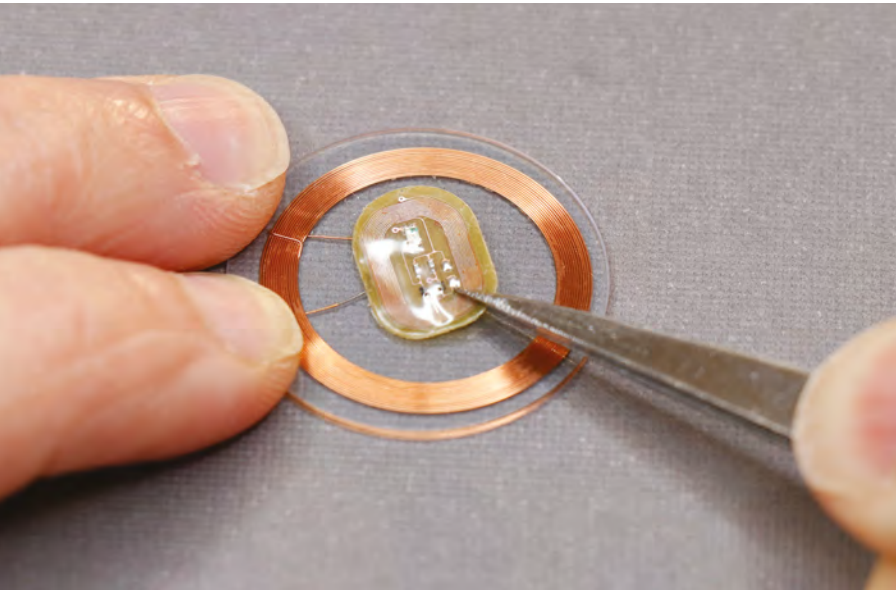
**Below** ▣ Resin: tough, transparent, and easy to work with



- YOU'LL NEED**
- ♦ Micro NFC/RFID transponders
  - ♦ NFC-capable phone or USB NFC reader/writer and computer
  - ♦ Clear casting two-part resin epoxy
  - ♦ Resin tints for adding colour
  - ♦ Small measuring/mixing cups
  - ♦ Stirring sticks
  - ♦ Tweezers
  - ♦ Cabochon moulds for jewellery making
  - ♦ Cuff-link blanks
  - ♦ Isopropyl alcohol in a fine mist spray bottle
  - ♦ E6000 adhesive
  - ♦ Safety gear: nitrile gloves, particle mask, respirator



## TUTORIAL



it hardens, so planning and timing is key. Check the 'pot life' indicated on your resin; this is the amount of working time you'll have after mixing before the resin begins to harden. Our resin had a pot life of 30 minutes. It can be helpful to set up a timer so you can keep track of time while you work.

If you have multiple moulds, decide which ones you will use before mixing, and make sure your NFC tags will fit into the shapes you plan to use. If you are making matching cuff-links, remember that you'll need two identical shapes. Our tiny 15.6mm tags fit perfectly into 16mm cabochons. Remember that you will mix more resin than you need for just two cuff-link cabochons, so it's good to have extra moulds in front of you to pour into.

### PREPARE THE NFC TAGS

Unwrap the NFC tags and make sure they are clean and ready to be embedded in the resin. For a light-up effect, you may want to combine a data tag with an LED tag, like we did in one of our extra pieces. The back of the NFC LED nail sticker is adhesive, so it was easy to stick it directly to the larger data tag.

### MEASURE, MIX, AND POUR

We mixed up about 6oz (170g) of resin, then tinted it green for a tech-emerald look. This was plenty for two cabochons and three to four extra shapes.

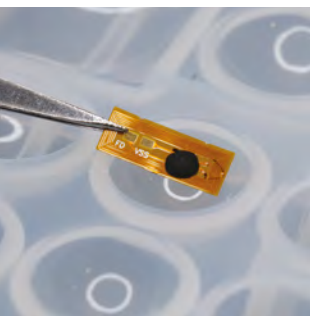
Follow the manufacturer's instructions to mix up your resin. Generally, it's a 1:1 ratio by volume. A good method for this is to pour each part into matching containers, up to the same measuring mark. Then, pour both into a third cup and stir. Stir slowly, but thoroughly, for at least two or three minutes, making

and ring blanks, to make sure that the blanks will work with the size of cabochon you've chosen to cast, and vice versa.

### LICENCE TO SPILL

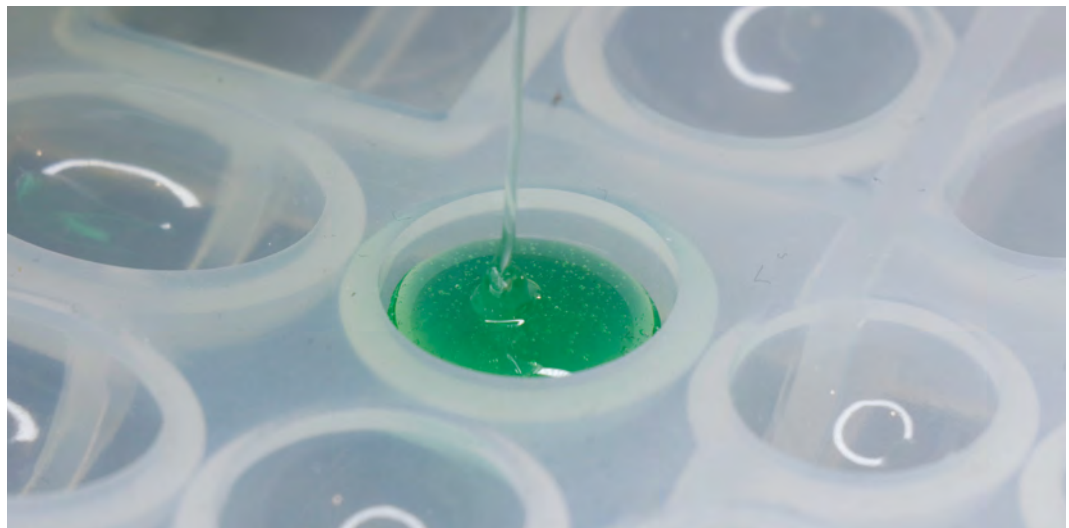
Start by gathering your materials and setting up your workspace for working with resin. There will be a lot of stirring, pouring, and drips, and things are likely to get messy! Cover your work surface with paper and keep some paper towels nearby. Read and heed the safety warnings on your resin and hardener. Although some resins are considered non-toxic when used as directed, it's always a good idea to work in a well-ventilated area and wear nitrile gloves to keep the resin off of your skin while working.

Once the two-part resin is mixed together, you will have a limited amount of time to pour the resin before

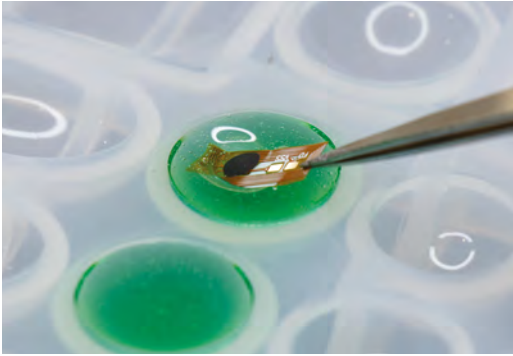


**Top** Tiny tags can be hard to work with, so be careful

**Above** Make sure your tag fits in your mould



**Right** Pour gently, and take your time



**Left** ♦ Long, thin moulds will fit the tags more easily

**Above** ♦ Gently does it! A delicate touch is needed

sure to scrape the sides of your mixing cup often. If the resin is not completely and evenly mixed, it will not cure properly. If tinting your resin, add the tint to your mixed resin one drop at a time, slowly deepening the colour to your preference.

Once your resin is mixed and tinted, you'll notice lots of tiny bubbles that have been incorporated while you were stirring. Let the mixture rest for a few minutes so the bubbles can float to the top, then use a stick to move the bubbles to the side of your container and pop them.

When you've removed as many bubbles as possible, it's time to pour! Place your moulds on a level surface where they'll be able to sit undisturbed for the amount of time required to cure (check the manufacturer's instructions; ours specified 24 hours curing time). Pour the resin in a thin stream into the deepest point of your mould, and let it slowly rise to just below the top lip of your mould. Don't overfill the mould, or the resin will

bow and have a convex bottom when you remove it from the mould. Pouring the resin in a thin stream can help pop larger bubbles that are still in the mix.

### EMBED THE NFC TAG

With the resin in your mould, you can slide the NFC tag into place. Using tweezers, dip the tag into your unpoured resin to coat it first – this will help the resin in your mould accept the tag without adding too many bubbles. Then, gently slide the tag into the mould and centre it in the resin. It will want to slowly sink to the bottom of the mould, and ideally it stays centred on the way down. You may need to wiggle it back into place with your tweezers or a thin stick, but try not to introduce any new bubbles.

After your resin is poured and the NFC tags are in place, let the resin sit in the moulds for about ten minutes. This is enough time for most of the bubbles to rise to the top surface. Then, spray a fine mist of isopropyl alcohol over the resin to pop the bubbles. This step is optional, but we noticed that it really helped achieve clearer results. →



**Left** ♦ Clear and shiny!

**Below** ♦ You don't have to embed tags – you can pour some clear





## TUTORIAL

**Right**  Larger moulds can be used for decorative items



**//** You could also glue the cabochons to ring blanks to make NFC data rings

**//**

Repeat this process for all the moulds you want to pour and add NFC tags to. Check them after a few minutes to make sure your tag hasn't slid out of place, and remember to keep an eye on your pot life timer. Finish all your fiddling and bubble popping before the resin starts to harden. Then, leave your resin to cure for the amount of time specified in your resin's instructions.

### DEMOULD YOUR RESIN PIECES

When the resin has completely hardened, it's time for the exciting part: removing the cured resin from the moulds. If using silicone moulds, your piece should release from the mould without much fuss. Gently flex the silicone to let air seep between the hardened resin and the wall of the mould. Then you should be able to carefully pull the resin piece out of the mould.

Take a moment to admire your shiny cabochons! If you discover that you've over-poured your moulds, or the resin has crept up the sides of the mould, making a curved back, don't worry. Resin can be wet-sanded; just be sure to keep both the sandpaper and the piece under water while sanding, and wear a mask to keep from inhaling resin particles.

### MAKE THE CUFF-LINKS

Use glue to affix the flat-backed cabochons to the cuff-link blanks. We used E6000, which is

an industrial-strength adhesive that works great on plastics. Again, be sure to work in a well-ventilated area, and wear a respirator while working with E6000.


Apply the glue to the cuff-link blank and hold the cabochon in place while the glue sets. Make two, and you're done! You could also glue the cabochons to ring blanks to make NFC data rings. For pendants, you can use jewellery findings like bails and jump rings to make necklaces or key-chain fobs.

### PROGRAM THE NFC TAG

Now that you've made your NFC cuff-links, you can load them with data like a website, a password, or a secret message. There are a few methods for doing this.

If you have an NFC-capable smartphone, such as an Android phone, you won't need any additional hardware. You can download a free app like NFC Tools to write and read data on your cuff-link. NFC



**Right**  Be creative when selecting your moulds



**Above** ♦  
An even layer of glue helps the stone stick

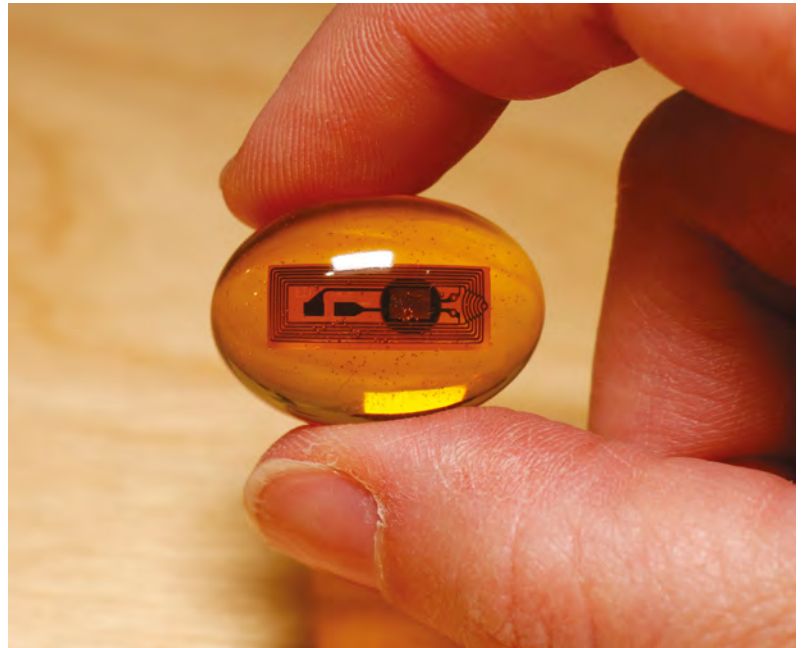
Tasks, another free app, lets you create automatic actions for your phone to perform when the NFC tag is read.

If you have an iPhone, (at the time of publishing of this article) you cannot write directly to NFC tags from your phone. But don't worry! You can still join the NFC fun by purchasing a USB NFC reader/writer. You'll be able to read and write to NFC tags with your computer using the NFC Tools desktop app. Your author purchased the NFC reader/writer shown here for about \$35 on [Amazon.com](https://www.amazon.com).

You can still use NFC Tools on your iPhone to read tags, and the latest version of iOS, 12.1, supports background NFC tag reading. Some basic actions, like opening a URL in a browser, can now be performed right from the home screen or lock screen – pretty cool!

For a more custom hardware/software approach, try Adafruit's PN532 NFC/RFID controller breakout board, which lets you add NFC functionality to Raspberry Pi or Arduino projects. It takes some

**Below** ♦  
Most modern phones can detect NFC tags



**Above** ♦  
Technology meets art

**Below** ♦  
What your tag does is up to you

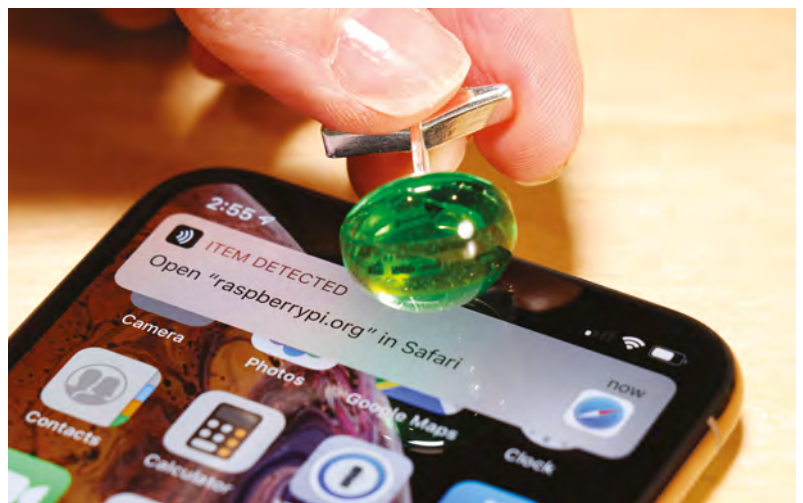
soldering and programming to set up, but this breakout gives you lower-level control of the NFC tag, and is supported by an Adafruit NFC Arduino library. The library includes handy example code for reading and writing to tags, and reformatting Mifare Classic tags with the NDEF format.

### ON HER MAJESTY'S I.T. DEPARTMENT

Sport your new cuff-links at your next dressy event, and you'll be both covert and classy! Or, gift these to your favourite snappy dresser, loaded with a secret message for their eyes only. Heading to a conference? Instead of handing out a business card to connect with someone, hold your wrist over their smartphone to bring up your webpage. It's not magic, it's technology! □

### GET IN TOUCH

Working on a cool NFC project? Show us at [hackspace@raspberrypi.org](mailto:hackspace@raspberrypi.org)





# Maker's Lab: Play-dough circuits

We investigate doughs for electronics



Ben Everard

[@ben\\_everard](#)

Ben loves cutting stuff, any stuff. There's no longer a shelf to store these tools on (it's now two shelves), and the door's in danger.

Usually, when we build circuits, we use some form of metal as the conductor. This allows electricity to flow, as a quirk of chemistry means that electrons can move freely through metallic structures, and there's little resistance to this flow. However, metals aren't our only choice. One conductor popular with science teachers is conductive dough.

There are recipes for various conductive doughs online but most commercial play-doughs are conductive and can be picked up cheaply. We tested out three brands (Poundland, Nickelodeon Junior, and Play-Doh), and found all performed roughly equally (and within our margin for error).

These doughs don't allow electrons to flow, but instead, the liquid part of the dough contains ions,

or charged particles. These particles are usually bound together to form a single substance, but can separate to form an electrical current.

For example, many of these doughs contain salt, or sodium chloride (NaCl). When an electric current passes through salt water, this NaCl splits into Na and Cl ions that carry a positive and negative charge respectively. These ions move through the substance carrying the electric current in the same way that electrons do in a metal.

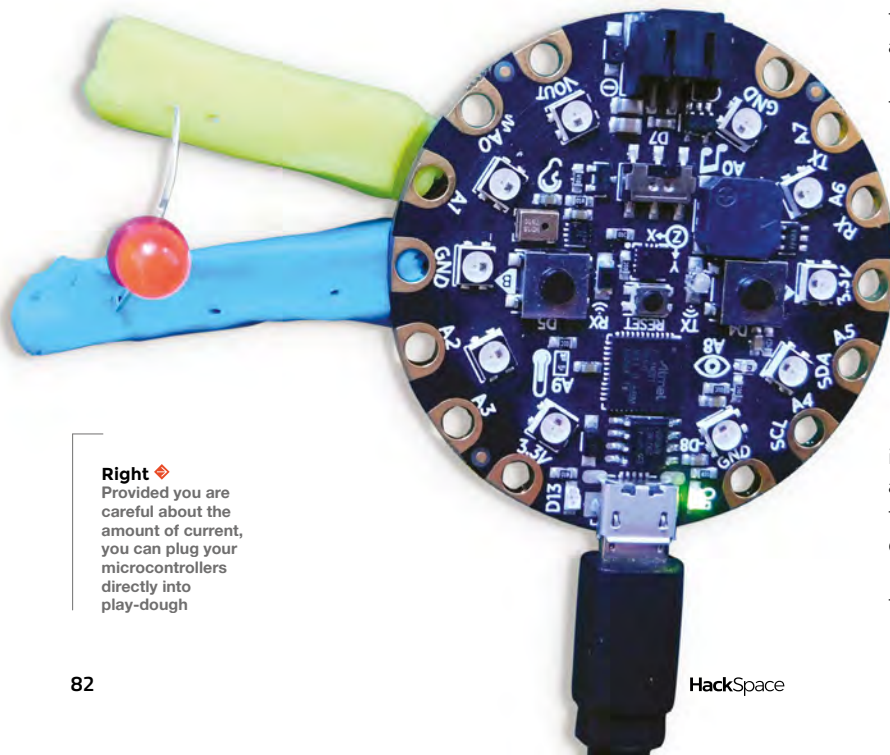
Let's take a look at what this means in practice.

## RESISTANCE IS FUTILE

The most important thing we need to know about our conductors is how conductive they actually are. So, we fashioned our doughs into puck-shaped pieces and used our multimeter to read the resistance of a roughly 1cm-thick chunk. It was about 2 MΩ (megohms). Obviously we're not going to be able to make a circuit out of this, but there are a few problems with the reading.

Firstly, what chunk of material are we measuring the resistance of? The shape of the blob of dough is critical to the resistance. Obviously, the length is important, as the longer the bit of dough we're trying to pass current through, the more resistance we will have. The width (or more accurately, cross-sectional area) is also really important, as the larger the cross-sectional area, the lower the resistance (you can think of this a bit like having resistors in parallel, or, if you'd prefer, like cars travelling down a multi-lane highway where the more lanes there are, the more cars can travel easily). This also introduces problems because the cross-sectional area is important, but if we're only applying a current to a point on either end, then the full width doesn't come into play.

The second part that introduces complexity is that the multimeter can't measure resistance. It



**Right** ♦ Provided you are careful about the amount of current, you can plug your microcontrollers directly into play-dough

can measure voltage and current – to find out the resistance, it applies a small voltage and measures the current, then uses Ohm’s law ( $I = V / R$ ) to calculate the resistance. This works well for good conductors, but can go astray.

All we want to do is play with some dough and things are getting a bit strange, so let’s take a step back and try to simplify it.

We made our dough into pucks about 1 cm deep and 5 cm across, then put a sheet of tin-foil over each end. This tin-foil serves two purposes: firstly it ensures that we get a good electrical connection to the dough across the whole width of the puck, and secondly it protects our electrodes. The ions that arrive from the dough can react with the metal on the electrodes and corrode them. Using foil as a sacrificial electrode protects our real ones.

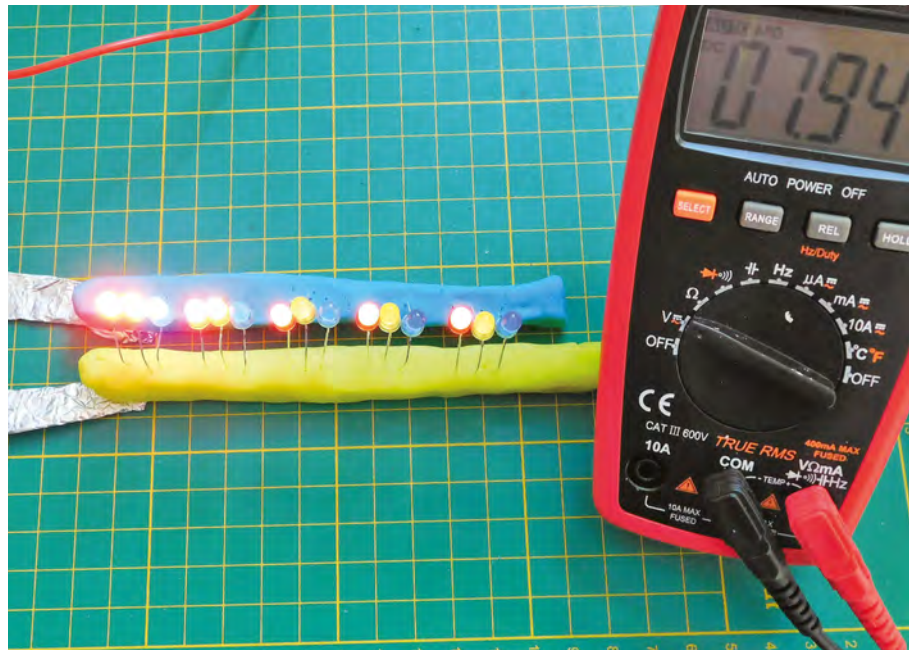
Now, let’s take a bit more control over measuring the resistance. Rather than use the multimeter to measure resistance, we used a bench power supply to provide various voltages, and then used two multimeters to measure the voltage and current, and from this we worked out the resistance of the material at different voltages.

At 0.5V, our puck had 625Ω, at 1V it had 261Ω, and then over 2V it stabilised at about 80Ω. Above about 8V, it started fizzing and the resistance started to drop again to about 20Ω at 10V. You can see the results in **Table 1**.

Because there are ions transporting the current rather than electrons, we end up with an accumulation of different ions at the electrodes. Without knowing the exact composition of the dough, it’s a little hard to know what these ions are, but it’s a good bet that salt forms quite a sizeable part of the electrolytes in the dough, which means that there’ll be an accumulation of chlorine on one electrode.

**Table 1** ♦  
The resistance of a puck of play-dough at different voltages

VOLTS	CURRENT (mA)	CURRENT (A)	OHMS
0.5	00.8	0.0008	625
1	03.83	0.00383	261
2	24.0	0.0240	83.4
3	33.9	0.0339	88.5
4	56.7	0.0567	70.5
5	63.4	0.0634	78.9
10	423	0.423	23.6



## SQUISHY CIRCUITS

We are far from the first people to discover that doughs can be conductive. In fact, there’s even a company selling parts specifically for this – Squishy Circuits ([squishycircuits.com](http://squishycircuits.com)). On the website, you’ll find its recipe for dough and a selection of example projects. It also has a store with bits of hardware specifically designed to work with dough.

Some of this is will be absorbed into the water, some of it will react with the various other chemicals there, but some will be given off as a gas (hence the fizzing). This gas isn’t a big concern, as long as you keep the current low (as the amount of gas given off is proportional to the current). As a general rule of thumb to stay safe, keep the voltage under 5V, don’t work in a confined space, and don’t stick your face too close to the electrode. Don’t just keep pumping high voltages through, unless you take proper precautions. →

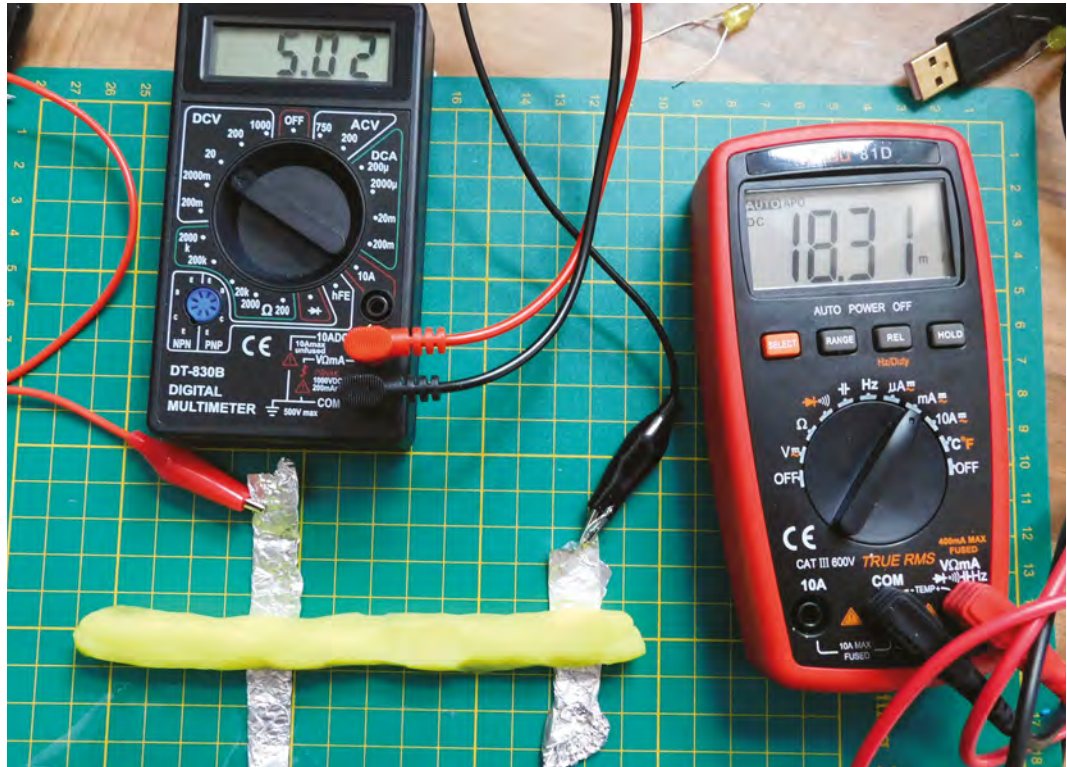
**Above** ♦  
We found that the forward voltage had a big impact on how the LEDs worked, even at voltages well above the forward voltage (red: 1.8V, yellow: 1.86, blue: 2.6)

## YOU’LL NEED

- ♦ Play-dough
- ♦ Power supply or batteries
- ♦ LEDs
- ♦ Multimeter
- ♦ Microcontroller (optional)



TUTORIAL



**Right** ♦  
The biggest challenge for testing the resistance was ensuring a good joint between electrode and dough

**THEORY TO PRACTICE**

Let's now take a look at how we can use this dough to build a circuit.

Most red LEDs need a voltage of around 1.8V to turn on. Below this, they simply won't give out any light. The resistance of the dough will mean that we need more than this. In a simple setup with the LED's legs both in a puck of dough, we found that we needed over 2.7V to get a noticeable light on the LED, and 3V gave a reasonable glow.

As we mentioned earlier, the electrodes are subject to quite a bit of corrosion, and the legs of the LEDs are, for these purposes, electrodes. They will corrode and break with use (expect them to last a few hours each).

3V is what we get off most microcontrollers, so you can run this straight from a microcontroller. The biggest challenge is getting the output from the microcontroller into the dough. We used a Circuit

Playground Express, since the large pads are easy to press into dough.

Another problem is that it's hard to know what the actual resistance of your circuit is – this is especially true as the connection between your microcontroller and dough might be a significant source of resistance. At 3V, you're unlikely to blow the LED, but more concerningly, you might draw too much current from your microcontroller. Depending on how risk-averse you are, you could try a few options here: using a motor controller, rather than pulling the current directly from the GPIO pin should be safer, as these can handle significantly more current (though check what voltage your motor controller puts out). Alternatively, you could just chance it and, provided you use a long enough length of dough, you should have enough resistance to be safe. How much is long enough, though?

**Table 2** ♦  
The resistance of different lengths of a 1cm square cross-section of play-dough

DISTANCE (cm)	VOLTS	CURRENT (mA)	CURRENT (A)	OHMS	OHMS PER CM
1	5	72	0.072	69.4	69.4
2	5	40	0.04	125	62.5
3	5	32	0.032	156	52.1
4	5	26	0.026	192	48.1
5	5	23	0.023	217	43.5
6	5	20	0.020	250	41.7
7	5	18.5	0.0185	270	38.6

Since we got an unusual resistance compared to the voltage, rather than rely on extrapolating the resistance of the dough over length, we tested out the resistance of the dough. We used an approximately 1×1 cm square cross-section (which got a little deformed as we worked) and measured the resistance at different lengths. You can view the results in **Table 2**. As you can see, this is non-linear: at short lengths we had around 70Ω per centimetre, while at longer lengths we had around 40Ω per centimetre. This could be because a significant amount of the resistance is at the joint between the electrode and the dough.

On the Circuit Playground Express, the GPIO pins output 3.3V and are rated to 10 mA (with 7 mA recommended). So, given the 1.8V forward voltage on the red LED, we need at least 150Ω of resistance. There will be two lengths of dough (one from the GPIO to the LED, and one from the LED to the ground), so each one needs at least 75Ω resistance. From our table, we can see that 2 cm should be enough, but prudence suggests a few more, at least

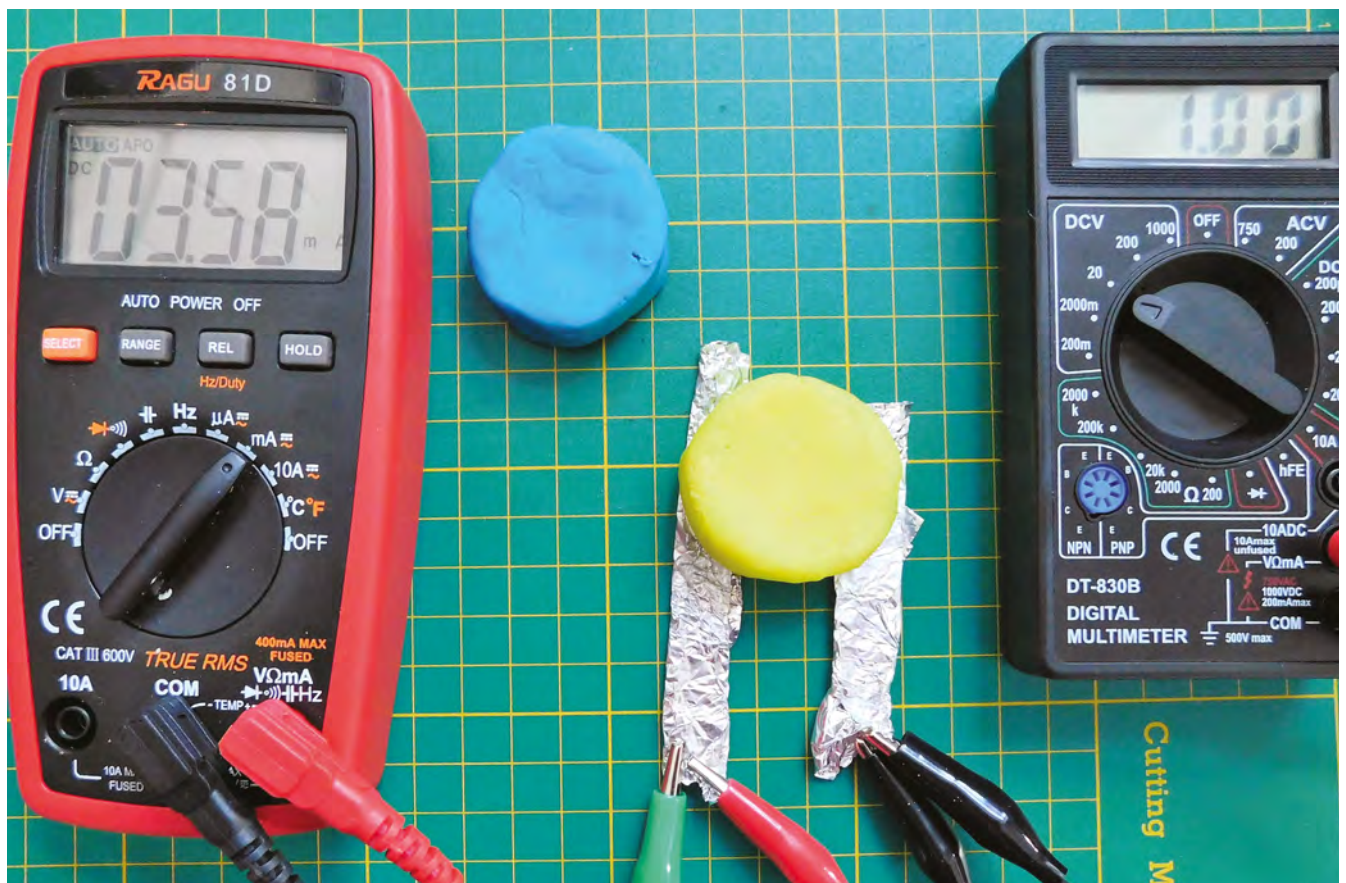
## INSULATOR

Perhaps a little surprisingly, it's harder to get an electrical insulator dough than a conductor. Blu Tack is one option, but it can be expensive in large quantities. Fortunately, the good folk at Squishy Circuits (see other boxout) have come up with a recipe involving flour and sugar that has a fairly high resistance, and can be combined with conductive dough to build three-dimensional circuits.

for the initial circuit (it's easy to remove dough, but it's impossible to put the magic smoke back in if you blow your microcontroller).

Remember, all this is based around one microcontroller, and the particular properties of the dough we had. Our experiences with this dough suggest that using 4 or 5 cm of dough for each connection should be plenty to protect most microcontrollers or single-board computers, but don't blame us if yours go pop – this isn't a precise science. □

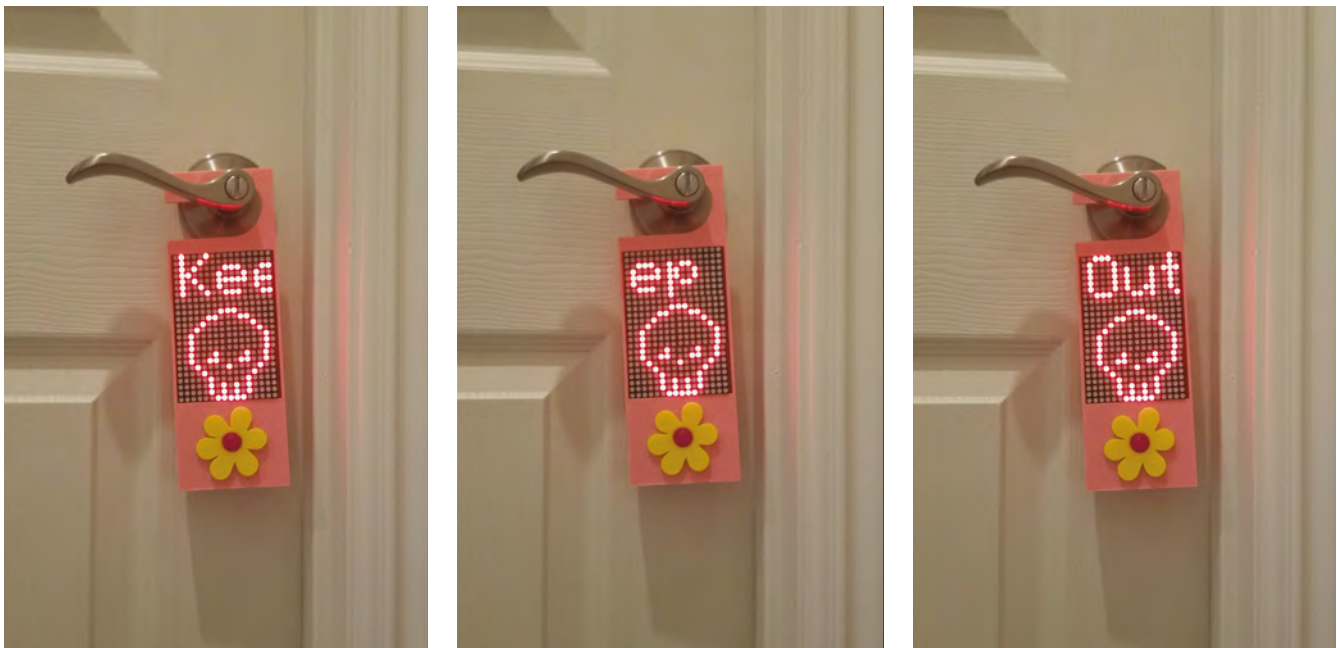
**Below** □  
Low voltages proved a particular problem for our play-dough





# LED door hanger

Protect your room with a configurable sign



Mari DeGrazia

[@maridegrazia](#)

Mari DeGrazia is a Director at Kroll Cyber Security. In her spare time, she volunteers at a smARTMAKER lab in Arizona.

**M**y daughter plays online Dungeons and Dragons (D&D) games once a week. To keep me from barging into her room and embarrassing her while she chats with her online friends, she hung a paper sign on her door that read 'Knock or text before entering'. I saw the sign on the door and thought, 'Surely we can do better than this'.

I wanted something that would hang on her door without damaging it – no tape or nails. Since I travel a lot for work, I immediately thought of a door hanger used in hotels for privacy. I created a 3D-printed case which holds a grid of six LED matrices, an ESP8266 microcontroller, and a battery. A message scrolls across the top two matrices, and a picture is displayed on the bottom four. Alternately, an animation can be played across the entire grid, such as Pac-Man. The message and picture are controlled through a web-based page served up by the ESP8266. Now my daughter can change the message

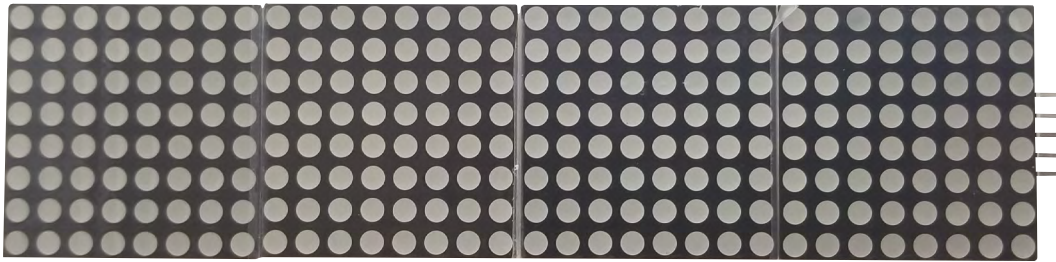
and picture to suit her mood, and I don't have to look at a plain sign taped to a door when I walk by.

## LED MATRIX

The first step is assembling the LED matrices. The MAX7219 Dot Matrix Modules are a good choice for a couple of reasons. First, the matrices can be daisy-chained to create whatever size display is needed. Because the 2x3 grid size was somewhat unconventional, this gave me the most flexibility. Second, there are numerous tutorials and libraries available online for the MAX7219, which makes the learning curve less steep.

The case fits the Cylewet MAX7219 Matrix Module, which comes with four matrices. Since we will need six LED matrices, two of these modules will be needed. The modules comprise the LED matrix itself, and a backplate that makes it easier to control.

It's easier to work with the matrices when the LEDs are removed. Before you remove them, take note of how they are oriented. Ours had a stamp



**Left** ♦ Four LED matrices arranged next to each other

that said '1088AS', which was on the top side of the screen. Gently pull the LED screens until they come off. The pins might bend a little bit when they are removed, which is OK.

After the LED screens have been removed, we will need to break the module in half. To do this, score the board in the middle, and snap it in half.

For the matrices to fit into the case, the pins at the ends of the modules will need to be removed. Desolder the pins by clipping the black plastic parts off. Once these black parts are removed, desolder the pins by touching the rear side with a soldering iron, and pull the pins out from the other side.

Take a look at the backside of one of the matrices. Note how there is a DIN pin and arrows with an IN and OUT designation. These arrows indicate the direction of the data flow.

We will wire all the matrices together in the 2x3 grid shape. We'll wire it so that each module's DOUT is connected the next module's DIN. Each of the

“ **After the LED screens have been removed, we will need to break the module in half** ”

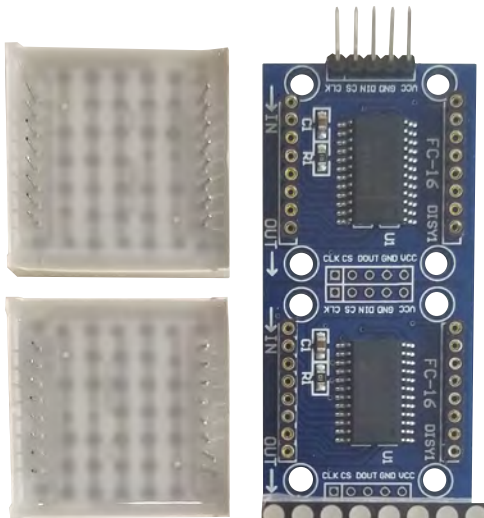
respective pins (VCC, GND, CS, CLK) will connect directly to the next module's same pins. I used wires that were approximately 9.5 cm long. Make sure that the wires poke out of the rear side and are soldered onto the front, otherwise they will not fit into the case quite right. Also, note the notation of the text. The In and Out arrows are oriented towards the top, and the text is upside down.

Next, we will put the LED screens back onto the matrices. This will require a little bit of patience and finesse. We found that using a pair of tweezers to move the pins, as we pushed them into place, >

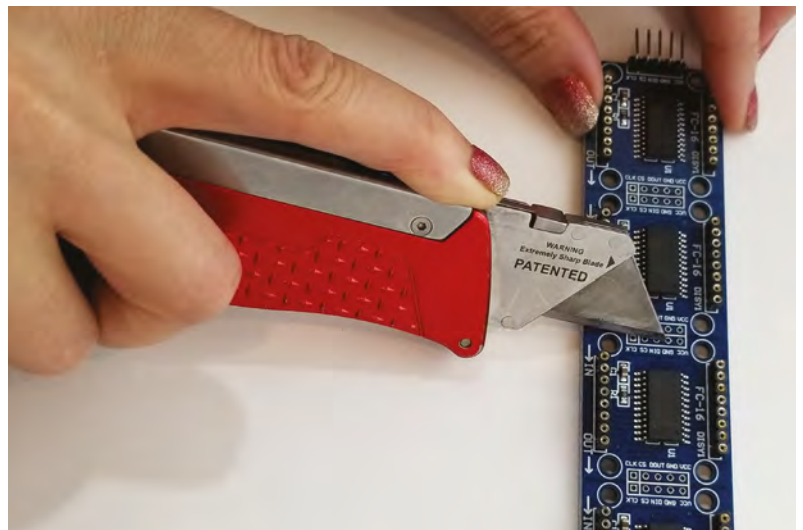
**YOU'LL NEED**

- ♦ **Adafruit Feather Huzzah (loose headers)**  
hsmag.cc/zpfSwT
- ♦ **Cylewet MAX7219 Dot Matrix Module 4-in-1 Display**  
hsmag.cc/yJUvWT
- ♦ **LiPo battery, 2500 mAh**  
hsmag.cc/FWaSFU
- ♦ **Slide switch**  
hsmag.cc/glqHMR
- ♦ **Wires**
- ♦ **Double-sided foam tape**
- ♦ **Hot glue**

**Below** □ Scoring the MAX7219 module in the middle to make it easier to break

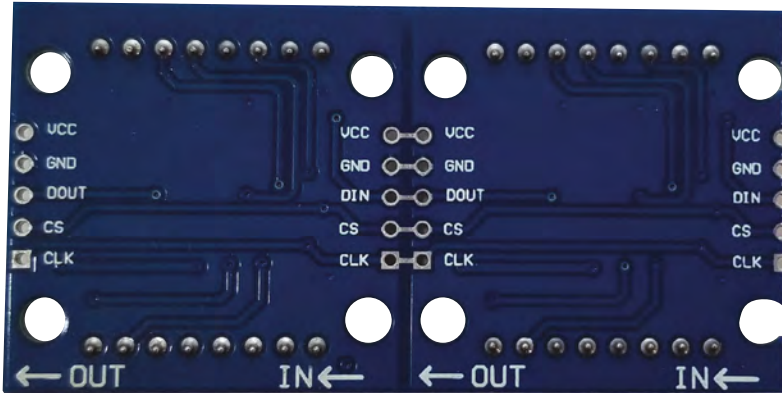


**Right** □ LED screens removed from the MAX7219 module





## TUTORIAL



**Above** Direction of the data flow

helped. Remember to orient the LED screens correctly when you put them back in or they will not work.

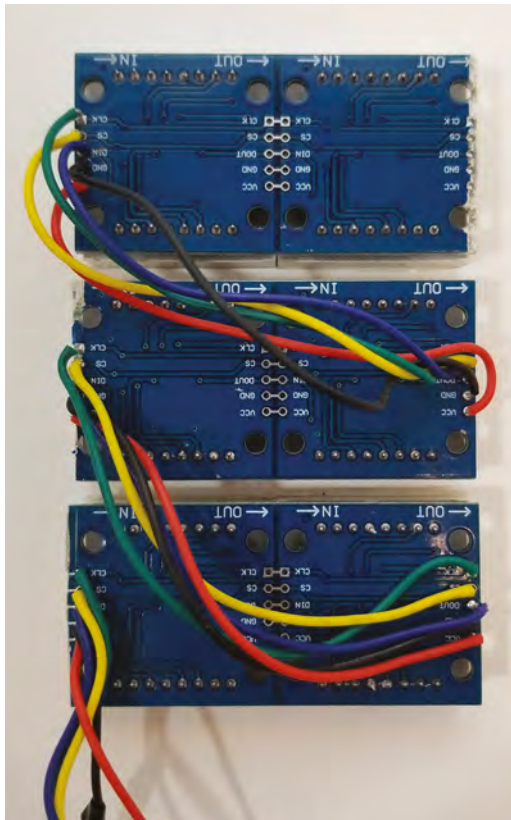
### MICROCONTROLLER

We wanted the user to be able to control and personalise the scrolling message and picture that would be displayed on the LED door hanger, and a web-based interface is a simple way of allowing this. The webpage could be accessed from a computer or smartphone.

Another design requirement is that the LED door hanger runs off a rechargeable battery that lasts for at least four hours (the length of one D&D session).

**Right** Wiring the matrices together, so the data flows through the six units

**Below** Removing the pins from the MAX7219 board



The Feather Huzzah has an ESP8266 WiFi board which can be configured to set up its own wireless access point. This means the LED door hanger does not need to connect to a wireless network, and can work as a standalone device. The Feather Huzzah also comes with a built-in JST connector, which is perfect for attaching a LiPo battery. We put a hole in the bottom of the case where a USB cable can be attached to the Feather Huzzah to upload code and recharge the battery. There is also an LED light on the Feather Huzzah that comes on when it's charging.

The LED matrix will attach to the Feather Huzzah using the SCK, MOSI, MISO, Ground, and 3V pins.

**// We wanted the user to be able to control and personalise the scrolling message and picture //**

To power the LED door hanger on and off, a slide switch will be used. The switch will be connected to the Ground and EN pins on the Feather Huzzah.

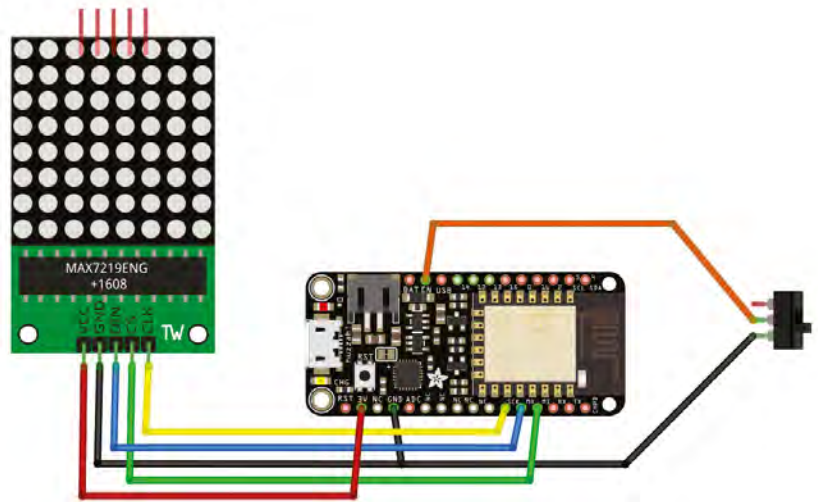
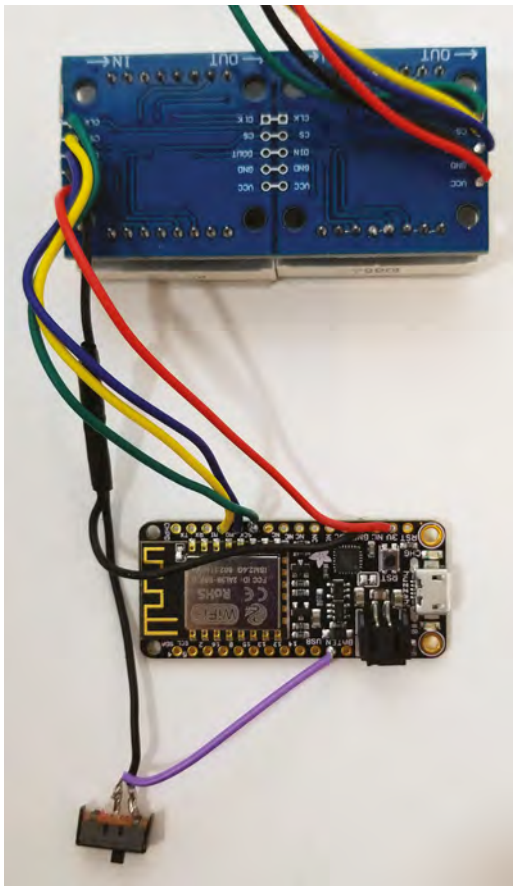
### The connections are:

- Matrix CLK to Huzzah SCK/14
- Matrix CS to Huzzah MISO/12
- Matrix Data In to Huzzah MOSI/13
- Matrix VSS to the Huzzah 3V
- Switch to Huzzah GND
- Switch to Huzzah EN

### 3D CASE

The case is based on a Thingiverse design by KyroPaul, but modified to include the matrices, and has an area for the microcontroller and battery. There's also a cover that slides into grooves on the back to encase everything when it's all put together. The files can be downloaded from Thingiverse at: [hsmag.cc/RoQrIG](https://www.thingiverse.com/thing:458888).

The 3D-printed case is where you can have some fun personalising the project. The front has a nice square section where you can add a little flair. This maker searched on Tinkercad for flowers, found several variations that worked nicely, and printed out a flower in two colours on a dual extrusion printer. However, you don't need to have a dual extrusion printer to have multiple colours. For example, you could print the flower petals in one colour, and the flower bud in another, then glue them together.



**Above**  Wiring the LED matrices is simply a case of connecting a few pins to the appropriate connections on the matrices

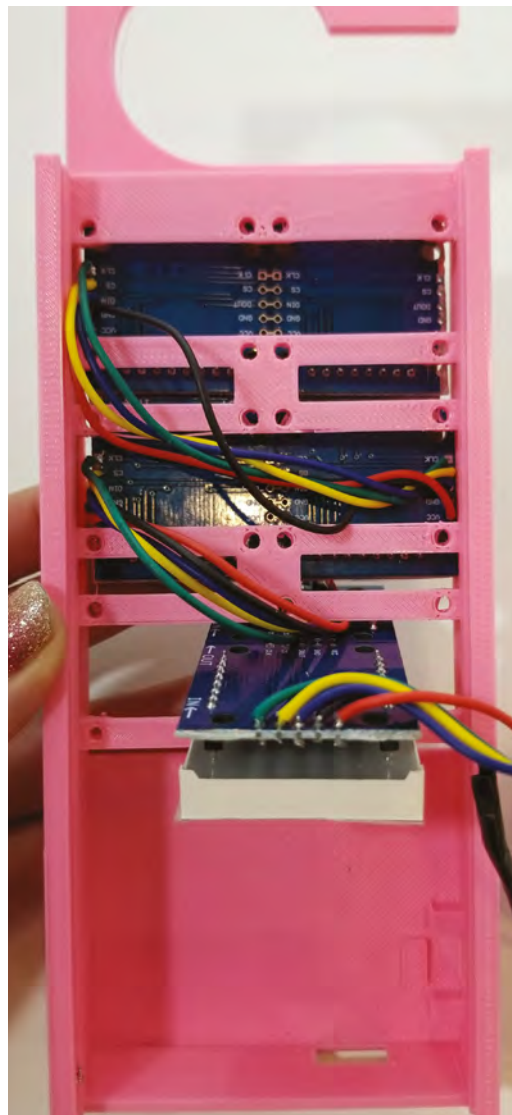
**Left**  Putting the matrices into the case

**Above**  The Feather Huzzah, wired to the MAX7219 grid

Once the case is printed, the matrices, Feather Huzzah, and slide switch can be put into the case. Starting with the top-most matrix, thread the matrices through the larger slots on the back of the case, to the front of the case. Once threaded through, orient the matrices with the In and Out arrows at the top. The writing on the back of the matrices will be upside down.

Once the matrices have been threaded through and oriented correctly, wiggle them all down into the case from the front side. It's a tight fit, but they do fit! The tight fit is what keeps them in place. If desired, use some M3 screws on the back grid to secure it, or some hot glue.

Place the switch in the switch holder, and line up the Huzzah's USB port with the hole in the bottom of the case. A piece of double-sided foam tape holds the board down nicely, and some hot glue on the switch will hold it securely. However, before you tack them both down, you may want to upload the code first, to make sure everything is working as it should be. Finally, a LiPo battery can be plugged into the JST connector and seated in the case. →





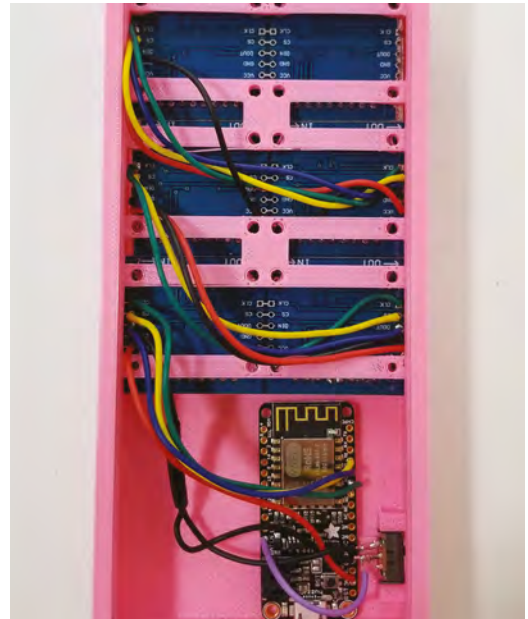


**Far Right** ◆

The Feather Huzzah and slide switch in the case

**Right** ◆

The hole is the perfect size for the matrices, so they push firmly into place

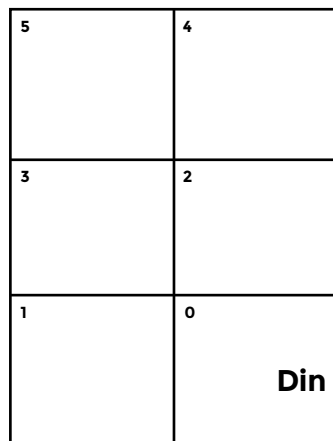


### CODE

There are two modes of operation for this door hanger. In one, the top two matrices show the text, while the bottom four have an image. In the second, all six matrices are used to display an animation.

The matrices are ordered 0 to 5, starting from where they are plugged into the Huzzah board and facing the front.

The MD Parola library, by Marco Colli, allows you to split up the matrix display into zones. Using the zones feature, we can designate the top two matrices for scrolling text (4 and 5), which keeps the bottom four (0,1,2,3) free to hold a picture. We can then create another zone that encompasses all the matrices (0–5) for when we want to use the animated sprite feature of the MD Parola library. The animated sprites have cool animations like Pac-Man and Space Invaders that move across the screen.



**Figure 2** ◆

The logical layout of the matrices

To display an image on matrices 0,1,2, and 3 we can use a library called LED Control. LED Control allows you to turn specific pixels on or off. Because the matrices wrap around, displaying an image on them turned out to be tricky. The function `displayImage()` handles this so you don't have to worry about it! You can get the code from: [hsmag.cc/XkACPs](http://hsmag.cc/XkACPs).

### UP AND RUNNING

To upload the code to the Feather Huzzah, you will need the Arduino IDE loaded. Follow the instructions on Adafruit to get your Feather Huzzah up and running: [hsmag.cc/mHCzOS](http://hsmag.cc/mHCzOS).

You will need to install some additional libraries to support the LED door hanger code. In the Arduino IDE, go to Sketch > Include Library > Manage Library. Install the following libraries by typing their names in the 'Filter your Search' field: LEDControl, MD\_Parola, MD\_MAX72XX.

At the top of the code, note the SSID and password you will need to connect to the LED door hanger. Once the door hanger is powered on, connect to the SSID and with any web browser (including your phone), and enter this address: <http://192.168.4.1>.

You will be presented with a webpage that will allow you to choose the message and picture to be displayed.

### MAKE YOUR OWN PICTURES

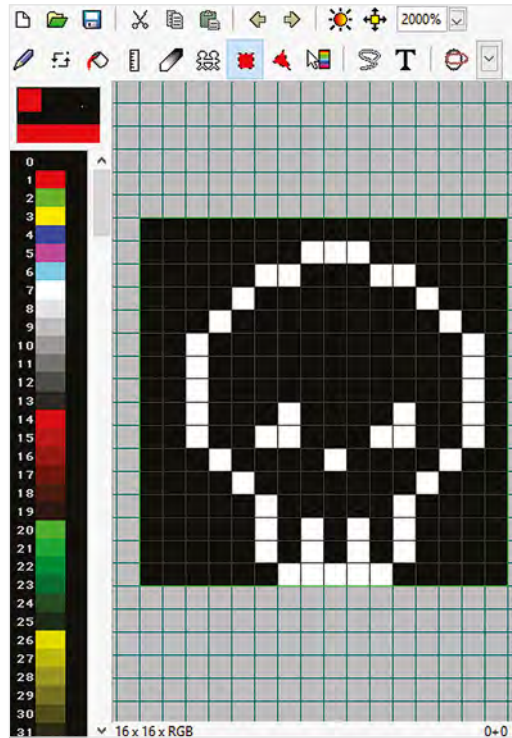
We've created some images that are useful for us: skull, sad emoji, happy emoji, chill emoji, heart-eyes emoji, and a Do Not Enter sign. You can design your own bitmaps to display on the grid using a program called mtPaint to create an image that's 16x16 pixels.

This is the same number of pixels that covers the four matrices. Make the background black, and draw the picture you want in white. The white translates to the pixels that will be turned on.

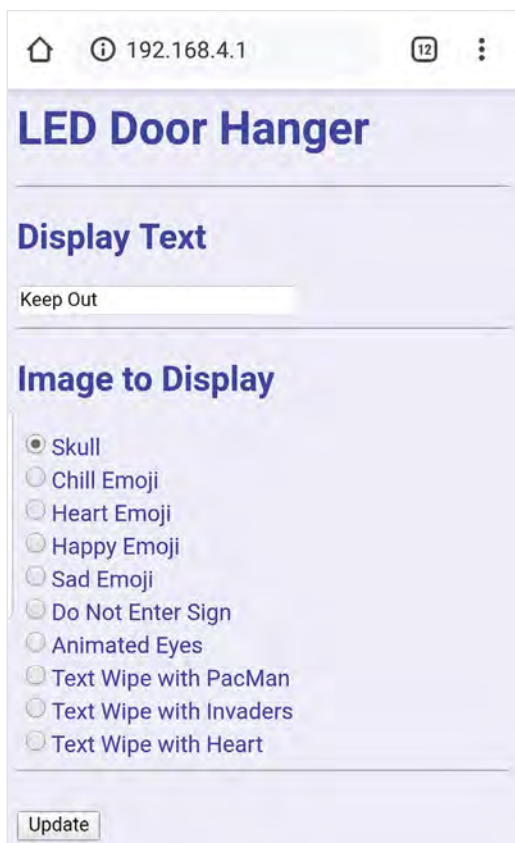
Once completed, save the file as a PNG file, and upload it to the following site: [hsmag.cc/SFFLvb](http://hsmag.cc/SFFLvb). This site will generate the plain byte code from the picture. This byte code is what is needed by the program to display an image. Once you have the byte code, find the section in the code that says, 'Images to display on the 16x16 grid'. Simply create a new variable using an existing one as an example, and copy and paste your bitmap code in:

```
byte myImage[32]=
{0x00, 0x00, 0x01, 0xc0, 0x06, 0x30, 0x08,
0x08, 0x10, 0x04, 0x20, 0x02, 0x20, 0x02, 0x20,
0x02,0x22, 0x12, 0x26, 0x32, 0x10, 0x84, 0x08,
0x08, 0x04, 0x10, 0x05, 0x50, 0x05, 0x50, 0x03,
0xe0};
```

Now that you have the picture, you will need to add a radio button for it on the webpage. Find the



**Left** You can create any image you like provided it fits on 16x16 LEDs



`void HandleClient()` function and look for the line that says:

```
webpage += "<input type='radio' name='image'
value='skull'>Skull<br>";
```

Copy this line and insert it just below. Change the word `skull` to the name of the picture variable you created above:

```
webpage += "<input type='radio' name='image'
value='myImage'>My Image<br>";
```

Lastly, look for the line of the code that says `//uncomment below lines if you add in a new image`. Uncomment the `if` statement and change `myImage` to the name of the picture variable you created:

```
if (newImage == "myImage") {
    displayImage(myImage);
}
```

Your new image should now show up as an option on the webpage, and display when you select it!

**Figure 3** The webpage for configuring the door hanger



# Build your own storage tray

A useful storage project, made using a hand-held router



Andy Clark

@workshopshed

For the last ten years, Andy has been making and repairing in a shed at the bottom of the garden. You can see more of his exploits at [workshopshed.com](http://workshopshed.com)



**Left** Level up your skills and tidy your workshop

are not too critical as long as the pairs of sides are the same length (and the base is big enough to fit in between them).

## YOU'LL NEED

- ◆ **Softwood**  
44 × 12 × 1500 mm
- ◆ **Plywood**  
6 mm × 435 × 285
- ◆ **Electric hand-held plunge router**
- ◆ **Portable workbench**
- ◆ **6 mm plunge bit**
- ◆ **16 mm straight bit**
- ◆ **Round-over router bit**
- ◆ **A couple of large battens, or short planks**

**W**hen working with small components, one of the best ways to store them for easy access is a shallow tray. This project shows you how to build one using a hand-held woodworking router.

A router is a tool for putting grooves in wood. It basically consists of a spinning shaft, a bit like a drill bit, that can cut sideways. Using this, we can carve out the joints and handles that we need for our tray. If you want to take this further, you could also carve out a design on the side,

The corners of the tray use box or finger joints, which provide a strong joint that does not twist. The base of the tray is held in a routed slot. The handles are cut, then rounded with the router.

Cut the four sides slightly overlength, and then sand the end grain to give a smooth end. The lengths

## GROOVY SLOTS

The first step is to cut the slots for the bottom of the tray. This requires a cutter that can plunge into the work. If you look at the end of a plunge cutter, you will see that the cutting blades pass over the centre line. This means it will cut all the way to the middle.

Mark the ends of the slots in pencil on the boards; these should be 20mm in from the ends.

Clamp the wood in the workbench, ensuring that the top face of the wood is flush with the bench. Attach the fence to the router, and adjust so that the edge of the cutter is 4mm from the edge of the wood. Adjust the depth stop for the router to 6mm.

## SAFETY

The key safety points for a router are similar to other power tools. Before working, check the machine is in good working order. Ensure the machine is turned off/unplugged and stopped before changing the cutters. Use the right-sized collet for your cutter, and ensure it is inserted fully, and tightly clamped before use. Avoid loose clothing and check hair is safely out of the way.

Ensure there is space to work, and that others in the same area know you are routing. Goggles, or a full face guard, will protect your eyes from debris.

If your router is noisy, then use ear defenders or ear plugs to protect your hearing, and always follow the manufacturer's instructions.



## QUICK TIP

If you don't have a plunge router, drill pilot holes at the ends of the slots.

**Left**  6mm plunge cutter

**Below**  Slot for the base

With the fence towards you, move the router from left to right. The rotation of the cutter should pull the fence against the wood, helping you to get a straighter slot. Repeat for the other four sides.

## WOOD FINGERS

To cut the fingers, we used a couple of planks to support the router. Use a square to ensure these are perpendicular to the work and bench. Take the tray's longer sides and clamp them vertically in the bench. Orient the wood so that the slot is towards the right-hand side plank. Ensure the work is flush up against the plank.



The rotation of the cutter should **pull the fence against the wood**, helping you to get a straighter slot



Adjust the router's depth stop to just more than 12mm, and adjust the fence so that the cutter is just rubbing against the plank. Turn on the router and make a full-depth path across the wood, cutting a slot. Turn off the router.

Taking care not to move the router, loosen the screws on the fence, and slide it out 12mm (2 × cutter diameter). The best way to do this is to find a piece of wood or metal that you can use as a spacer. Tighten the fence and remove the spacer. Now, pull the fence tight against the plank to make the second cut. Repeat these steps until all four slots are cut. Note that this approach will accumulate any errors, so may not work with larger boxes. →





**Above** ♦  
Cut the fingers with the wood vertical in the vice

**Below** ▣  
Setup for finger joints

Turn the long side the other way up and, again, ensure the slot is towards the right-hand side plank. Repeat the above steps to produce four slots on the other end of the side.

For the shorter sides, we need to offset the slots by a cutter's width. As before, set up the router with the cutter brushing the right-hand plank. Loosen the fence screws, and this time slip in a spacer for 6mm (one cutter width). Tighten the fence screws, and remove the spacer. Now, cut the first slot. Repeat, as before, for the other slots using the larger spacer.

The planks can be removed, as they are not needed for the next steps.

### ROUTED HANDLES

The handle slots require several steps to complete: a clearance slot, cutting to size, and rounding. We will also be cutting all the way through the boards. For each of the shorter sides, mark the ends of the handle slots with a pencil; these should be 11 mm in



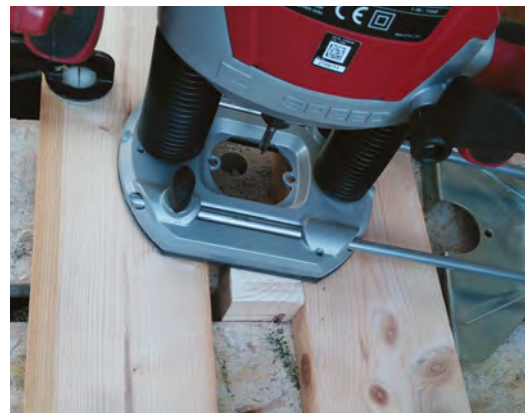
**Above** ♦  
Straight cutters give holes with straight sides

from the ends. Clamp the board in the bench, again ensuring that the top face of the wood is flush with the bench.

Looking at the end of the straight cutter, you'll see the blades do not go to the middle. It will only cut on the sides. So, before cutting the slot for the handles, we need to cut a clearance slot. Adjust the fence to 15mm, and the depth stop to >12mm, e.g. 14mm. Cut a slot for the handle. Repeat for the other piece.

For the next cut, we need the same depth and fence settings. Swap to the 16mm cutter, and note that you may need to swap collets for this. Cut the wider slot. Repeat for the other end.

Swap the 16mm cutter for a round-over cutter. This cutter has a bearing on it. Adjust the depth, so that



### QUICK TIP

Do some practice runs for these fingers on scrap wood.



**Far Left** ♦ Clearance cut

**Left** ♦ Cutting the handle slot

**//** Before assembling the tray, check that the fingers mesh correctly, and sand with a coarse paper



the curved portion of the cutter is level with the top of the work. Move the cutter away from the sides of the slot and start the machine. Press the bearing against the side of the slot, and make an anti-clockwise pass around the hole. Stop the machine and review. If necessary, adjust the height and repeat. Flip the board over and round the other side. Repeat this for both sides of the other end.

### IT'S ALL ABOUT THE BASE

The last part of the tray is the plywood base. This is a rectangle with the corners notched out. Mark the position of the notches, 10mm in from each end.



These cuts can be done freehand, or use a fence if you are not confident. You can use a second piece of 6mm ply to support the router.

Before assembling the tray, check that the fingers mesh correctly, and sand with a coarse paper. The aim is that they are a tight fit, but the wood is not crushed as you fit them together. To assemble, first add PVA glue to the fingers. Slot the base into one of the longer sides, then add one end. Continue with the other long side and the second short side.

Once the glue is dry, you can sand down any fingers that protrude, and your tray is complete. The final task is to finish the wood and protect your tray with a suitable varnish, oil, or paint. That's up to you, but don't forget to ensure that whatever you use is hard-wearing enough to withstand the bits and bobs in the tray. □

**Left** □ Round-over cutters give a softer edge

**Below** ♦ You might need some additional support while notching the corners

### OTHER IDEAS

You can use the techniques in this project to put together trays in a wide range of different configurations. Here are a few ways we think you could personalise it:

- Use 3mm ply to form dividers for your tray
- Use wider boards to form a box or drawer
- Use the trammel point, which comes with the router, to make curved handles





# Handy Sampler – sound glove with HalloWing

Create your own wearable audio sampler glove!



Sophy Wong

@sophywong

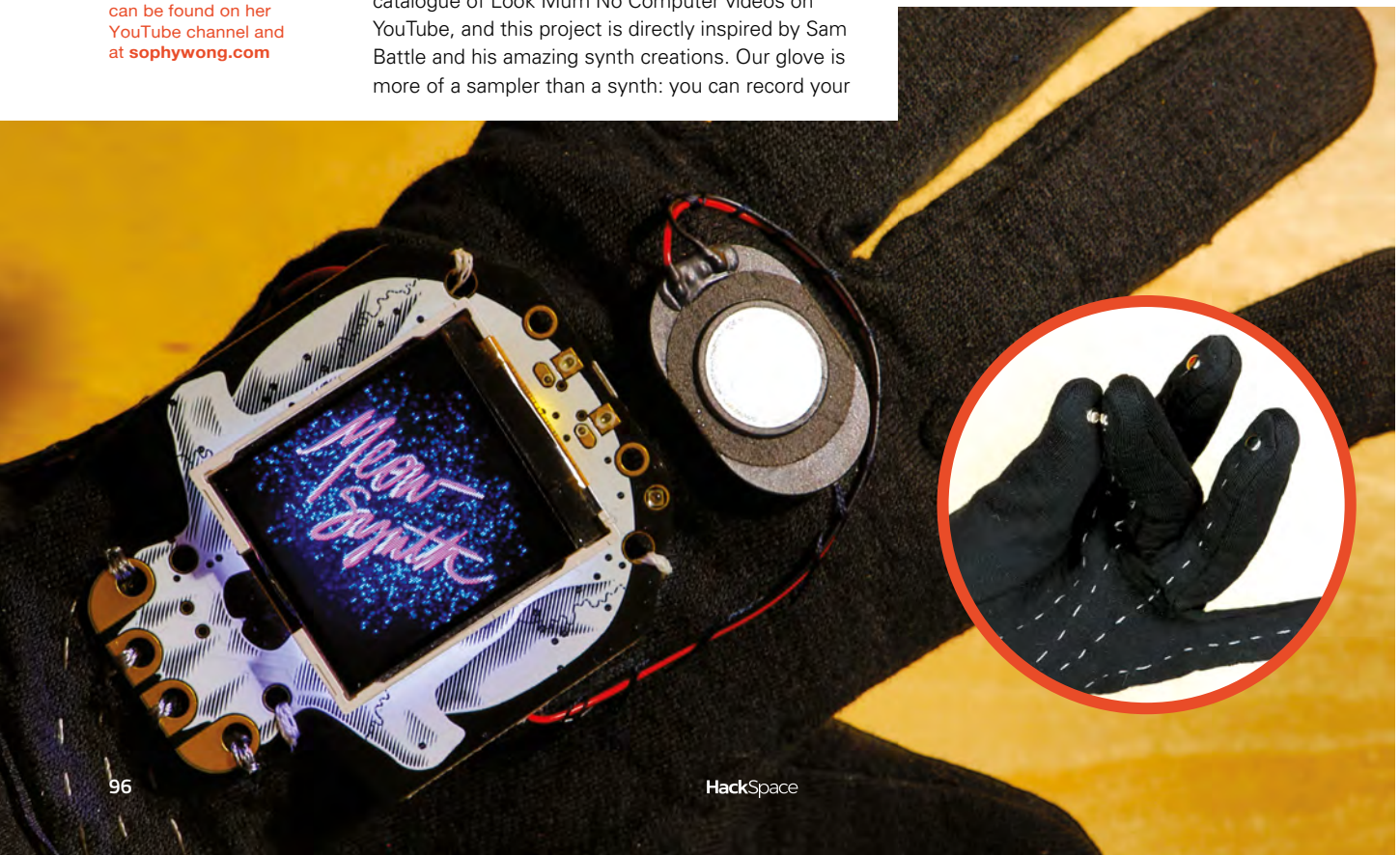
Sophy Wong is a designer, maker, and avid creator. Her projects range from period costumes to Arduino-driven wearable tech. She can be found on her YouTube channel and at [sophywong.com](http://sophywong.com)

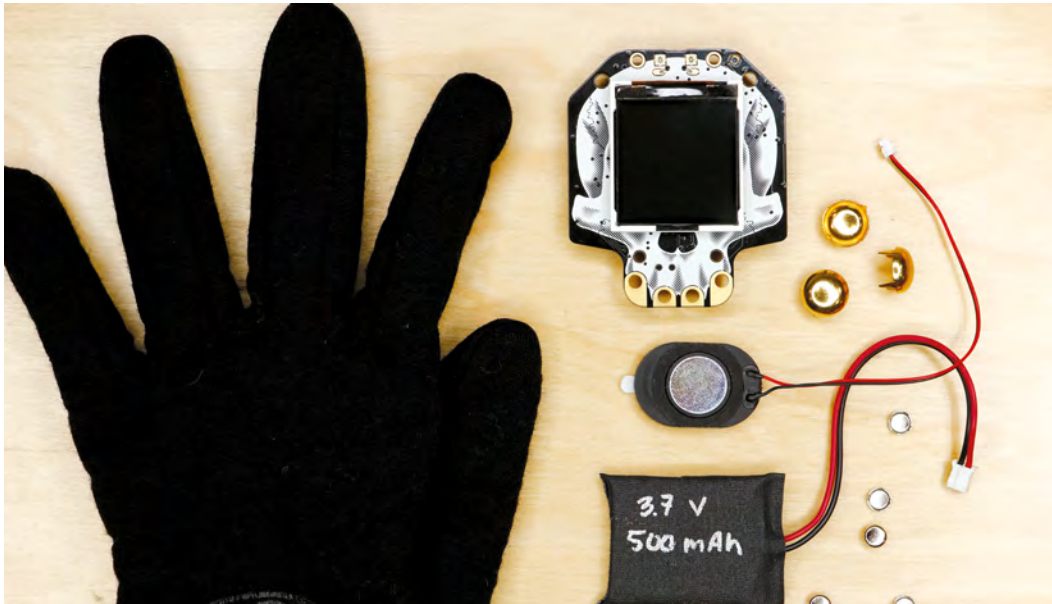
**H**ere at HackSpace magazine, we couldn't wait to get our hands on the new HalloWing M0 Express from Adafruit! Based on the Feather M0 Express microcontroller, the HalloWing comes packed with on-board features like a 1.44" full-colour TFT display, accelerometer, light sensor, speaker driver, and JST ports for connecting NeoPixel strips, sensor inputs, and more. All of this, plus a built-in on-off switch, means the HalloWing is just asking to be put into a wearable project – that's what we did. Behold, the Handy Sampler: a wearable audio sampler glove!

Your author has been burning through the back catalogue of Look Mum No Computer videos on YouTube, and this project is directly inspired by Sam Battle and his amazing synth creations. Our glove is more of a sampler than a synth: you can record your

own sounds and load them into the 8MB of SPI flash on the HalloWing. We added capacitive touch sensors to the tips of the fingers for triggering each sound. Just press your thumb and finger together to trigger one of four pre-recorded sounds. And the TFT display shows your awesome synth-pop band logo, or a picture of your cat, or anything else you can fit into a 128x128 pixel BMP image.

To record your samples, you can use audio software like Audacity, which is free. Your author recorded her own voice saying things like 'boing', 'boop', and 'meow' and saved each sound as a separate file to create a custom sample pack. Make sure to save your samples as 16-bit mono WAV files.



**Left** ◆

When assembling your components for a wearables project, it helps to pick ones that look good

**Below** ◆

Mark out your traces to avoid confusion when sewing



To create a graphic for the screen, your author sketched a quick band logo in Photoshop and saved it as an RGB BMP graphic. The screen is bright, but small, so flat colours and simple shapes will look best here. The final image should be saved as a 128×128 pixel 24-bit colour BMP file.

You will definitely want to create your own samples and image (have fun with this!), but to get started quickly, you can download our sample pack and the Meow Synth band logo image from here: ([hsmag.cc/issue13](http://hsmag.cc/issue13)).

Due to the HalloWing's handy ports, you won't need to solder anything to build this glove. The speaker plugs right in, and we'll use conductive thread to sew traces to each finger for capacitive touch inputs. Small metal rivets make great capacitive sensors and add a little bling to the cyberpunk aesthetic. Use your multimeter to check your rivets and make sure they're conductive. You won't need a sewing machine either, as this project is hand-sewn. Sewing components to the glove may seem more tedious than glue, but stitches hold more securely and are easy to remove – which means you can repurpose your HalloWing for another project later on.

The HalloWing requires a 3.7V LiPo battery for untethered power. LiPo batteries are tiny powerhouses that are great for wearables, but require proper handling and care for safe use. Do not puncture, compress, heat, or otherwise abuse these batteries. Ensure that you are using the correct charger for your battery, specified by the

manufacturer, as the chemistry of these batteries can vary by supplier. Adafruit stocks a special 400mAh LiPo battery that is specifically designed to fit between the headers on a Feather (or HalloWing), and, if you choose to use that battery, it's a simple matter of nestling it into the underside of your HalloWing. If you only have a larger LiPo battery on hand, we'll show you how to sew a custom pocket onto your glove that will fit your battery perfectly.

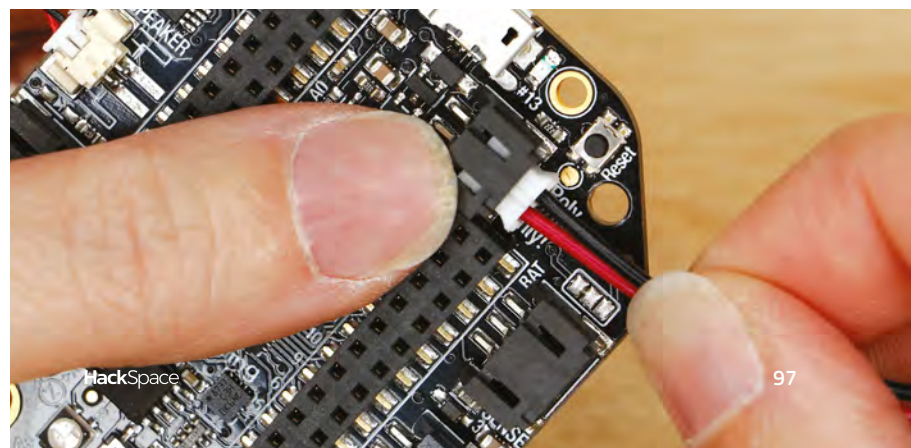
**DESIGN YOUR GLOVE**

Choose a thin glove that is a snug, but comfortable fit on your hand. A natural fibre with just a little bit of stretch works nicely. You'll be sewing the traces of your circuit on the glove while wearing it, so it's easiest to build this glove for your non-dominant hand.

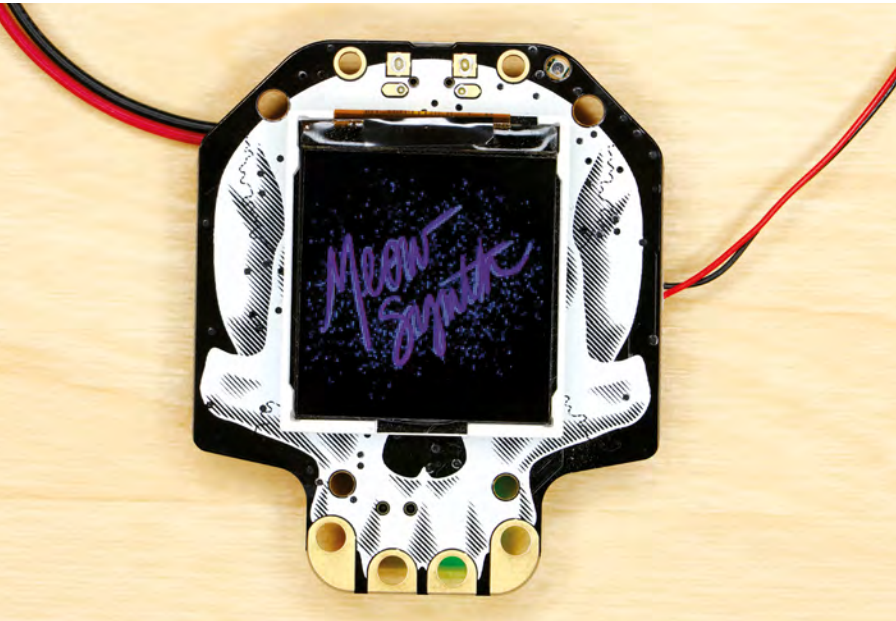
Plug the speaker into the speaker port, and the battery into its JST port. With the components connected, work out where everything will go on your glove, and draw out the paths for your circuit. →

**Below** ◆

Solderless connectors make it easy to reuse components for other projects







**Above** ♦  
A little creative work on the screen helps personalise this glove

Keep in mind that the on/off switch is on the back of the HalloWing, so you'll want to keep that accessible somehow. We cut a tiny hole in our glove so that the HalloWing can be switched on or off from the inside.

Draw lines from each of the four capacitive touch 'teeth' of the HalloWing to the tips of the four fingers on the underside of the glove (not the thumb). The sewn traces must not touch each other or pass under the wires of the battery or speaker. Although they are insulated, the wires can cause false triggering of the capacitive touchpads. It's best to keep everything

**// The first thing you'll want to do when you get your HalloWing is turn it on and see what it can do //**

separated on your glove as much as possible. On our glove, we routed all of the sewn traces around one side of the glove, which allowed the battery wire to run down the opposite side.

### PROGRAM THE HALLOWING

The first thing you'll want to do when you get your HalloWing is turn it on and see what it can do! Then, plug the HalloWing into your computer with a micro USB cable. The HalloWing comes with a cool spooky eye animation (running on Arduino code by Phil Burgess), so ogle that for a few minutes before reformatting it with Circuit Python. Double-click the reset button on HalloWing to enter bootloader mode; it will appear as a drive called HALLOWBOOT.

As always, the first step is to make sure that Circuit Python and the libraries on the board are up to date. This project requires a special version of Circuit

Python written for HalloWing that allows for use of the TFT screen, so download the latest 4.x HalloWing specific version of Circuit Python from Adafruit's GitHub repository: [hsmag.cc/GwKXXY](https://github.com/hsmag/GwKXXY). Drag this .uf2 file onto HALLOWBOOT. This will install Circuit Python and automatically restart the HalloWing, renaming it CIRCUITPY. Note: Circuit Python 4.0 is currently in alpha release, so things may change as it develops. Welcome to the bleeding edge!

You'll also need the latest Circuit Python libraries for 4.x, available here: [hsmag.cc/xAHyST](https://github.com/hsmag/xAHyST). Since the HalloWing has plenty of space for it, it's easiest to drag the whole **lib** folder onto the CIRCUITPY drive.

In addition to libraries, this project uses four sounds and one image from our downloadable project pack: **meow\_01.wav**, **meow\_02.wav**, **meow\_03.wav**, **meow\_04.wav**, and **meowsynth.bmp**. Place these individual files onto the CIRCUITPY drive at the root level.

Although you can create and edit Circuit Python code with any text editor, it's best to use a code editor like Mu, which has helpful code-checking features and a REPL for debugging. In your editor of choice, create a text file called **code.py** on the CIRCUITPY drive. Now you're ready to code!

First, we'll import the libraries we need and set up the WAV files we'll be using in the code. This is where you can change the file names to other samples in the sample pack or your own recorded sounds.

```
import board
import audioio
import touchio
import pulseio
import displayio
import time

sound1 = open("meow_01.wav", "rb")
sound2 = open("meow_02.wav", "rb")
sound3 = open("meow_03.wav", "rb")
sound4 = open("meow_04.wav", "rb")

wav1 = audioio.WaveFile(sound1)
wav2 = audioio.WaveFile(sound2)
wav3 = audioio.WaveFile(sound3)
```

Next, we need to set up the capacitive touchpads as inputs, and create a variable for the capacitive touch threshold. This threshold value determines how sensitive the capacitive touchpads are – a higher value makes the pads less sensitive. Because there is a lot of exposed conductive thread running all around the glove, we found that we needed to set

this value fairly high. You'll need to tune this value for your particular glove.

```
capThreshold = 3500

TOUCH1 = touchio.TouchIn(board.A2)
TOUCH1.threshold = capThreshold
TOUCH2 = touchio.TouchIn(board.A3)
TOUCH2.threshold = capThreshold
TOUCH3 = touchio.TouchIn(board.A4)
TOUCH3.threshold = capThreshold
TOUCH4 = touchio.TouchIn(board.A5)
TOUCH4.threshold = capThreshold
```

Now, we'll add the speaker to A0 on the board, and set the TFT display to show our image. If you have a different image to show, update this section with your file name.

```
speaker = audioio.AudioOut(board.A0)

backlight = pulseio.PWMOut(board.TFT_BACKLIGHT)
splash = displayio.Group()
board.DISPLAY.show(splash)

with open("meowsynth.bmp", "rb") as f:
    odb = displayio.OnDiskBitmap(f)
    face = displayio.Sprite(odb, pixel_
    shader=displayio.ColorConverter(), position=(0,
    0))
    splash.append(face)
    board.DISPLAY.wait_for_frame()

for i in range(100):
    backlight.duty_cycle = i * (2 ** 15) //
    100
    time.sleep(0.01)
```

Our main loop consists of a four-part conditional statement. If any of the four capacitive touchpads are touched, the HalloWing will play one of the four sounds we loaded in the setup of our code. For good measure, we ask it to tell us in the serial monitor which sound it is playing. To keep the sounds clean, we ask it to **pass** while the sound is playing – it will not trigger another sound until the first sound stops.

```
while True:
    if TOUCH1.value:
        print("playing 1")
        speaker.play(wav1)
        while speaker.playing:
            pass
```

```
print("stopped")

elif TOUCH2.value:
    print("playing 2")
    speaker.play(wav2)
    while speaker.playing:
        pass
    print("stopped")

elif TOUCH3.value:
    print("playing 3")
    speaker.play(wav3)
    while speaker.playing:
        pass
    print("stopped")

elif TOUCH4.value:
    print("playing 4")
    speaker.play(wav4)
    while speaker.playing:
        pass
    print("stopped")
```

That's all there is to our code! Save this **code.py** file on your HalloWing, and the device will automatically restart and run the code. You should see the Meow Synth image fade in on the screen. Touch each capacitive pad (the gold 'teeth' at the bottom of the HalloWing) and make sure the sounds play correctly. For more information and help troubleshooting HalloWing, check out Adafruit's HalloWing guide at [hsmag.cc/OXwaRc](http://hsmag.cc/OXwaRc). When everything works, move on to building the glove!

## ATTACH THE COMPONENTS

Place the HalloWing on its spot on the glove, and sew it down with regular thread. There are four →

## YOU'LL NEED

- ◆ Adafruit HalloWing MO Express
- ◆ 8 Ω speaker with 1.25 mm 2-pin Molex PicoBlade connector
- ◆ 3.7 V 500 mAh or 400 mAh LiPo battery
- ◆ Glove
- ◆ Small piece of stretchy fabric
- ◆ Conductive prong-style metal studs or rivets and rivet tool
- ◆ Conductive thread
- ◆ Hand-sewing supplies
- ◆ Hot glue gun and glue sticks

**Below** ◆ Despite the advances of modern technology, sewing is still a great skill to have







**Above** ♦  
Be careful not to pierce the wire when stitching

mounting holes that are perfect for this. Stitch through each mounting hole, and tie off each separately with a tight knot. Be sure to avoid accidentally sewing through both sides of the glove when doing this.

Next, move your speaker into its location, winding the wire into a gentle spiral or curve if it is too long. The speaker doesn't have mounting holes, so use a little hot glue to hold it in place. Then whip-stitch the wire to the glove so that it won't catch on anything.

Now we need to make a pocket to hold the battery. Cut a small piece of four-way stretch fabric about 0.5 cm bigger than your battery on all sides. Trace the outline of your battery onto this fabric – this will be your stitching line. Pin this fabric in place

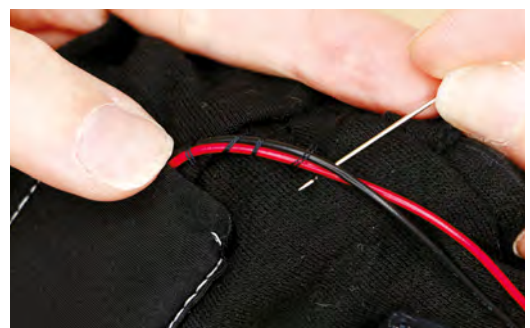
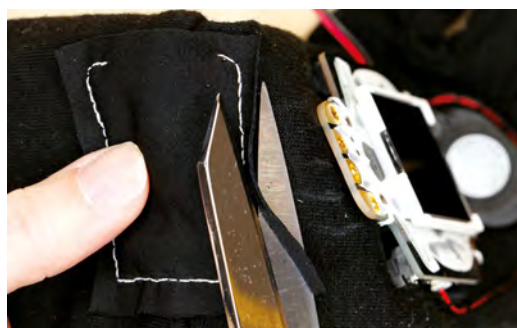
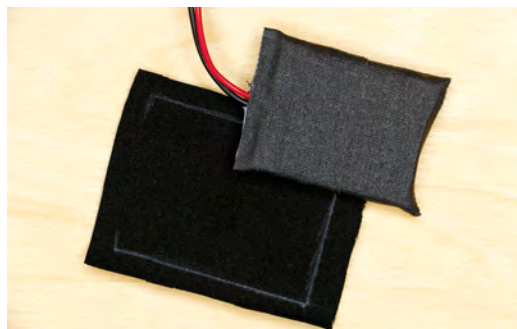
where your battery will go. Keep in mind which side of the battery your wires extend from and the path they will take to get to the HalloWing. Pin the fabric in place on the glove.

With regular thread, sew the battery pocket down along the line on three sides, leaving the fourth side open for the battery to slide in and out. A strong backstitch is a great choice for this seam. Sewing a few stitches beyond the two open corners helps keep the battery from falling out. Trim the edges of the fabric neatly.

Slide the battery into place, then sew down the battery wires with a whip-stitch. You're ready to switch to conductive thread and start sewing the rest of the circuit!

### SEW THE TRACES

Now that all the components are attached to the glove, it's time to sew traces to each finger tip. Thread your needle with a long piece of conductive thread (it will have to reach from the HalloWing to the tip of the finger). Start by sewing several tight stitches around one capacitive touch 'tooth' of the HalloWing, then continue to sew a running stitch along your drawn path toward the tip of the finger. When you start sewing on the underside of your glove, slip the glove on and continue sewing the trace while wearing it. Your glove is stretchy, but conductive thread does not stretch. Wearing



**Right** ♦  
A little care when assembling can make a big difference to the finished product

the glove while you sew will ensure that it still fits you once the trace is sewn, and you won't rip any stitches out when you try to put it on later.

When you get to the fingertip on the underside of the glove, sew several stitches over each other to make a tiny ball of conductive thread. Tie off your thread tightly, and cut the thread tail short.

Repeat this process for the other three capacitive touchpads on the HalloWing. Remember that none of your conductive thread traces can touch each other, or any other component in your glove. Trim thread tails short, especially at the capacitive touchpads where they are close together and are likely to touch. When all your traces are sewn, check to see if everything is connected correctly before moving on.



**Above**  Your sewn traces will be visible, so it helps if they follow smooth lines

**// To trigger the sounds on this glove, you'll need to create a capacitive point on the thumb as well**



Slip a piece of paper (or something non-conductive) inside your glove and turn it on. Touching the thread at the tip of each finger should trigger a sound.

### ADD CONDUCTIVE RIVETS

When you're happy with your sewn circuit, it's time to add rivets to the fingertips. The rivets make nice targets for you to aim for when triggering the sounds with your thumb. To apply the rivets, it's easiest to use a rivet fastener tool. Slip the concave 'anvil' of the tool into the fingertip under the thread ball. Place the rivet over the thread ball and push the prongs

**Below**  Don't sew the glove to your hand!



into the fibres of the glove. Align the rivet tool over the rivet and tap it a few times with a hammer to close the prongs of the rivet. Repeat this to apply a rivet to each finger.

To trigger the sounds on this glove, you'll need to create a capacitive point on the thumb as well. This will simply connect your thumb's conductivity to the outside of the glove so that touching any of the four fingers to your thumb will trigger a sound. With another piece of conductive thread, sew a thread ball at the tip of the thumb. Again, it's easiest to do this while wearing the glove on your non-dominant hand. Then, cover this thread ball with another rivet.

### INSULATE THE CIRCUIT

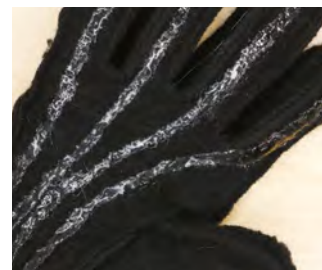
All that's left to do is to insulate the inside of the glove so that you can actually wear it without constantly triggering sounds. To do this, carefully turn your glove inside out. Do another check, using a multimeter if necessary, to make absolutely sure none of your traces are touching. Then, cover all traces with hot glue to insulate them on the inside of your glove. When the glue is dry, turn your glove right side out again, and you're ready to play sounds!

**Below**  A bit of hot glue keeps your touch sensors from constantly triggering



### MAKE MEOWS (AND MORE!)

Now it's time to play! Slip on your glove, switch it on, and touch your thumb to each finger to hear a different meow. Once built, it's easy to upload new sounds to your Handy Sampler. Record new sounds, save them onto the HalloWing, and update the file names at the top of your code. And you don't have to stop there: we've just touched the surface of what can be done with HalloWing. You could add a potentiometer for tuning your samples on the fly, or add some NeoPixels for a truly gig-worthy wearable. What will you add to your Handy Sampler glove? Show us at [hackspace@raspberrypi.org](mailto:hackspace@raspberrypi.org)!







FLY YOUR OWN  
CUSTOM DRONE

BUILD AN  
A.I. WATER CANNON

CONTROL YOUR HOME.  
SMART TECH YOUR WAY

& LOTS  
MORE

BUILD A  
TREBUCHET

MAKE MUSIC  
ON A SYNTH

**£12.99**

**FREE** WORLDWIDE SHIPPING

BUY TODAY AT  
[STORE.RPIPRESS.CC](http://STORE.RPIPRESS.CC)

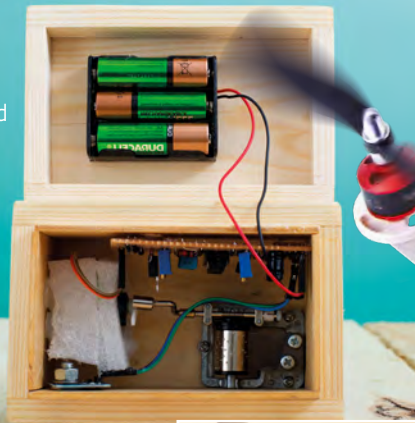
---

# THE BEST PROJECTS FROM HACKSPACE MAGAZINE

THE ULTIMATE SKILLS,  
TRICKS, AND MAKES

## MUSIC BOX

Build a touch-activated  
music box with no  
coding required



## BUILD A DRONE

The ultimate guide to making  
your own quadcopter



## LASER-CUT TURNTABLE

Create stunning 360° animated  
GIFs with this geared turntable



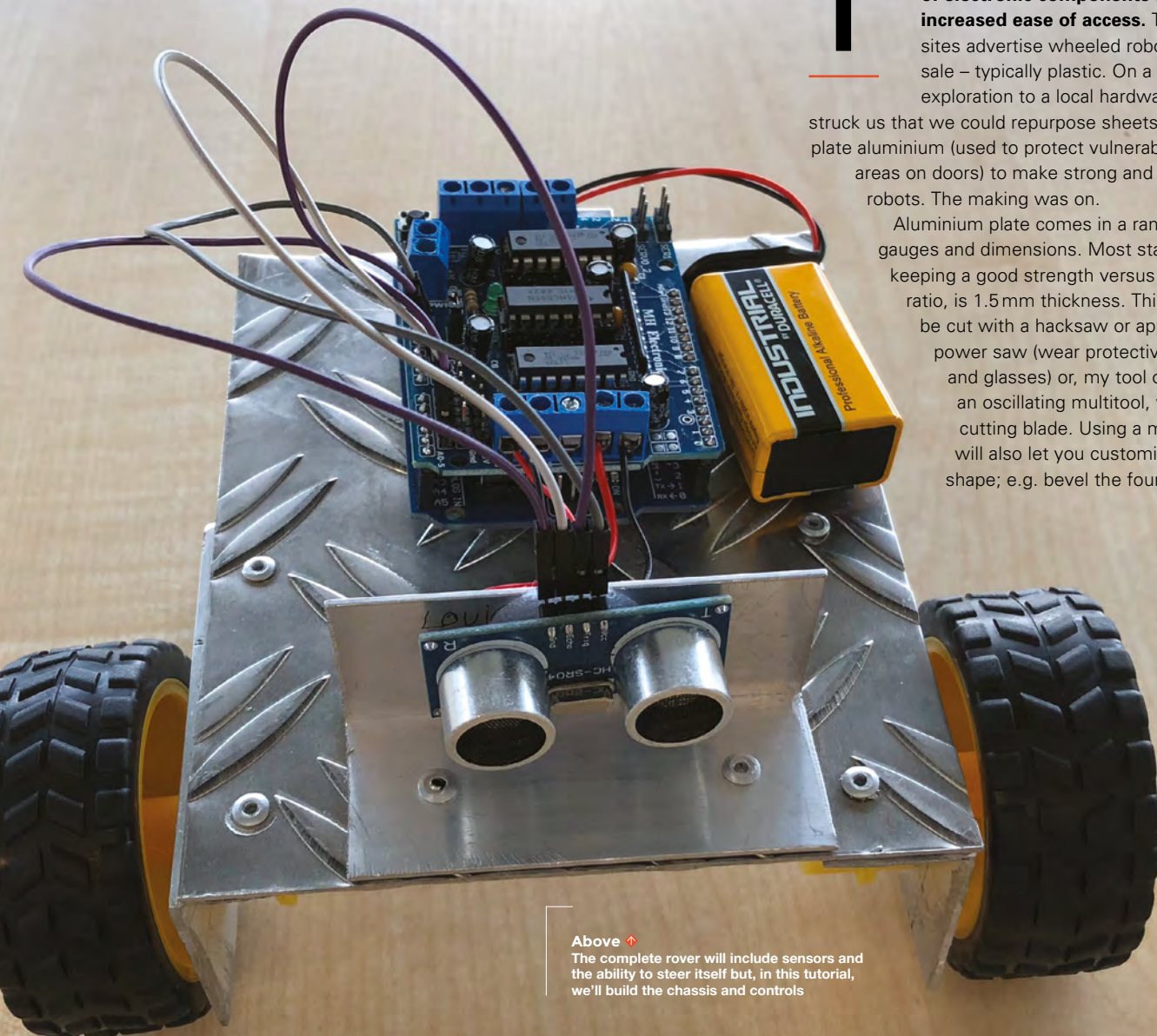


# Create an autonomous rover from scratch

Build a robot out of metal from your local hardware store

**T**he internet has reduced the cost of electronic components and increased ease of access. The usual sites advertise wheeled robot kits for sale – typically plastic. On a maker exploration to a local hardware store, it struck us that we could repurpose sheets of checker plate aluminium (used to protect vulnerable wooden areas on doors) to make strong and robust robots. The making was on.

Aluminium plate comes in a range of gauges and dimensions. Most stable, while keeping a good strength versus weight ratio, is 1.5mm thickness. This size can be cut with a hacksaw or appropriate power saw (wear protective gloves and glasses) or, my tool of the year, an oscillating multitool, with metal cutting blade. Using a multitool will also let you customise the shape; e.g. bevel the four corners.



Above ↗

The complete rover will include sensors and the ability to steer itself but, in this tutorial, we'll build the chassis and controls



**Michael Jones**

[hsmag.cc/ijfyXg](http://hsmag.cc/ijfyXg)

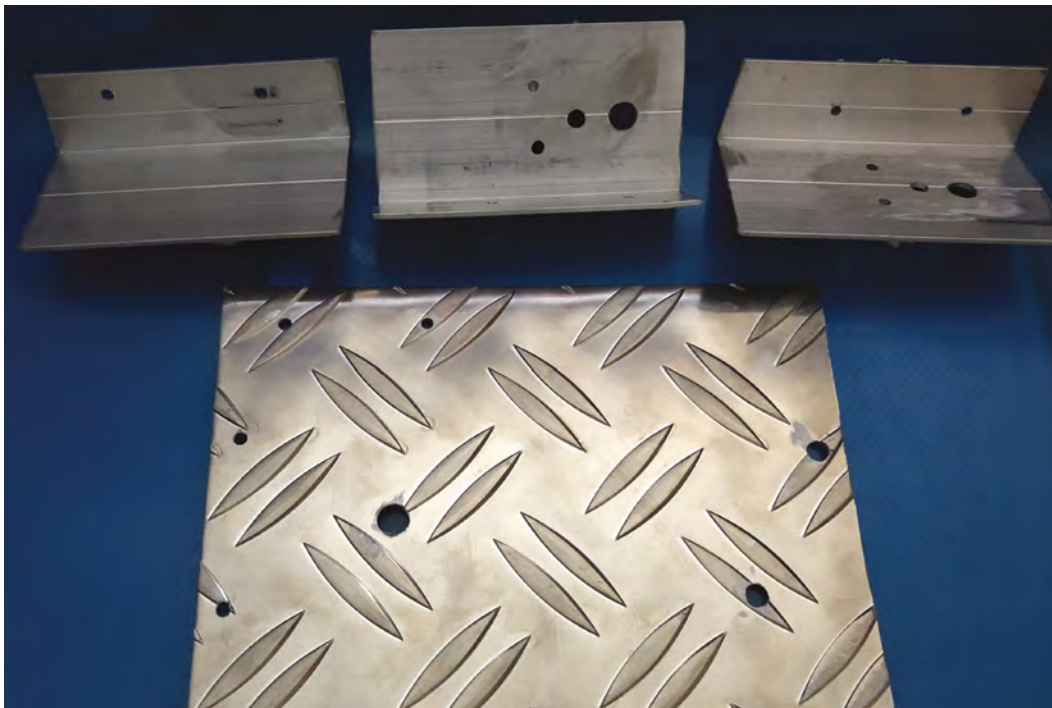
CS teacher in Kent, long-term CAS member and maker. Determined to turn abstract into practical, teaching videos.

**YOU'LL NEED**

- ◆ **Aluminium sheet and aluminium angle**
- ◆ **Two dual shaft hobby motors and two wheels**
- ◆ **40 mm castor wheel (salvage from old office furniture)**
- ◆ **Rivets and rivet gun (or M3 nuts and bolts)**
- ◆ **20 gauge wire, around 80 cm**
- ◆ **Battery adaptor and 9 V battery**
- ◆ **Arduino Uno and Arduino motor shield**
- ◆ **Velcro dots or strips (to fix the Uno to the chassis)**

**Above** The effort of your cutting and drilling: four aluminium parts

**Left** Journey's end – this is what you will create

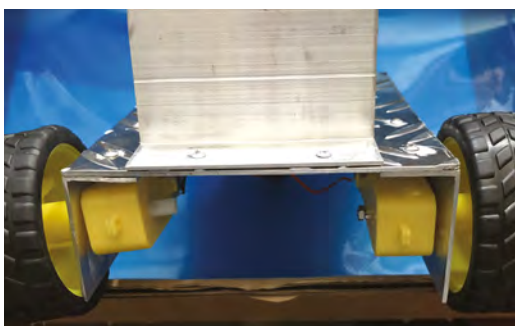


The minimum size for the main plate is 15×12 cm. You can go larger, especially if you want to mod up to four-wheel drive. Be mindful of your size. The motors used in this example are adequate for driving a vehicle of this size. If modding the motors, ensure you have compatible wheel motor shafts.

Sawing metal will leave burrs that can be sharp. Remove these with a file or sandpaper on all your cuts to avoid injury.

**CUT TO SIZE**

The next step is to cut the aluminium angle into three equal lengths. This prepares the sides and the sensor bar (which we'll cover in part 2, next issue). The metal sides add protection to your motors by effectively enclosing them. An optional modification, at this stage, would be to extend the length of the side part to match the length of your plate. This would be useful if you want to create a four-wheel-drive robot.



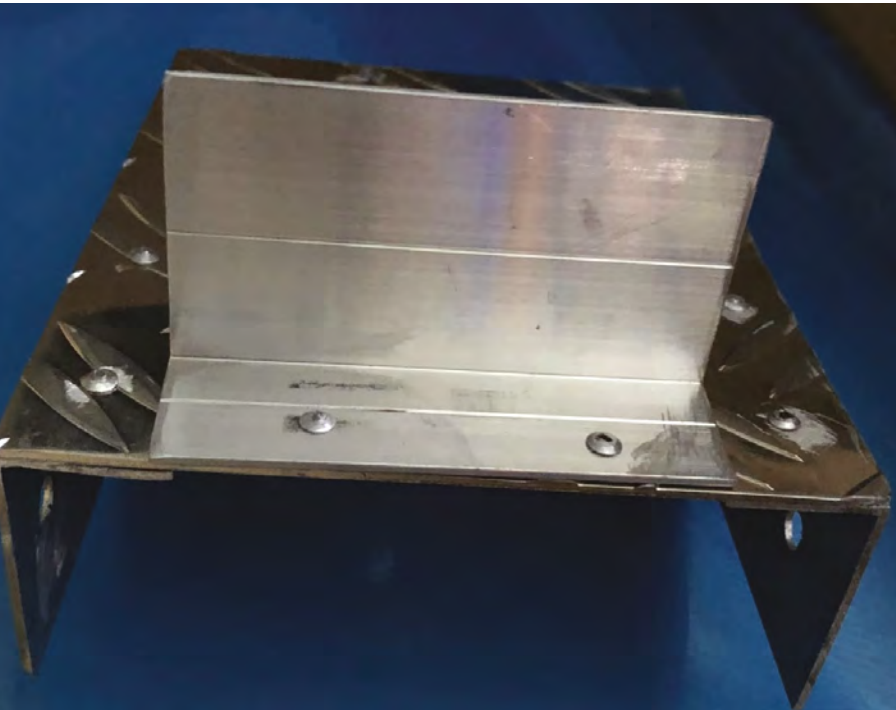
**MEASURE THRICE - DRILL ONCE!**

You can adjust the chassis design if you want, but do ensure the weight is distributed evenly and the parts will fit. At the front of the plate, drill four holes (two on either side) suitable to accept your size rivets. The holes should be placed 1.5 cm and 5 cm from the front, 5–10 mm in from the side. These will be the fixing points for the side panels. You can remove the need for riveting by using small nuts and bolts. If using nuts and bolts to fix, anywhere from M2–M3 (1.9–2.9 mm) will do the job.

Now drill the metal plate to receive the motor wires. The hole should be large enough to thread four wires (or eight if you're going to make your →







**Above** ♦  
The result of your effort so far – a robust metal chassis

### QUICK TIP

The nature of the motors is such that you may find one is slightly faster than the other. Adjust speed up or down to match.

### USB LINK

If you are not sure which COM port, or Mac equivalent is being used, unplug your USB while viewing the Ports list in the Arduino IDE. If it disappears, that is your port.

bot four-wheel drive). Drill size between 8 and 10mm will be adequate.

Drill the hole in the middle of the plate, no less than 40mm from the front.

Drill two holes, 40mm from the left- and right-hand sides. Match the holes to your front angle aluminium. The easiest way to do this is to place the angle aluminium over the holes, in the middle of the plate, and mark the drill points. Fix the front angle aluminium to the top of the plate. Position it in the middle. As with the sides, use rivets or replace with nuts and bolts.

The castor wheel fits on the back of the chassis to aid movement. Using the castor fixing plate as your template, mark the position of two drill holes (you will not need to fix at all four points), and drill. Check that your holes line up. Sand/file all holes to remove burrs and edges.

### PRECISION NEEDED

Time to drill the angle aluminium for the motors. You will notice that each motor has two small holes through the motor casing. These enable you to fix the motor to the chassis. You will also require a hole for the motor shaft, and a small raised area.

From the outside edge of one hole to the outside edge of the other should be a span of 20mm. Measure carefully, mark the plate, and drill. You may find it useful to place a strip of masking tape on the metal, to prevent drill skid.

The small raised area is normally in the middle of the motor casing, around 20mm from one end.

Check your motor (different batches have slightly different mouldings). When happy, drill and check. Now onto the hole for the motor shaft. The centre for this is usually 10mm from the end, and in the middle of the casing. A 5mm hole would be best. Once the holes have been deburred, check that the motor fits – not too snug and not too loose. Check that the bolts go through the motor casing and into the angle plate. Repeat for the second motor (and third and fourth if you're opting for four-wheel drive).

Having checked that the metal parts match, fix the three angles and the castor to the metal plate. Well done! You have your body made.

### ONTO THE ELECTRICS

Most motors usually come without wire attached to the motor terminals. Look closely at the terminals. You should see a small metal strip – one for each motor wire. Cut your wire into four pieces – ideally you'll use different colours for each wire from each motor, as this can make it easier to see what's going on, but this isn't essential.

Strip the wire back at both ends so that you have enough to fix to the motor shield and motor terminal, and solder them on. Attach the motors to the chassis, and thread the wires through the hole in the chassis plate.

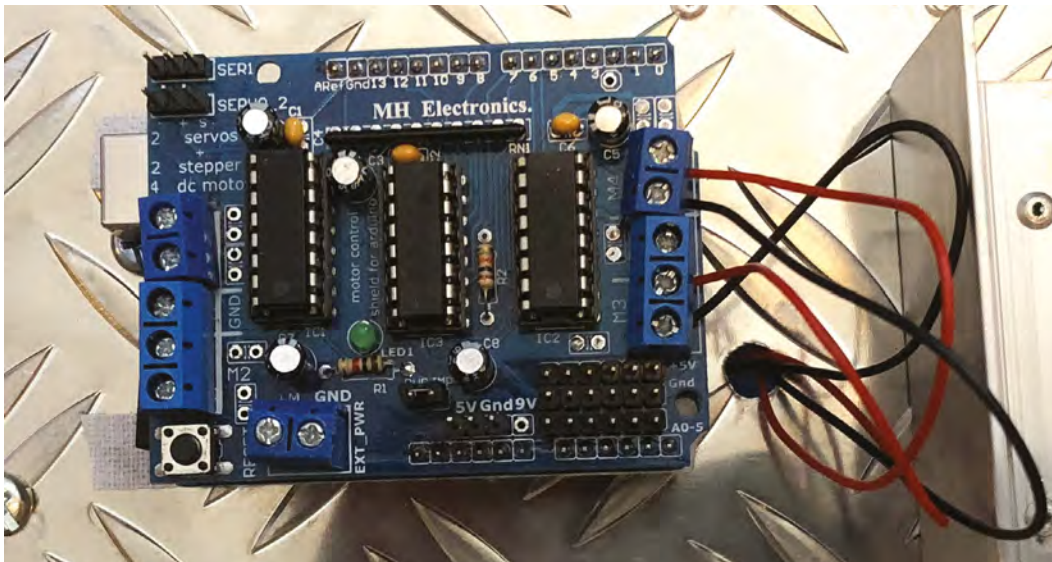
There are two options for powering motors – either via the Arduino or via an external power source. Most motor shields give you the option to select between them (usually by setting a jumper). Check the documentation on your motor shield for how to control this, but we'll start by powering ours via the Arduino. If you don't have this option on your motor shield, you could always take the power from the Vin and GND pins on the Arduino to the power-in on the motor shield.


Fit the motor shield to the Arduino. Fit the motor wires to motor terminals 3 and 4.

Plug your Arduino USB lead into the board and then computer. Check that Uno (or other Arduino board) is selected and your COM port is showing.

Now let's run a simple test script to see if everything is set up correctly. The code is:

```
#include <AFMotor.h>
AF_DCMotor motor3(3, MOTOR34_1KHZ);
AF_DCMotor motor4(4, MOTOR34_1KHZ);
void setup() {
  motor3.setSpeed(200);
  motor4.setSpeed(200);
}
void loop() {
```



**Left**  Don't worry that you do not know the positive or negative terminals yet – this can be fixed in the software, or by switching the wires

```
motor3.run(FORWARD);
delay(1000);
motor3.run(BACKWARD);
delay(1000);
motor3.run(RELEASE);
delay(1000);
}
```

```
motor3.run(BACKWARD);
motor4.run(BACKWARD);
delay(2000);
motor3.run(FORWARD);
motor4.run(FORWARD);
delay(2000);
}
```

You can enter this via the Arduino IDE and upload it as normal. If you've not used an Arduino before, you can follow the instructions for getting started at: [hsmag.cc/aQVsCW](http://hsmag.cc/aQVsCW).


In this code, we've created two objects, **motor3** and **motor4**, that refer to our two motors. As you can see, this code just runs **motor3** in the loop, as it's easier to test one motor at a time. Once you've made sure this motor is running correctly, change the references to **motor3** in the **loop()** to **motor4**, and the other one should run.

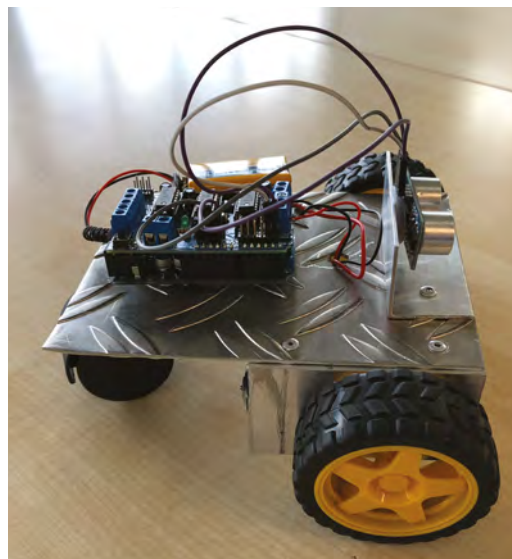
We can also run both motors at the same time. At this point, let's untether the robot from the computer; so, once the code is uploaded, unplug the Arduino's USB connection from your computer, and plug in the 9V battery using its adapter. This will let you run the bot without the computer.

The following code should let you move forwards and backwards:

```
#include <AFMotor.h>
AF_DCMotor motor3(3, MOTOR34_1KHZ);
AF_DCMotor motor4(4, MOTOR34_1KHZ);
void setup() {
  motor3.setSpeed(150);
  motor4.setSpeed(150);
}
void loop() {
```

If your robot spins, rather than moving forwards and backwards, it means that one motor is wired up differently to the other. You'll need to work out which one is correct and, for the other one, reverse **FORWARD** and **BACKWARD**.

That's the basic hardware completed for our Arduino robot. Next issue, we'll take a look at how to expand its capabilities with some sensors. 



**QUICK TIP**  
Ensure you have the motor driver library installed by following the guide: [hsmag.cc/vZnIVw](http://hsmag.cc/vZnIVw). The library we used is 'motor shield v1'.

**Left**  You can modify the code to get the rover to drive in whatever pattern you like

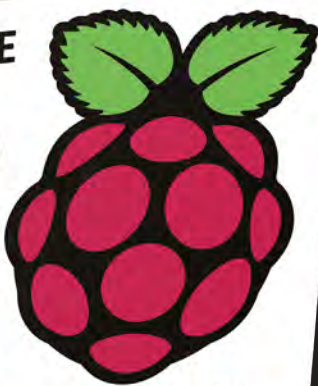


DON'T MISS THE **BRAND NEW** ISSUE!



YOUR **OFFICIAL** RASPBERRY PI MAGAZINE

# The **MagPi**



The official Raspberry Pi magazine

Issue 76 | December 2018 | [magpi.cc](http://magpi.cc)

**NEW**  
FOR  
**2019**

## THE RASPBERRY PI **SUPERGUIDE**

• Get going guide • Starter projects • Tech jargon busted

**Code Pac-Man**  
Make your own retro ghost-chaser



**SUBSCRIBE FROM JUST £5**

- **FREE!** 3 issues for the price of one
- **FREE!** Delivery to your door
- **NO OBLIGATION!** Leave any time

**WIN!**  
10 *Signed*  
**3A+**



**PLUS! FREE CASE, THREE COVERS & CABLES**

**FREE PI ZERO W**  
With your 12-month subscription to the print magazine  
[magpi.cc/12months](http://magpi.cc/12months)

**Buy online: [store.rpipress.cc](http://store.rpipress.cc)**



# FIELD TEST

HACK | MAKE | BUILD | CREATE

Hacker gear poked, prodded, taken apart, and investigated

PG  
110

## DIRECT FROM SHENZHEN: POWER SUPPLY

A bench power supply for configurable electricity in your projects

PG  
118

## CAN I HACK IT?



What do you find when you pull an LED projector to pieces?

## REVIEWS

120 **Raspberry Pi 3A+**  
A new teeny computer

122 **TS 100**  
A hackable soldering iron

124 **Weekend woodworker**  
Learn to make in your spare time

PG  
112

## BEST OF BREED

Alternative conductors: Fabric, ribbon, rubber, and even glass put to the test



126 **SpeedCutter**  
Efficient sawdust production

128 **MonkMakesDuino**  
A breadboardable microcontroller

129 **HPMOR**  
Fanfic for learning to think



DIRECT FROM  
SHENZHEN

# Bench power supply

A source of electrons for your projects

By Ben Everard

 @ben\_everard

**S**upplying power to your projects sounds like a pretty simple task, but can be surprisingly complex. The first and most important thing is how much power you need. If you're dealing with simple electronics, just a few volts and

a few hundred milliamps may be enough, and if it is, you may find that the built-in regulator on your microcontroller can supply enough current (which probably comes via USB). However, some projects need a little more oomph.

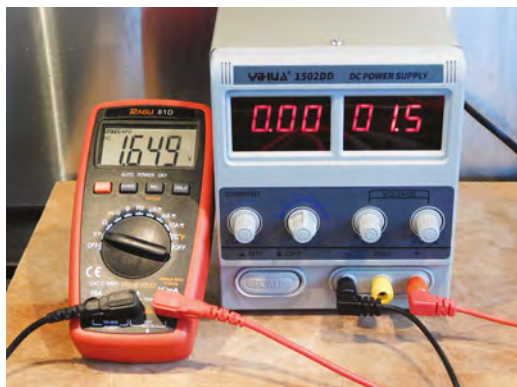
There's a myriad of options for getting power into your projects, including batteries and 'wall wart' style plugs – these are all great when you've got your project working, but for prototyping they can leave a little to be desired. That's where the bench power supply comes in. These are specifically for experimenting with bits of your project, rather than running the final thing.

We got a YIHUA 1502DD Mini Laboratory Power Supply for £32.16 from JZLTool Store on AliExpress. It can output up to 15V at up to 2A. There are three connections on the front: positive, neutral, and ground. The last two aren't interchangeable. The neutral connects back to the power supply, so should be used for completing the circuit. The ground should be connected through to the mains ground that the power supply is plugged into. However, as we don't have a mains ground on the supplied plug, this connection doesn't make sense. Upon opening it up, we found that it was connected to the metal chassis (as you'd expect); however, as the metal chassis wasn't grounded, it's left floating.

**Left**

15V and 2A is enough for most basic uses, but you might need a more powerful supply if you're trying to build something more advanced





#### Above

The voltage output on the power supply shouldn't be trusted, but can be varied to your desired voltage

This isn't a huge problem for many basic uses, but it's infuriating to have a connection that doesn't work, and would cause problems if you were trying to use it.

This does hint at a bigger problem – that the power supply isn't grounded. It's not essential that any mains-powered device is grounded. However, if it isn't, it needs to be properly protected to prevent accidental electrocution (this isn't just good practice – it's the law that all items sold in the UK do). What we have here



**As a rough rule of thumb, the more you're interacting with the real world, the more power you're going to need**



is a metal case, with no additional insulation, that's not grounded. It's not dangerous now, but if anything were to go wrong inside that pulled a live wire loose, it would be easy for the whole box to become live.

This is easy to fix – a proper three-core flex could be added, and the box grounded, but it's not the sort of thing a manufacturer should expect a user to do.

Let's get back to looking at the other features. As with most bench power supplies, there are readouts showing the voltage and current being supplied. These are shown to two decimal places, but they don't seem to be anywhere near this accurate. This isn't a huge problem, as we'd recommend checking bench power supply readings using a multimeter anyway.

Perhaps the biggest advantage of a bench power supply over a regular power supply is the ability to run at a constant current as opposed to a constant voltage. In this setup, you set a voltage and a maximum current. The power supply will provide power at this voltage unless the current threshold is reached. At this


point, constant current mode kicks in and it adjusts the voltage so that too much current is never supplied.

Our bench power supply does have this, but the lowest current it can limit to is 0.6A (it's adjustable up to 2A). This will help with things like not burning out motors, and not blowing the power supply, but it's far too high to protect delicate electronics components.

### CROSS-BORDER CONUNDRUMS

This power supply shows the problems of buying non-reputable products from overseas. Anything sold in the UK or EU is required by law to follow high-standard safety protocols (other countries vary).

We want to be clear here – the problem isn't that it's made in China, since much high-quality hardware is manufactured there. The problem is that it's bargain-basement hardware that's not associated with a reputable brand, sold across borders in a way that dodges regulatory compliance. In many cases, this isn't a problem – a box of LEDs may or may not be good and accurate to their description, but they're unlikely to cause a safety hazard in prototyped electronics. However, in safety-critical hardware (and anything mains-powered is safety critical), you either need to be confident enough in your own abilities to render something safe, or buy from a supplier that you're confident is safe.

This power supply has absolutely no bells or whistles. There's a single channel (it can only output one voltage at a time), there's no ability to control or monitor it remotely, or other features that more expensive power supplies offer. If it were simply properly earthed then we'd be happy to recommend it as an entry-level power supply. However, as it stands, we simply can't recommend a product that potentially puts users at risk. 

DIRECT FROM SHENZHEN

#### Below

Beware of fake earth connections





ONLY THE BEST

# Other conductors

Ditch the wire and build your circuits with more exotic materials

By Marc de Vinck

@devinck

**C**onductive materials may seem like an odd topic for a Best of Breed article, but these are no ordinary conductive materials. We won't be looking at common conductors like wire – although, believe it or not, there are some interesting wires out there – but instead we will be looking at some unusually conductive materials. Some may call them smart materials, but we think that is a bit of a stretch, since none is particularly smart.

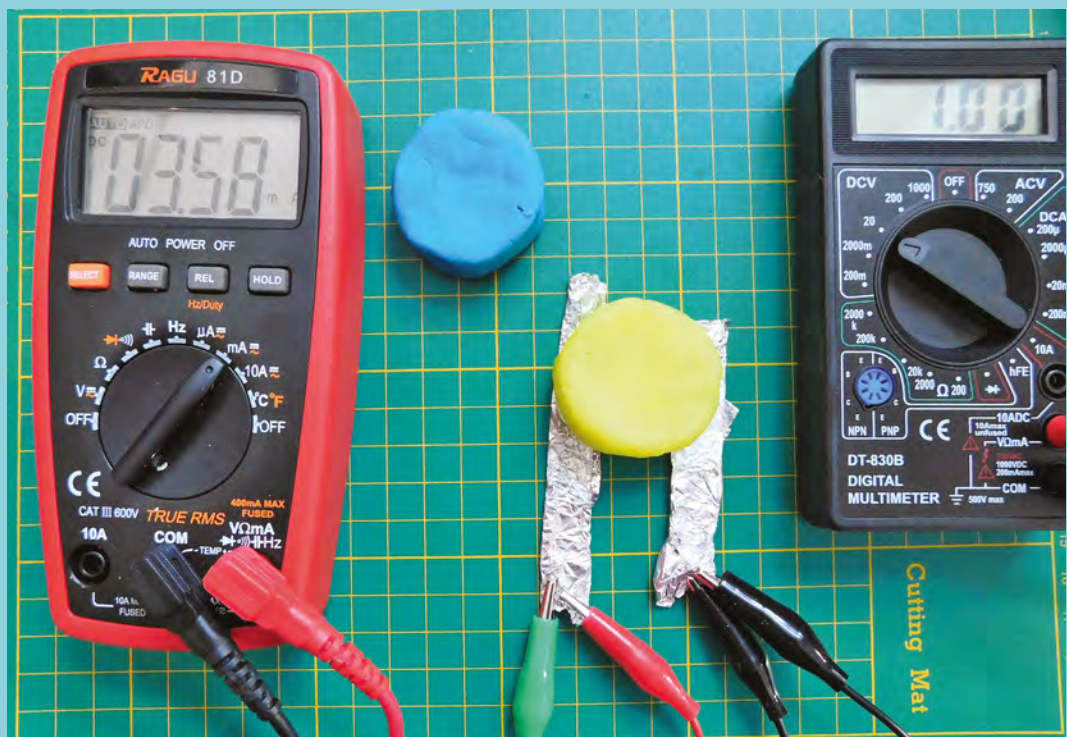
There are a lot of materials out there that you wouldn't think are conductive, for instance glass. Yes, there is conductive glass. And no spoilers, but it's pretty cool! A lot of new conductive materials have come from the development of smart clothing. You may have seen gloves that you can wear and still control your smartphone. How? It's usually some conductive thread or fabric that makes the electrical connection between your finger and the phone's screen.

We've also seen some interesting projects and products that rely on capacitive touch to control them. Sometimes it's as simple as a hidden antenna under a

thin material, and other times it's actually a piece of conductive plastic making the electrical connection. The future is going to be fascinating as more and more conductive materials are developed and used in our everyday products.

In this Best of Breed, we'll be looking at a few of our favourite, less common, and more innovative, conductive materials. There are a lot of them out there, and we certainly don't cover them all. Hopefully this will inspire you to think about how you could use these materials in your next project. □

**Below** ▣ For another look at alternative conductors, check out our play-dough tutorial on page 82



# Electric paint vs conductive ink pen

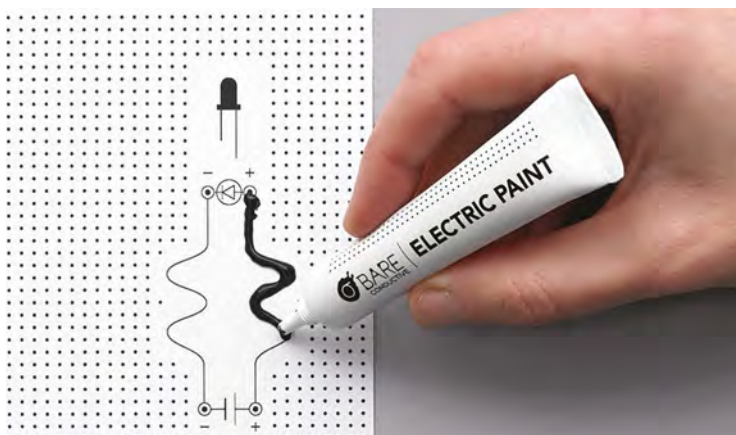
Draw your own circuits

**BARE CONDUCTIVE** ◆ \$8.40 | [bareconductive.com](http://bareconductive.com)

**CIRCUIT SCRIBE** ◆ \$9.99 | [circuitscribe.com](http://circuitscribe.com)

**E**lectric paint is an interesting name for an interesting product. Use it like a pen to draw with conductive paint, making circuits along the way. The paint is not that smooth, but it works well. It can be tricky to get a perfect line, but it works really well with a stencil, like silk-screening, and is available in bulk sizes.

In addition to making electrical connections with this ink-like paint, you can use it as a glue. There are lots of conductive materials that you can't reliably solder to, and that's where this little paint pen may come in handy. Use it to connect LEDs to conductive fabric,



**Left** ◆ Not as simple as a pen to use, but it works well

**Below** ▣ An easy and very familiar way to write with conductive ink

or as a glue on ITO glass. Not sure what ITO glass is? Keep reading! We've really enjoyed using this product on several occasions, and always have a supply ready to go if the need arises. ▣



**T**he Circuit Scribe is a little more refined an instrument, compared with the Bare Conductive paint dispenser. It has a comfortable feel, similar to a regular pen. But this is no ordinary pen!

The ink in the Circuit Scribe pen is conductive. This allows you to draw electrical connections, just like you would write a letter.

It's no replacement for wires, but it's really fun. You can even solder to the ink, although even Circuit Scribe admits it's a bit tricky. The company also offers a host of accessories for making interactive circuits, including motor add-ons, switches, LEDs, and a lot more. Head over to the firm's website to see all the things you can make with conductive ink. ▣

## VERDICT

Electric Paint by Bare Conductive

Works really well and can double as a conductive glue.

9/10

Circuit Scribe conductive ink pen

Simple to use, in a familiar form factor.

9/10



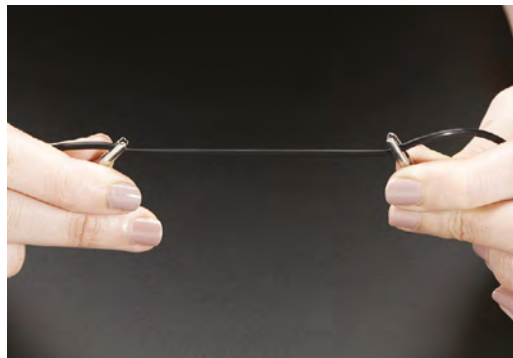
# Conductive rubber cord stretch sensor

When circuits need to stretch

ADAFRUIT  \$9.95 | [adafruit.com](https://adafruit.com)

**M**easuring how much force is applied in a stretching motion is no trivial task, but it's an incredibly useful measurement, especially when it comes to wearable devices. That's where conductive rubber cord comes into play. In its relaxed state, the rubber cords resistance is about 350 ohms per inch. As you stretch it, the resistance increases as the particles embedded in the rubber become further apart.

You can only stretch the rubber 50–70% longer than the initial resting length, so a piece that is about six inches long shouldn't be stretched to more



than ten inches. Just keep in mind that it will take a minute or so for the rubber cord to recover from being stretched. □

Left 

As you stretch this rubber cord, the resistance increases


## VERDICT

A unique conductive material that is surprisingly useful.

9/10

# Conductive thread

Not all thread is born equal

SPARKFUN  \$41.95 | [sparkfun.com](https://sparkfun.com)

**W**hen you plan on making a lot of soft circuits or wearables, this spool of 360 yards of conductive thread is for you.

Unlike silver-plated thread, this is actually spun from stainless steel fibres and does not have a nylon core. You can solder to it, but it's a little tricky since it is stainless steel. However, since it doesn't have a nylon core, like some other conductive threads, it won't burn up at just the sight of a soldering iron. SparkFun suggests

that if you decide to hand-sew with it, you should apply a little wax to minimise the 'hairy' nature of the thread, reducing the chance of shorts. □



Below 

360 yards of conductive thread

## VERDICT

Bulk thread for big projects.

8/10

# 8331 Silver conductive adhesive

Like solder, but without the heat

MGCHEMICALS ◆ \$14+ | mgchemicals.com

**8** 331 is similar to most two-part epoxies, but this product from MG Chemicals is formulated with an electrically conductive mixture of silver. Having experimented with this product on several builds, we can tell you that it works well, and it's something you should have on-hand in your prototyping lab.

Not only can you attach wires easily when soldering is impossible, but it makes for a great way to fix traces on old PCBs, or other repairs where bonding and conductivity is essential. It can also be used in conjunction with products where soldering



**Left** ◆  
A very strong two-part conductive epoxy adhesive ink

**VERDICT**  
Makes a very secure and conductive connection.

**9**/10

isn't an option, like ITO glass, or conductive fabrics. 8331 has a very low resistance, at only 0.007 ohms per cm, which makes it very useful in a broad range of projects. □

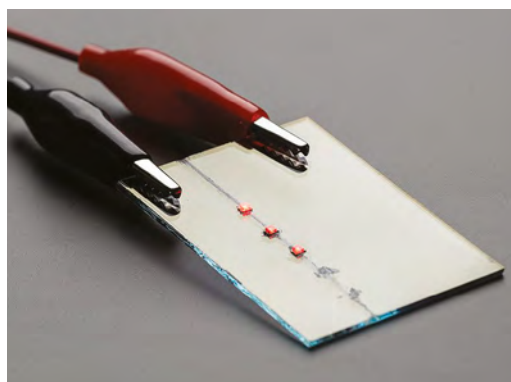
# Indium tin oxide coated glass

See-through electronics

ADAFRUIT ◆ \$5.95 | adafruit.com

**0** K, the name may be a little misleading, since it's not really the glass that is conductive, but rather the indium tin oxide (ITO) coating on the glass. In any event, this is one of our favourite products in this Best of Breed. The magic of this conductive glass is the fact that ITO is clear and it's conductive, which allows you to make some really amazing-looking circuits.

By coating the glass with the indium tin oxide, you get a completely transparent, yet conductive, surface. By scratching lines into the surface, you can create what are very similar to traces on PCB. Keep in mind, you can't solder to ITO glass, but you can



**Left** ◆  
Conductive glass. Yes, it's a thing

**VERDICT**  
A unique conductive material.

**10**/10

use conductive glues, tapes, and other adhesives to create circuits with ITO glass. ITO glass has a resistance of 10–15 ohms per square inch, which isn't too high, making it ideal for components like LEDs. □




## Conductive fibres

The building blocks of fabric

ADAFRUIT  \$2.95 | [adafruit.com](https://adafruit.com)

**T**his conductive fibre is unique, as it's perfect for needle felting or making your own conductive yarn. Adafruit has tested many different fibre thicknesses for needle felting and it found that 20µm fibre thickness was the most successful and easiest to use. Now you can make custom felt game controllers, soft buttons, or add this to your next knitted project. And you aren't limited to only making electrical connections: you can also use this fibre to make your own squeeze or pressure sensors, as the fibre becomes less resistive the more you squeeze them together. □



**Left**  You can even try your hand at conductive needle felting with this unique fibre

**Credit**  
Adafruit

### VERDICT

An inexpensive and interesting fibre.

**8**/10


## Conductive hook and loop tape

Removable electronics

ADAFRUIT  \$5.95 | [adafruit.com](https://adafruit.com)

**Y**es, there is even conductive Velcro hook and loop tape. This is really useful stuff, especially for any type of wearable. It really couldn't be easier to sew a thread to each side, and make a simple switch. This was originally used to make static-safe clothing, but we think many hobbyists will find much more interesting uses for this hook and loop tape. □



**Right**  Make your own switch with hook and loop tape

### VERDICT

Simple to use and works well.

**8**/10

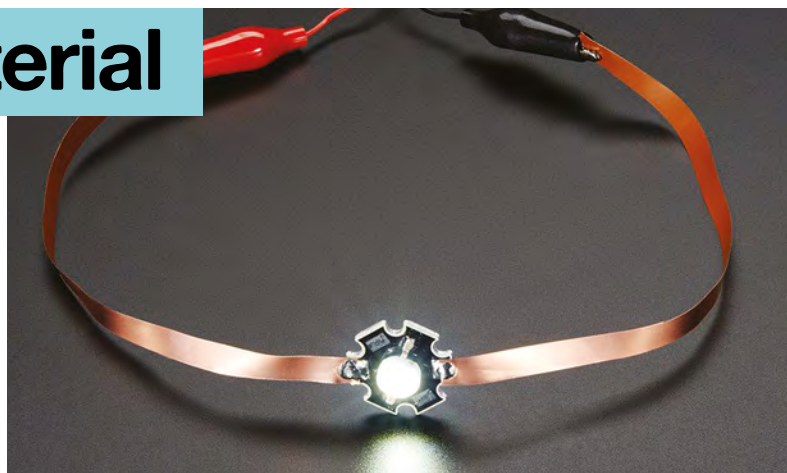
# Flex PCB material

Bendy boards

ADAFRUIT ◆ \$8.95 | adafruit.com

**I**f you have ever ripped open an electronic device, specifically a wearable device or cell phone, you might have come across some interesting flexible printed circuit boards (PCBs). Normally, this is a technology that isn't particularly easy to have manufactured or get your hands on.

Adafruit sells sheets of Pyralux, which is DuPont's flexible PCB material. You can treat it just like any other PCB and etch circuit traces into it, or solder components directly to it, since it has a nice copper layer. It's a really interesting, and durable, material that might even make a great substitute for more fragile copper foil tape. □



## VERDICT

Now you can make simple flexible circuit boards at home.

**10**/<sub>10</sub>

### Above ◆

You can etch, or simply cut, this flexible PCB material to make unique circuits

## BEST OF THE REST

Pressure-sensitive conductive sheet

\$3.95

adafruit.com

A little finicky, but gets the job done

Proto-Pasta Conductive PLA

\$49.99

matterhackers.com

Conductive PLA is amazing, just don't expect it to replace a circuit board

Copper Tape from SparkFun

\$14.95

sparkfun.com

Works well and is very conductive

3M Z-Axis Conductive Tape

\$4.95

adafruit.com

Very unique conductive characteristics

# Conductive ribbon

Three wires, one ribbon

SPARKFUN ◆ \$5.95 | sparkfun.com

**T**his is no ordinary conductive ribbon; this stuff has a secret. This ribbon has three different conductors sewn into it. This makes it really handy for hooking up a variety of different three-wire sensors (power, ground, and signal) for your next wearable project. It has very little resistance, at about 0.3 ohms per metre, and comes in one-yard strips. You can even solder to the conductors, which is really useful when attaching them to a microcontroller or other device. □



## VERDICT

Save a little time with this pre-made conductive ribbon.

**9**/<sub>10</sub>

### Above ◆

This ribbon has three different conductors ready to be hooked up



## Can I Hack It?

# A projector?

Celebrate in style with ultra-bright LEDs!



Les Pounder

@biglesp

Les Pounder loves taking things to pieces and seeing how they work. He teaches others as part of the Raspberry Pi Foundation's Picademy event. He blogs over at [bigl.es](http://bigl.es)

### YOU'LL NEED

Xmas decorative projector lights outdoor, **ONEVER LED Christmas**

### COST

£20.00

### WHERE

[hsmag.cc/mHTjws](http://hsmag.cc/mHTjws)

### Right

The projector can be secured to a wall using the screw plate, or it can be staked into the ground using the detachable spike

**T**he first ever item that we tore down in HackSpace magazine was a dancing Christmas tree and, as we write this latest edition, our minds wander to the festive season, which is only weeks away. In recent years,

homes around the world have prepared for Christmas in even more outlandish ways – and surely the most brash and unashamed manner is to project Christmas all over your home using an outdoor projector. But, how do they work, and what can we do with one? Well, there is only one way to find out: we need to take one apart!

### PULL IT TO PIECES

The projector is made of a workable plastic, and comes in a series of sections. For example, the lens section is held on with four large cross-head screws. When removing the lens section, we discovered that the lens is real glass, and that the lens is secured over the projection plate with a water-resistant cover, helping to restrict water ingress. Where the power lead comes into the projector, we see a gland that covers the hole for the wire, and protects the unit from water. There's no rubber seal however, so be careful!

The unit is held together using a mixture of hex screws and cross-head screws. The hex screws are used to cover an access slot where we can insert 'cartridges' containing the images to project. Inside the projector, there are multiple cross-

head screws, of different sizes. The smallest hold a blanking plate over the LED lenses, to prevent light leakage. The thickest are those that hold the motor and LED PCB to the projector chassis. Just be careful with these screws, as they are really close to the power wires for the motor!

The images projected are made possible using a selection of cartridge slides that contain four images based on seasons/events or celebrations. These cartridges measure 65mm by 45mm, by 3mm thick, and are made of the same plastic as the projector. They can be carefully taken apart to

find inside two small lengths of plastic film, with the images printed upon them.

Why is this important? Well, using a good-quality printer and some OHP (overhead projector, remember those from school?) transparency sheets, we can print our own images! Trial and error will be required, but the cost of the sheets is negligible.

### MAXIMUM POWER

In the box we find a 12V 300mA mains power supply, which provides 3.6W of power, slightly less than the rated 4W, but enough. The power supply connects to the projector via a 4.8 metre power cable, and it uses a screw thread and polarised connector to ensure correct polarity and for a secure connection. This also provides some water resistance as it is rated IP44 (typical for bathroom electronics)



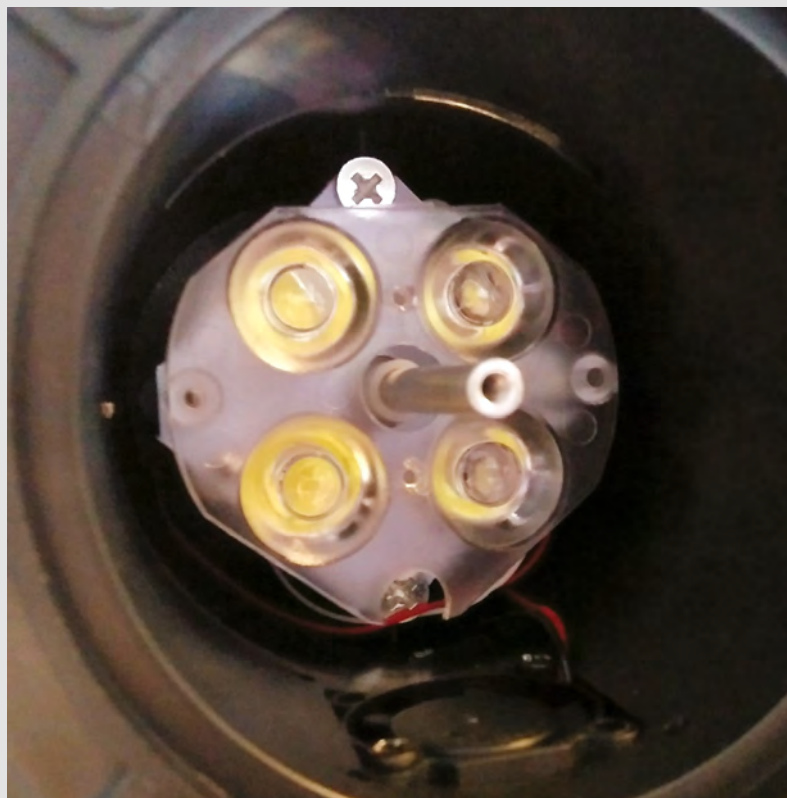
## SHINE THE LIGHT

Projectors are extremely simple devices; light is shone through the object that you wish to see, in this case the images from the cartridges. This is then shone through the lens, magnified, and finally projected onto the wall. This means that they have very few electronics inside of them. There are many more projector technologies, and some of the latest use lasers! Yup, we can now fire lasers at our home. These projectors are not like the one which we tore down; rather, the lasers project the shapes using wireframe.

You can also find cheap HDMI projectors – typically restricted to around 800x480 resolution, but they will scale down a 1080p signal – for around \$70 on Amazon. These projectors also use LEDs to project the video/image. Because of their low power they need almost total darkness to work, but they're cheap, and easy to modify, so we're sure that someone out there can hack them into a useful project!

that might get sprayed), but do not rely on this rating for outdoor use. Ensure that the plug is connected to the mains via a fully rated and waterproof outdoor connection.

Sadly, we can't run the projector from a USB 5V supply, as there's not enough power. But if we use a 5V to 12V step-up voltage transformer, typically USB to DC barrel jack, then we can power the unit from a USB battery for ultimate portability! The USB output will need to be over 2A, with 2.4A being the sweet spot. Typically, these step-up transformers can supply up to 12V 800mA, over double the requirements of our projector! If you 'roll your own' power supply, do ensure that it is safe and it exceeds the current demands of the projector.



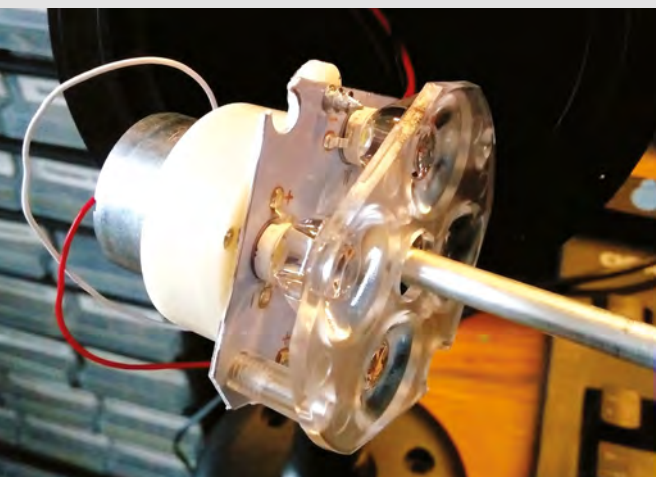
## COMPONENT PARTS

At the lens end of the projector we have a small fan that is there to keep the unit cool, but is nowhere near the LEDs that project the light. As for the LEDs, we have four 1W LEDs, commonly used in torches (aka flashlights for our American readers). These LEDs are focused through a thick lens, and this gives us the best beam of light possible for the projector. To rotate the inner lens used to magnify the projected images, we see a low-speed, high-torque DC motor. The motor and LEDs are directly connected to the power, and there are no other electronics in place to control the projector. But, for those of us with the equipment, we could easily sneak in a Raspberry Pi, Arduino, or ESP32, and the appropriate buck converter (LM2596 to drop 12V to 5V for the boards) and motor controller (L298N would be ideal), so that we can control the projector using a web interface or sensor to trigger the projector to life!

This is a simple, fun projector. It has very few electronics, but plenty of space for us to add to it. The unit is water-resistant, but not for use in downpours, as the seal will ultimately fail. The cartridges are easy to open, and grant us the ability to make our own images, meaning we can truly make this our own! For £20, the '4W' projector is a bargain, while for £30, the 6W version will produce a brighter and clearer image while retaining the 'hackability' of the unit we tore down. □

**Above** □  
The inner lens is directly connected to the motor and LED PCB. This lens focuses the light through the image cartridge, ready for projection

**Left** □  
The motor is directly connected to the outermost lens via a screw. But, the LED PCB is fixed to a number of thick lenses, used to intensify the light





# Raspberry Pi 3A+

A long-awaited upgrade for the mid-sized model

RASPBERRY PI ◆ \$25 | [raspberrypi.org](http://raspberrypi.org)

By Ben Everard

[@ben\\_everard](https://twitter.com/ben_everard)

**Below** ■  
The board features the same metal heat spreader over the SoC and the Pi-logo-embossed wireless module

**T**he Raspberry Pi is the maker world's most popular small computer. It brings the power of Linux – an operating system more commonly associated with high-powered servers – to computers small enough to fit in almost any contraption. They give makers access to a huge range of tools such as web servers, databases, and data-processing engines that can fit in a space the size of a credit card.

When the Raspberry Pi was first released, it came in two form factors: the A and B, with the A being cheaper, and with half the RAM. The B has gradually become more powerful as it's gone through various iterations (the most recent of which is the 3B+) which have brought more computing power and more RAM, while the A has had just a single upgrade (to the A+, bringing a smaller PCB and a larger GPIO header).

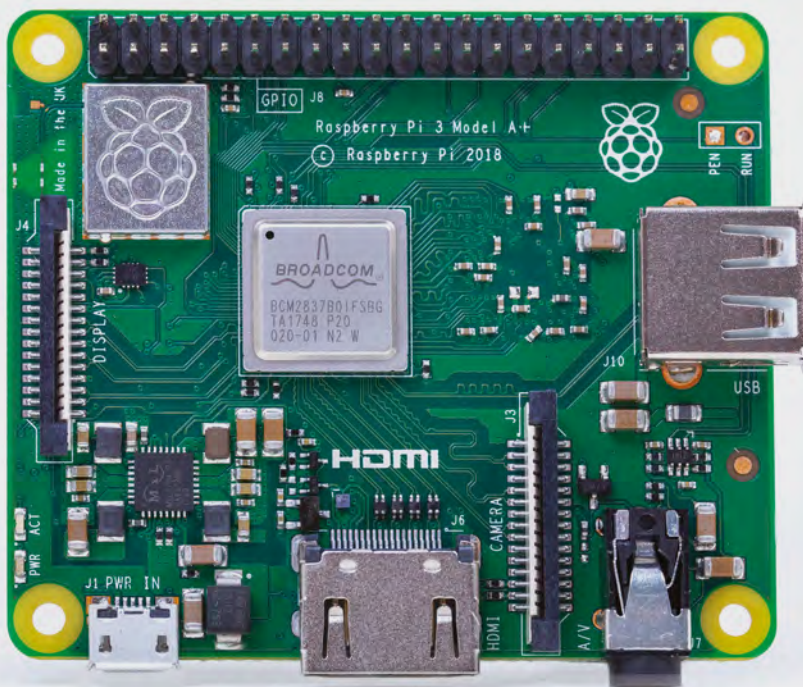
This new update brings the A+ form factor bang up to date by matching the computational power of the 3B+ with the same 64-bit quad-core ARM Cortex A54 (ARMv8) running at 1.4GHz. The only difference between the 3A+ and the 3B+ from a computational point of view is that the 3A+ has got 512MB of RAM compared to 1GB on the 3B+. Oh, and did we mention that the A+ is almost a third cheaper?

## WELL CONNECTED

The 3A+ is also well poised for connection to the outside world, as it has on-board wireless LAN and Bluetooth (however, no wired Ethernet). A single USB port gives you some scope for adding extra hardware as does that standard Raspberry Pi 40-pin GPIO header.

The power draw is significantly lower on the 3A+ compared to the 3B+. With idle load about half (approximately 1W compared to 2W), and draw under heavy computational load about 4W compared to 5.5W for the 3B+.

What all this means in practice is that the 3B+ is still the best option in the RPi line-up for a desktop machine: the extra RAM will help with multitasking on the desktop, and the extra USB ports help with luxuries such as having both a keyboard and



a mouse. However, the Pi is far more than a desktop machine. HackSpace magazine readers will no doubt have seen it embedded in all sorts of hardware.

It's in this embedded space that the A+ really shines. The lower power draw, particularly when idle, means it runs on batteries or other non-mains power (such as solar) far better than the 3B+. You could get twice the battery life just by running the same software on a different board.

The 3A+ is a drop-in replacement for the 3B+ provided you're not using the extra USB ports or Ethernet connection. You can just pop the microSD card in your new board and you'll be ready to go. Any hardware attached via the GPIO header will continue to work, and the mounting holes are in the same place.

### A BALANCING ACT

The 3A+ sits in the middle of the Raspberry Pi range. As well as the more-connected 3B+ above it, there's the smaller, even lower-power Zero (and Zero W) below it. These tiny boards are about half the size of the 3A+ and come with the same SoC that graced the original Raspberry Pi models (though sped up to 1GHz). These boards are great for projects that need to be extra small or low power (they draw about half the power of the 3A+

when idle); however, the downside is that they are significantly less computationally powerful. For many uses, this isn't a problem, but if you're going to be doing anything intensive – such as image processing – then you're going to struggle with the Zero.

The new 3A+ brings the computational power of more recent Raspberry Pi boards to a form factor more suitable for embedding. The lower power draw, smaller size, and lower cost are all a boon for makers. Whether you're making a robot, paying tribute to a film with some recreated animated props, building a dancing Santa for the coming holiday season, or anything else, this Pi just made your life a little bit easier. □



**Above** □ The camera and display connectors can be used with the official hardware to add a visual aspect to your makes

## RASPBERRY PI OFFERINGS

If you're looking for a Raspberry Pi for your next project, here's our handy guide to the current boards

MODEL	PRICE	CPU	RAM	NETWORKING	CONNECTIVITY
Pi Zero	\$5	1GHz single-core ARMv6	512MB	None	40-pin GPIO header, 1 × USB OTG
Pi Zero W	\$10	1GHz single-core ARMv6	512MB	Wireless LAN, Bluetooth	40-pin GPIO header, 1 × USB OTG
Pi 3 A+	\$25	1.4GHz quad-core ARMv8	512MB	Wireless LAN, Bluetooth	40-pin GPIO header, 1 × USB port
Pi 3 B+	\$35	1.4GHz quad-core ARMv8	1GB	Wireless LAN, Bluetooth, Ethernet	40-pin GPIO header, 4 × USB ports

### VERDICT

Plenty of computing power in an extra-small form factor.

**10**/10



# Miniware TS100 Soldering Iron Two-Tip Bundle

A hackable soldering iron in a convenient package

MINIWARE ♦ £69.98 | [miniware.com.cn](http://miniware.com.cn)

By Gareth Halfacree

 @ghalfacree

**T**raditionally, when shopping for a soldering iron, there's a clear choice to make – you can buy a fixed-temperature soldering iron, which is little larger than a bulky pen or screwdriver and which plugs directly into the mains, or you can buy a temperature-controlled soldering station which links the iron to a typically hefty control and power box, which sits on your desk. The latter takes up more room, but offers fine-grained control to make your soldering easier and less likely to end in a 'cold joint'.

The Miniware TS100 is a hybrid design which sits between these two. The iron itself is smaller than most fixed-temperature irons, but it hides all the functionality of a large control station inside its sleek housing. That reduction in size, though, does come at a definite cost. The first clue that you're holding something quite different to

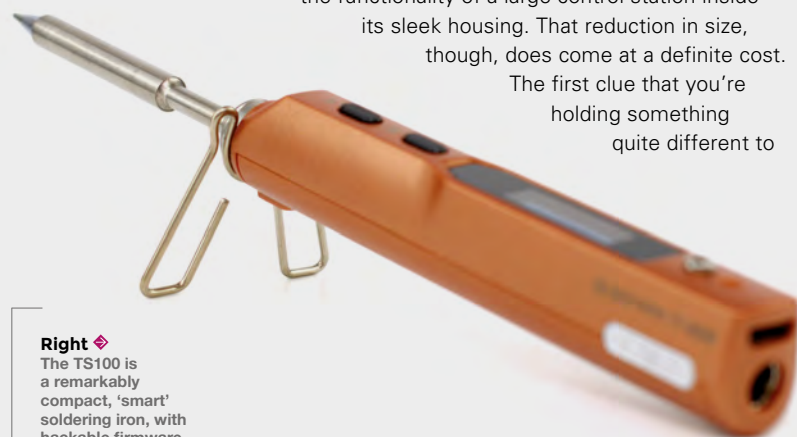
the norm is found on the iron body: a small OLED display panel and two buttons provide on-body temperature control, while a micro USB connector suggests that there may be more to the TS100 than meets the eye.

Installing the tip – provided with a cone-type and chisel-type in the reviewed bundle – is quick and easy, using the bundled Allen key, and powering the iron on is a simple matter of plugging the bundled power supply into the end of the iron and a mains socket.

## ONBOARD CONFIGURATION

As the TS100 boots up, a process you wouldn't normally associate with a soldering iron, it will set a target temperature and then begin to heat the iron tip to that temperature. A push of the buttons allows you to shift the target up or down to accommodate different solder types or more heat-sensitive components, and the heating of the iron is based on feedback from the tip – meaning that if you're soldering a larger joint which is pulling heat away quickly, the iron will provide more power than if you were soldering a smaller joint, the key difference between a simple variable-temperature and a true temperature-controlled iron.

It's at this point you might think you're ready to solder, but there's an unfortunate flaw in the TS100's design – in addition to a housing shape which makes it possible for the iron to slip backwards through a too-weak grip and burn the user's fingers: the iron tip shows a 'floating voltage' from the power supply, easily enough to damage sensitive components.



**Right** ♦  
The TS100 is a remarkably compact, 'smart' soldering iron, with hackable firmware



**Above** ■ An on-board OLED display and two buttons provide variable temperature control

The solution is provided in the bundle: a grounding strap, which screws to a dedicated ground terminal at the end of the iron, should then be connected to a suitable ground, such as a mains grounding terminal adapter. When connected, the iron is safe to use – but, without it, you’re likely to find your components silently failing for no apparent reason.

The power flaw is a real shame, as it impacts on the flexibility of the iron: accepting 12–24V inputs, it should be possible to power the iron with a single cable to

“ **The first clue that you’re holding something quite different to the norm is found on the iron body** ”

a suitable battery; without the extra grounding strap, though, it’s just not safe.

An investigation of the micro USB connector reveals why you might want to put up with the flaws and foibles of the iron anyway: inserting it into any PC loads a selection of configuration files which can be edited and saved to change a variety of settings, including how long it takes for the iron to enter its clever power-saving sleep mode.

For the more adventurous user, you can go still further: Miniware has released the iron’s firmware source code, allowing for a variety of hacks and modifications. Some have already used the code to write new firmware with an improved user interface and better features; others have used it to change the

iron into a completely different tool, from a Tetris-like handheld console to a fully functional, though basic, oscilloscope.

The TS100 isn’t a new iron, it’s been around for over a year, so there’s been plenty of time for the community to put it through its paces. Those interested in picking up a TS100 of their own should know that Miniware has already designed and released its successor, the TS80. Featuring a range of improvements – but, sadly, the same smooth housing with no flaring to the front, still risking burnt fingers if you let it slip backwards – the more expensive TS80 is, an upgrade to the TS100, but at the time of writing was available only for import from Chinese distributors, with no bundled power supply.

While the TS100 is never going to replace a high-end soldering station – especially one with hot-air functionality, allowing for easy soldering of more complex surface-mount parts and quick desoldering of components for reuse elsewhere – it’s an interesting tool, and one which can be combined with a suitable battery for on-the-go repairs.

Its open-source firmware is also a fascinating concept, and one which flies in the face of many tool companies, which appear to go to great lengths to lock down their designs against third-party modification – typically as a way of selling identical hardware in entry-level and professional-grade guises, differentiated only by the features enabled in their firmware.

Anyone who does pick up a TS100 is recommended to install the rewritten Ralim TS100 firmware, available at: [github.com/Ralim/ts100](https://github.com/Ralim/ts100), which is a great improvement over the stock firmware provided by Miniware. □

## VERDICT

The TS100’s flaws don’t quite outweigh a clever design and hackable firmware.

7 / 10



# The Weekend Woodworker

A workshop in a box

THE WEEKEND WOODWORKER ♦ \$147 | [theweekendwoodworker.com](http://theweekendwoodworker.com)

By Daniel Hollands

[maker.limeblast.co.uk](http://maker.limeblast.co.uk)

**F**or anyone starting to learn woodworking, you can't go far wrong with Steve Ramsey's Woodworking Basics playlist, a collection of 17 (and counting) free videos, providing useful information on some of the tools

and techniques you're going to need. These are an excellent resource for learning specific things in isolation, but if you're anything like us, you learn better by getting your hands dirty with a project, which is where Steve's premium course, The Weekend Woodworker, comes into its own.

The course, delivered weekly via the website, consists of six projects, each designed to be built in a weekend. Each project consists of two videos (one for the Saturday, one for the Sunday), plans in PDF format for both metric and imperial measurements, along with SketchUp files for each, and a full list of tools, equipment, and materials required.

The videos follow Steve as he builds each project, showing in great detail exactly what you need to do to follow along. Each new project builds upon what you learn in the previous one, slowly but deliberately introducing new techniques, showing how to get the most out of the tools, and letting you gain skills and knowledge gradually.

**Below**

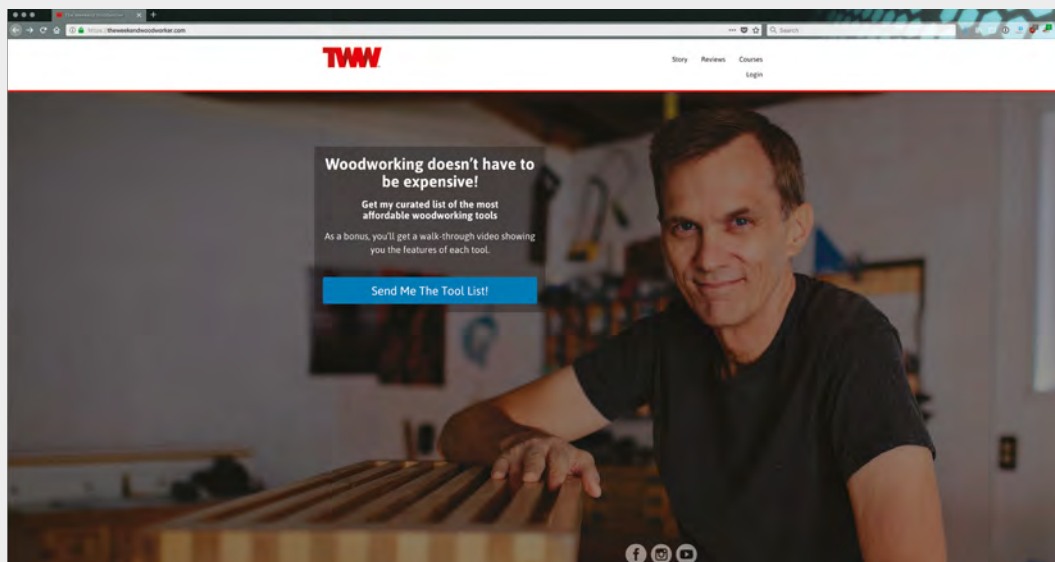
One of this reviewer's builds – as someone new to woodworking, this stands as a testament to this course



## FROM THE TOP

The first two projects, a patio table and a garden bench, introduce the mitre saw, drill, impact driver, and random orbit sander. The third project, an office paper tray, introduces the table saw and jigsaw, and by the fourth, a coffee table, you'll find yourself using a circular saw. The final two, a bookshelf and wall cabinet, then hone your previously learned skills, and enhance them further. Each project concludes with applying a suitable finish.

The only outlier to this gradual build-up is the bonus project, the Basic Mobile Workbench. This is



**Left** ◆ On the website, Steve shows off the Harmony Garden Bench that you'll be crafting

because the only tool from the above list that isn't required for its construction is the table saw. But, even being thrown in the deep end like this isn't all that daunting, as Steve is a fantastic teacher – and it helps that, being a workshop tool, aesthetics are less of a concern, meaning less pressure. This is the first project your reviewer built – his first ever woodworking project – and we recommend you do the same, as it's a good introduction and becomes a key tool in the building of the projects going forward.

Talking of mistakes, Steve makes a few of them during the videos (it's evident he plans each project beforehand off-camera, then records as he builds them for the first time). But, this is honestly one of our favourite parts of any of his videos, because he always addresses the mistakes and uses them as an opportunity to teach. This is all part of his presentation style, which is heavily influenced by his personality, his sense of humour, and his ten years of making videos for YouTube – which clearly shows in his amazing production value. Even if you weren't all that interested in woodworking, you'd find any of his videos entertaining in their own right.

His approach to woodworking is pragmatic, and designed to solve a problem. He doesn't teach you dovetail joints, for example, when there are easier ways of joining two pieces of wood. But that's not to say his projects are ugly. In fact, the very second project, the garden bench, was designed to be a thing of beauty to encourage you to think of aesthetics and overall design from the outset of a project, rather than something you'll hopefully stumble onto later.

In addition to the main projects, there are a number of auxiliary resources also supplied via the website. These consist of safety tips and videos on how to avoid accidents, information on how to obtain the tools required for the course (more on this in a

moment), advice on buying lumber and setting up a workspace (even if you don't have a lot of room to work in), advice on selling your projects, and a selection of plans for other projects. You'll also be invited to a private Facebook group to talk with other members.

### BUILDING A WORKSHOP

One thing to be aware of is the costs – not to buy the course itself, which we think is great value, but the cost of the equipment and materials required to complete it. Woodworking isn't the cheapest hobby,

“ **His approach to woodworking is pragmatic, and designed to solve a problem. He doesn't teach you dovetail joints, for example, when there are easier ways of joining two pieces of wood** ”

and Steve tries to keep the costs down as much as possible by supplying a shopping list of cheap (mostly Ryobi) tools – the same tools he actually uses in the videos. While we're sure the 'Under \$1000' tool shopping list is good value, especially when offset against the many, many projects they can help you make, it's still a lot to spend in one go, and this doesn't include the cost of the other equipment, materials, and lumber.

This isn't just a course to teach you how to build the six projects contained within: it uses these as a vehicle to teach woodworking – and at the end of it you'll walk away with a fully stocked workshop, six weekends' worth of guided experience, and knowledge needed to confidently start building your own projects. □

### VERDICT

Provides everything that someone starting their journey into the world of woodworking needs.

9/10



# Graff SpeedCutter

Reduce trees to sawdust in minutes

**GRAFF** ♦ \$18.60 | [speedcuttergraff.com](http://speedcuttergraff.com)

By Ben Everard

[@ben\\_everard](#)

**T**he Graff SpeedCutter is a blade for angle grinders that converts them into wood-cutting and carving beasts. It's a disc with three tungsten carbide teeth available for 115mm (4½ inch) or 125mm (5 inch) grinders.

It must be said, it's a terrifying tool. Angle grinders kick out an awesome amount of power, and don't have the sort of safety features usually found on wood saws. The Graff website claims this blade is safer than attaching a circular saw blade to a grinder, though that's hardly surprising, as the alternative is ridiculously dangerous. One key difference between

this and a circular saw blade is that Graff's is designed to reduce kick-back.

On table saws (which use a circular spinning blade similar to this), kick-back is where the object being cut is rapidly thrown at the operator. In chain-saws (used for carving in a similar way), it's where the blade jams and rapidly accelerates towards the operator's head (hopefully with the chain brake activating). In reality, these are both the same event – the blade jams in some way and as it can't cut; it instead converts its energy into motion, either of the saw or the object being sawn. As you're probably going to be using this on an object that's securely clamped down, the risk is that the saw is rapidly accelerated in the direction opposite the spin of the wheel. We didn't experience any kick-back, but it's prudent to hold the grinder so that you can brace against this type of kick-back, and position yourself so it won't meet your head if it does happen.

Before you even consider switching this on, you'll need work gloves, safety goggles, and a face mask. This blade kicks out a lot of high-velocity sawdust in almost every direction (it seems to curl around the grinder guard to come right into your face at any angle, and blasts into your knuckles). You will need your angle grinder guard, and we can't recommend using it without the handle attached on your grinder.

The SpeedCutter can be used as a saw. It absolutely rips through wood up to about 4 cm thick, (depending on the clearance of your angle grinder). However, it lacks an application where it would be a good saw. It can't cut curves, yet the form factor of the grinder also means it's hard to cut really straight lines. There are better, more suitable, and safe saws available for any application we can think of.

## ARTISTIC DESTRUCTION

Arguably, the SpeedCutter's most useful woodworking feature is its ability to carve out wood. You can glide the blade over the surface to skim off bits of wood in

**Below** ■ There are just three blades on the wheel, so only one is engaged with the wood at any one time





any direction. It's unlike any other tool we've used. It's almost half-way between a regular angle grinder cutting disk and a grinding disk, except this is for wood (and can also cut plastic and aerated concrete) and capable of removing far more material. Each pass can easily carve out several millimetres of wood – go any deeper and the blade starts to pull in the direction of rotation. Holding the tool securely in both hands, this pull isn't strong enough to feel dangerous, but it is enough to pull the blade slightly out of line, and can cause your carving to go awry.

It's more like chain-saw carving than anything else, so it's not surprising that it's popular as a power carver, though it could be used to cut out larger wooden joints if you've got a steady hand.

The most disconcerting thing about using the SpeedCutter is that it cuts so cleanly that it's almost

**// Before you even consider switching this on, you're going to need work gloves, safety goggles, and a mask //**

impossible to feel whether it's engaged with the wood or not. With most carving tools, you can feel the wood under your tool, but this just glides through it and suddenly there's air where the wood used to be. It feels a bit surreal to carve like this, especially with something as tough as wood. It's almost like trying to carve air. We found it took a little while to get used to – as we had a tendency to keep pushing until we felt the blade engage, but by this point, there was already quite a lot of wood missing. This tool is hugely powerful, so it's a bit surprising that it needs a delicate touch to get good results. Compared to chain-saw carving, it feels dainty and precise.

We found that the SpeedCutter left a cleaner cut in some directions than others, due to the way the blade sliced through the grains (in some directions, the surface of the wood remains smooth; in others, it splintered slightly). This sort of finish is to be expected with a tool of this cutting power, and adds to the power-carving aesthetic.

The tool's big limitation is its form factor. Angle grinders aren't really designed for this sort of work, and the basic shape of the body can cause problems. If you're trying to carve out deep, narrow parts, the grinder can get in the way and, because you're using a disc 115mm across, you're limited to the shapes of the depressions you can carve. Of course, every tool has its limits, but if you plan your designs well, your ambitions shouldn't be held back too much.

This isn't a particularly safe tool and needs to be treated with respect; we'd only recommend it to experienced power-tool users. However, there aren't any safe tools for power carving. The very nature of the hobby means you'll be moving around something capable of easily slicing wood. The alternative is a chain-saw and we wouldn't recommend a web search for chain-saw injuries while you're eating. If you're used to handling powerful tools, the Graff SpeedCutter is a fun way of turning some scrap wood into artwork. □

**Left** ♦ Because of the size of the blade, you're quite limited with the angle of the indentations you can achieve

**Below** ♦ Simple designs, such as mushrooms, can be created in a matter of minutes

## VERDICT

A powerful and fun carving tool, but needs to be treated with respect.

**8**/10





# MonkMakesDuino LCD kit

An Arduino in a new form factor

MONK MAKES ♦ £25 | monkmakes.com

By Ben Everard

@ben\_everard

**T**he MonkMakesDuino LCD kit is a beginner's kit to help people get started with microcontrollers and electronics. Perhaps the most unusual piece in this kit is the microcontroller, the MonkMakesDuino.

The form factor of the MonkMakesDuino is unique – we're not aware of any other microcontroller board that slots into a single side of a breadboard. There are some that can span the spine, and some that can use adaptors to fit in, but no others that slot in quite so neatly. There are good and bad parts to this. The good side is that it gives you much more space on a standard breadboard – even a half-sized one – for prototyping your circuits. The downside is that it's a pretty useless form factor for anything

**// We're not aware of any other microcontroller board that slots into a single side of a breadboard //**

other than breadboard prototyping. Shields won't fit without fiddling around with wires to poke into the headers on the shield. The result of this is that the MonkMakesDuino is a great platform for learning about microcontroller electronics, but not necessarily the best platform for more complex projects – especially if you want to use additional hardware.

That's not a huge problem, as this is essentially an Arduino Uno bent into a different shape. When you want to work with shields, you can switch to the more traditional platform with minimal difficulty.

In this kit, you get the parts and instructions to make seven projects, taking you from a simple blinking LED,

to an LCD display thermometer. They're all easy to build, and the instructions are well-written and suitable for beginners. You should find that you can complete the projects quite quickly, and this will teach you the basics of using an Arduino.

From this, you may well find that you would prefer to progress to using a different format board so that you can use shields or some other form of add-on, but it'll still be useful to have a MonkMakesDuino in your toolbox, for times when you need to head to the breadboard. The other bits that come in the kit are all general-purpose so, even when you've finished with the projects, you'll no doubt still find uses for most of the hardware.

For the price, this is a great beginner's kit for getting started with microcontroller electronics, especially as it includes a well-written and comprehensive set of instructions. □

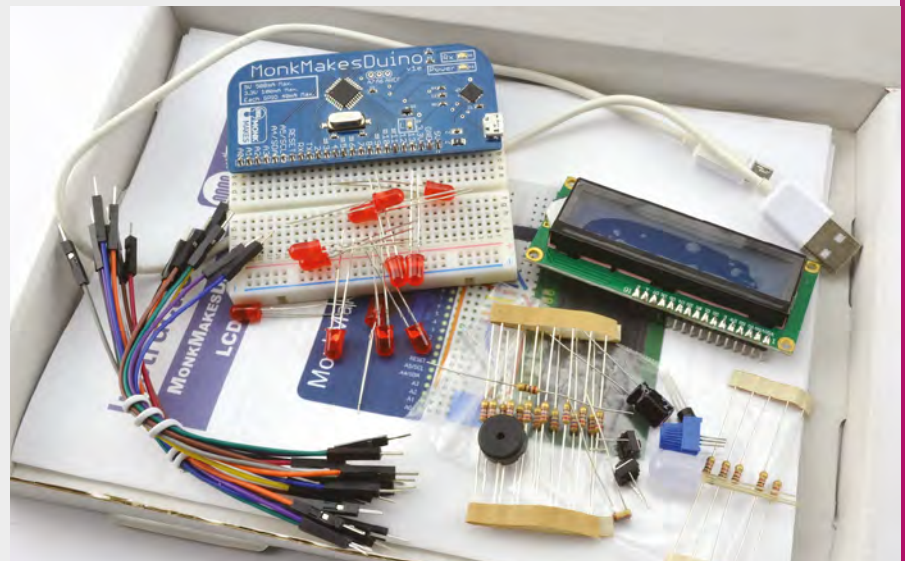
## VERDICT

Everything you need for your first foray into the world of microcontrollers.

8/10

### Below

The single row of pins slots neatly into a breadboard, leaving the entire other side free



# Harry Potter and the Methods of Rationality

Eliezer Yudkowsky ♦ FREE download | [hpmor.com](http://hpmor.com)

By Richard Smedley

[@RichardSmedley](https://twitter.com/RichardSmedley)

**W**hat could be more maker than making your own stories, repurposing favourite characters and worlds? From countless Sherlock Holmes ‘adaptations’ and follow-ons, to the sharing of Michael Moorcock’s cut-up novels’ character, Jerry Cornelius, amongst 1960s counter-culture novelists – fan-fiction was around long before the days of pre-web internet bulletin boards publishing fans’ stories of *Star Trek* characters.

The long gaps between publication of the first four *Harry Potter* novels, combined with social sites like LiveJournal and **FanFiction.net**, saw a multitude of fictions and cross-overs, in particular highlighting lesser

characters given little positive limelight by Rowling, and Queering the Canon ([hsmag.cc/oECcrY](http://hsmag.cc/oECcrY)) to get a much-loved fiction to properly represent minorities.

Some writers from those days – Cassandra Clare, Sarah Rees Brennan – have gone on to fame with original works, whilst others, like Manchester’s AJ Hall, have left intriguing works of the quality of published fiction. But we turn here to a more recent fic. One which, whilst very entertaining in its own right, is of particular interest for its STEM educational value – and its avowed aim of making us less wrong. Eliezer Yudkowsky “writes about the fine art of human rationality” at [lesswrong.com](http://lesswrong.com) – dedicated to overcoming cognitive biases, in order to make us saner and happier in a world full of difficult problems to be solved.

But, along the way, this work is as much a page-turner as the first three Rowling novels, with the added benefit of humour, a strong campaign against school bullies, a constant collision between physics and magic, and a story arc based on credible actions by intelligent characters.

Yes, if you’re a British English speaker, the Americanisms will occasionally grate, or even coagulate the delicate suspension of disbelief [enough of the mixed metaphors – Ed], but stick with it. And, if you feel you’re just not the sort of person to whom fan-fiction will appeal, you may well be right – but give it a few chapters to test that theory out (don’t believe everything you think, as the book puts it)!

If you’d rather go straight to overcoming cognitive biases, without engaging with the Potterverse, just head over to [lesswrong.com](http://lesswrong.com) – and if you mistrust free content, go and buy *Thinking, Fast and Slow*, for the same information! □



## VERDICT

A serious look at thinking more clearly, wrapped up in an entertaining page-turner.

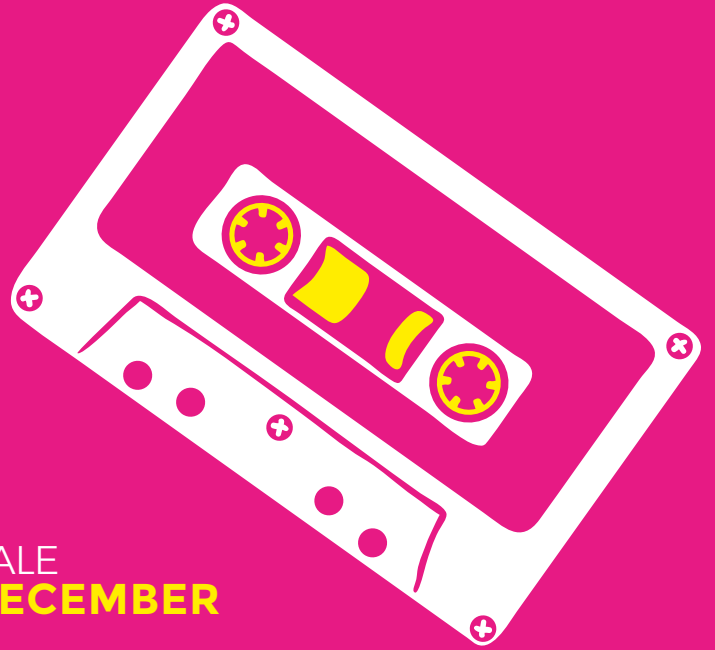
8/10



# next month

issue  
#14

ON SALE  
20 DECEMBER



## FEATURING DIY MUSIC

---

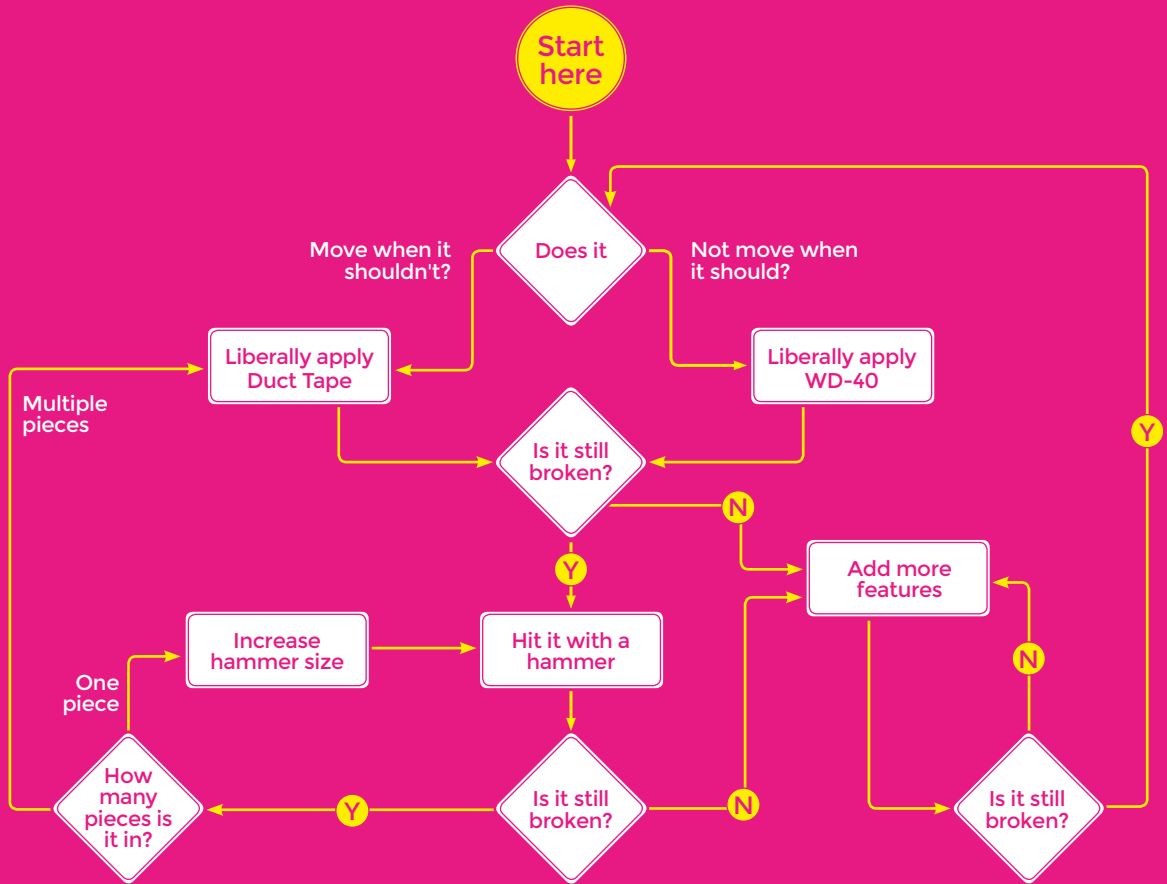
### ALSO

- ELECTRONICS
- LASER CUTTING
- METALWORK
- ROBOTICS
- ALL THE BEST PROJECTS FROM THE MAKERSPHERE

---

**DON'T MISS OUT**

[hsmag.cc/subscribe](http://hsmag.cc/subscribe)



# HOW TO FIX ANYTHING



# Canakit Raspberry Pi 3 Complete Starter Kit



## Kit Includes:

- ✓ **Raspberry Pi 3 Model B**  
Quad-Core 1.2 GHz 1 GB RAM
- ✓ **On-board WiFi and Bluetooth**
- ✓ **32 GB MicroSD Card (Class 10)**
- ✓ **Canakit 2.5A Power Supply**
- ✓ **High Quality Case**
- ✓ **HDMI Cable with CEC support**
- ✓ **MicroUSB Reader**
- ✓ **Set of Heat Sinks**
- ✓ **GPIO Quick-Reference Card**
- ✓ **Canakit Quick-Start Guide**

Available for worldwide shipping at:

**WWW.CANAKIT.COM**



**\$74.<sup>99</sup>** **£59.<sup>99</sup>** **€64.<sup>99</sup>**  
USD DOLLARS      EXCLUDING VAT      EXCLUDING VAT

Raspberry Pi is a registered trademark of the Raspberry Pi Foundation.  
 Canakit is a registered trademark of Cana Kit Corporation.