

MAKE | BUILD | HACK | CREATE

HackSpace

TECHNOLOGY IN YOUR HANDS

hsmag.cc

January 2021

Issue #38

MICROMOD

Microcontrollers go modular

PLUG AND PLAY

Wire your projects without soldering

Billie Ruben

Bringing craft and digital design together



RASPBERRY PI XMAS

The best festive makes



How DIYers recreate film props, costumes, and memorabilia



Jan. 2021 Issue #38 £6



LASER ETCHING

Make stunning multicolour images

DOOR BELLS KEYS FACE RECOGNITION MUSIC

Board?

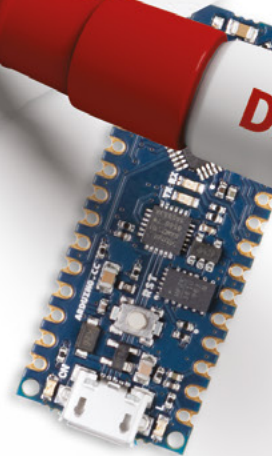
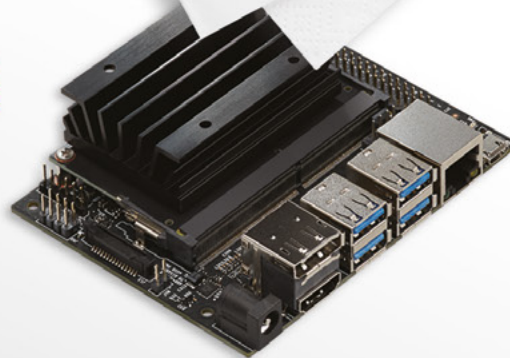
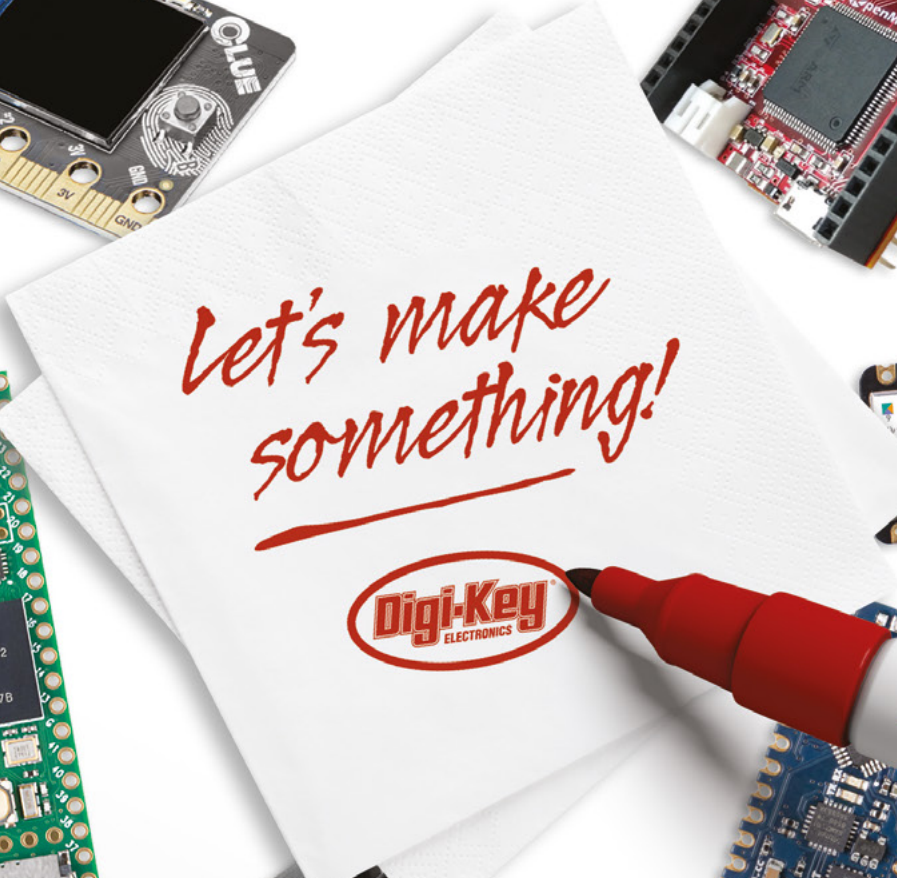
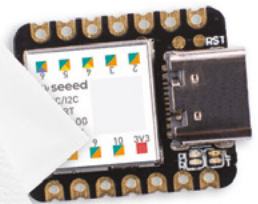
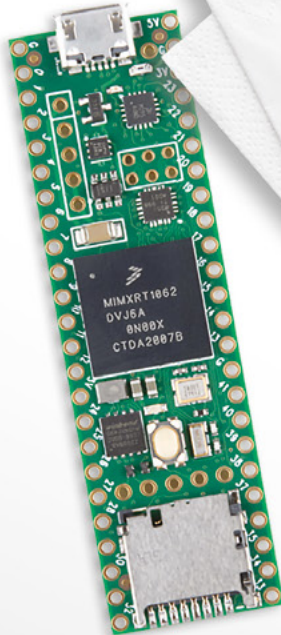
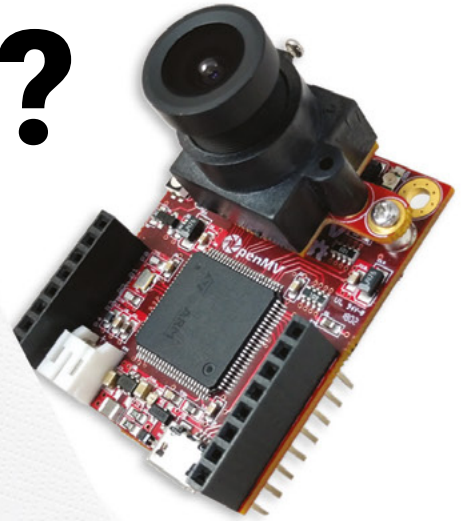
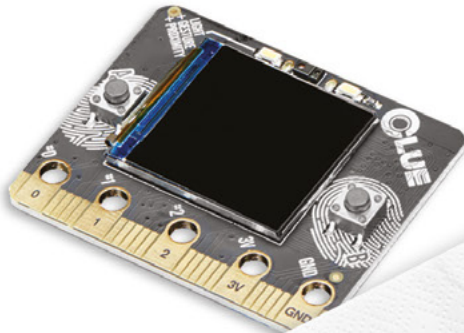

0800 587 0991
DIGIKEY.CO.UK



9.6 MILLION+ PRODUCTS ONLINE | 1,200+ INDUSTRY-LEADING SUPPLIERS | 100% FRANCHISED DISTRIBUTOR

*A shipping charge of £12.00 will be billed on all orders of less than £33.00. A shipping charge of \$18.00 USD will be billed on all orders of less than \$50.00 USD. All orders are shipped via UPS, Federal Express, or DHL for delivery within 1-3 days (dependent on final destination). No handling fees. All prices are in British pound sterling or United States dollar. Digi-Key is a franchised distributor for all supplier partners. New products added daily. Digi-Key and Digi-Key Electronics are registered trademarks of Digi-Key Electronics in the U.S. and other countries. © 2020 Digi-Key Electronics, 701 Brooks Ave. South, Thief River Falls, MN 56701, USA





Welcome to HackSpace magazine

Movies are a great form of escapism. A way of forgetting our cares and worries for an hour or two before returning, slightly refreshed, back to reality. Sometimes it's nice to hold on to that escapism for a little longer than the running time of the movie, and bring a little of the magic from the silver screen into the real world.

This month, we're looking at the makers who've done exactly that. Whether it's a piece of clothing, a prop, or some other paraphernalia, these makers are getting to live the life of

Whether it's a piece of clothing, a prop, or some other paraphernalia, **these makers are getting to live the life of their on-screen heroes**, if only for a little while

their on-screen heroes, if only for a little while. Speaking of bringing magic

to life, Helen Leigh's walk-on keyboard (see page 94) is a little bit of wonder you can make at home. It's fun to play by yourself, and the perfect way of entertaining children and relatives over the holidays.

BEN EVERARD

Editor ben.everard@raspberrypi.org

Got a comment, question, or thought about HackSpace magazine?

get in touch at hsmag.cc/hello

GET IN TOUCH

hackspace@raspberrypi.org

[hackspacemag](#)

[hackspacemag](#)

ONLINE

hsmag.cc



EDITORIAL

Editor

Ben Everard

ben.everard@raspberrypi.org

Features Editor

Andrew Gregory

andrew.gregory@raspberrypi.org

Sub-Editors

David Higgs, Nicola King

DESIGN

Critical Media

criticalmedia.co.uk

Head of Design

Lee Allen

Designers

Sam Ribbits, James Legg,

Ty Logan

Photography

Brian O'Halloran

CONTRIBUTORS

Lucy Rogers, Drew Fustini, Jo Hinchliffe, Mayank Sharma, Andrew Lewis, Marc de Vinck, PJ Evans, Helen Leigh

PUBLISHING

Publishing Director

Russell Barnes

russell@raspberrypi.org

Advertising

Charlie Milligan

charlotte.milligan@raspberrypi.org

DISTRIBUTION

Seymour Distribution Ltd

2 East Poultry Ave,

London EC1A 9PT

+44 (0)207 429 4000

SUBSCRIPTIONS

Unit 6, The Enterprise Centre, Kelvin Lane, Manor Royal, Crawley, West Sussex, RH10 9PE

To subscribe

01293 312189

hsmag.cc/subscribe

Subscription queries

hackspace@subscriptionhelpline.co.uk



This magazine is printed on paper sourced from sustainable forests. The printer operates an environmental management system which has been assessed as conforming to ISO 14001.

HackSpace magazine is published by Raspberry Pi (Trading) Ltd., Maurice Wilkes Building, St. John's Innovation Park, Cowley Road, Cambridge, CB4 0DS. The publisher, editor, and contributors accept no responsibility in respect of any omissions or errors relating to goods, products or services referred to or advertised. Except where otherwise noted, content in this magazine is licensed under a Creative Commons Attribution-NonCommercial-ShareAlike 3.0 Unported (CC BY-NC-SA 3.0). ISSN: 2515-5148.

Contents

06

SPARK

- 06 Top Projects**
Awesome builds by awesome people
- 18 Objet 3d'art**
To create, one must first destroy
- 20 Meet the Maker: Billie Ruben**
How one maker blends textiles with hot plastic
- 26 Columns**
The best engineers aren't just engineers
- 28 Letters**
Finally – a use for the global cardboard mountain
- 30 Kickstarting**
Pixelblaze – WiFi-controllable lights
- 32 Hackspace Hackoustic**
Inside a den of sonic creators

110

LENS

- 38 Remaking movies**
Builds inspired by the big screen
- 50 Interview: Pete Wood**
Master boatbuilder and community curator
- 60 Improviser's Toolbox: Keys**
Speak, friend, and make things
- 64 Festive builds**
'Tis the season to be jolly creative

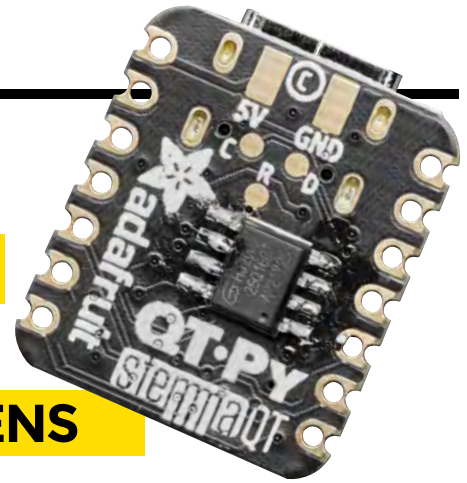

Tutorial

Lasers



78

Drive neighbourhood cats crazy with an automated light show

Cover Feature



38

102





94

Direct from Shenzhen

Compact compressed air



108

All we need is the air that we breathe, in a smaller space

71

FORGE

72 **SoM Solder-free connections**

Explore the standards joining I2C

76 **SoM Raspberry Pi**

Facial recognition with a HQ Camera

78 **Tutorial Lasers**

Flashy colours in the 40-watt range

84 **Tutorial IoT doorbell**

Make your doorbell smart – no Amazon required!

88 **Tutorial 3D printing**

Print with free design software FreeCAD

94 **Tutorial music**

Turn anything into a musical instrument



06

Meet the maker

Billie Ruben



20

Bringing a 19th century English aesthetic to PLA



84

32

101

FIELD TEST

102 **Best of Breed**

Mini synths for weird beeps and bleeps

108 **Direct from Shenzhen Portable air compressor**

For when you absolutely need bottom noise in a small space

110 **Review Adafruit QT Py**

An incredibly well-connected way to spend \$6

112 **Review SparkFun MicroMod**

Build microcontrollers like Lego



Some of the tools and techniques shown in HackSpace Magazine are dangerous unless used with skill, experience and appropriate personal protection equipment. While we attempt to guide the reader, ultimately you are responsible for your own safety and understanding the limits of yourself and your equipment. HackSpace Magazine is intended for an adult audience and some projects may be dangerous for children. Raspberry Pi (Trading) Ltd does not accept responsibility for any injuries, damage to equipment, or costs incurred from projects, tutorials or suggestions in HackSpace Magazine. Laws and regulations covering many of the topics in HackSpace Magazine are different between countries, and are always subject to change. You are responsible for understanding the requirements in your jurisdiction and ensuring that you comply with them. Some manufacturers place limits on the use of their hardware which some projects or suggestions in HackSpace Magazine may go beyond. It is your responsibility to understand the manufacturer's limits.

3D-printed LED vase

By maketvee

hsmag.cc/LEDVase

This 3D-printed vase is an absolutely brilliant piece of creativity. It's designed in Fusion 360, and used minimal electronics – just an Adafruit Trinket M0 and a 16-LED Adafruit NeoPixel ring.

The clever thing is that in the base of the vase, where the NeoPixel ring nestles, are the ends of 16 lengths of 2.85 mm transparent PETG filament. These guide the lights (which are, of course, programmable) in a spiral shape around the surface of the vase. □



Right □
We remember when fibre optics were going to be the next big thing



Arduino Heart

By Casey Hunt

hsmag.cc/eHeart

It's either scary or wonderful to think that we're only held on this mortal coil by a four-chambered bag of meat that twitches occasionally to send blood around our bodies. Either way, one side effect of our own mechanical simplicity is that it's relatively easy to make replica bits of ourselves.

This realistic heart, by Casey Hunt, is cast in Dragon Skin silicon from a mould bought on the internet, and fitted with a metal gear micro servo and a 5V battery pack to provide the beating motion. □

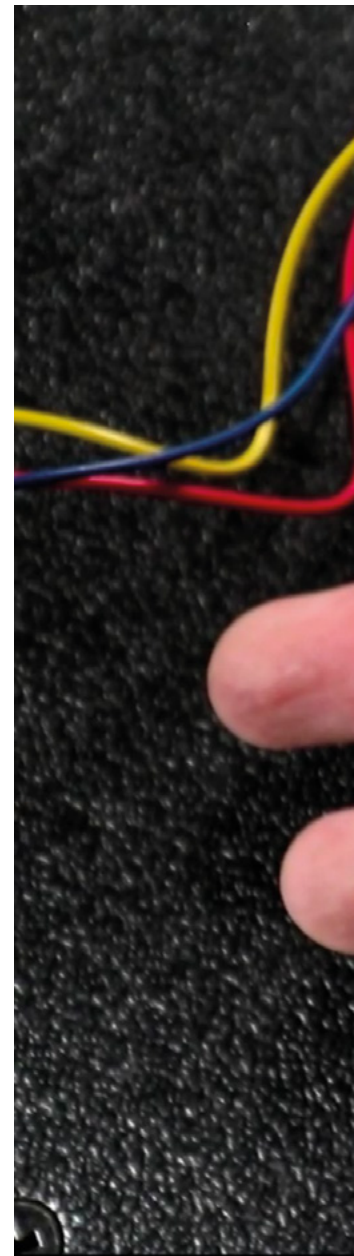
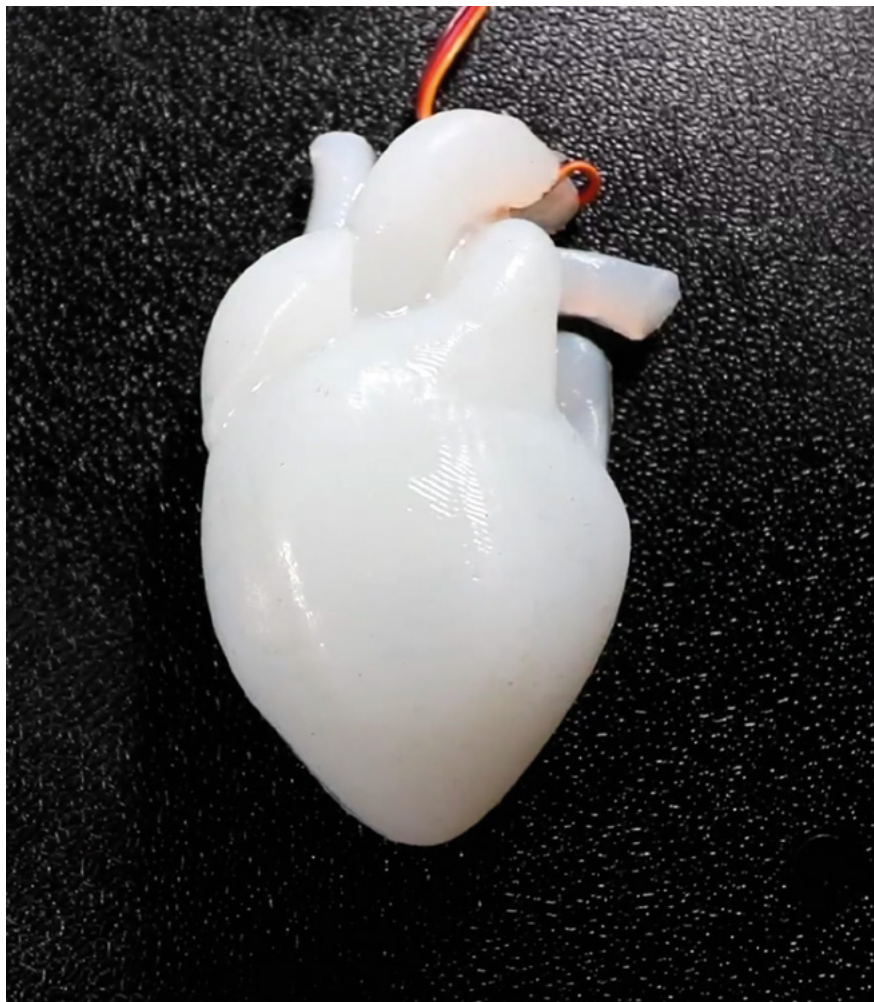

Right □
Wear your heart
on your sleeve



Breadboard wrist-watch

By Inge P

hsmag.cc/BreadTime

There's often something nice about projects that aren't quite finished. A few wires sticking out here and there show that the creator was too excited getting things working to go back and do boring stuff like make everything aesthetic. That's not what's going on here, though: Inge has chosen the half-finished look of breadboard electronics on purpose, to highlight the sheer geekery of making your own watch. □

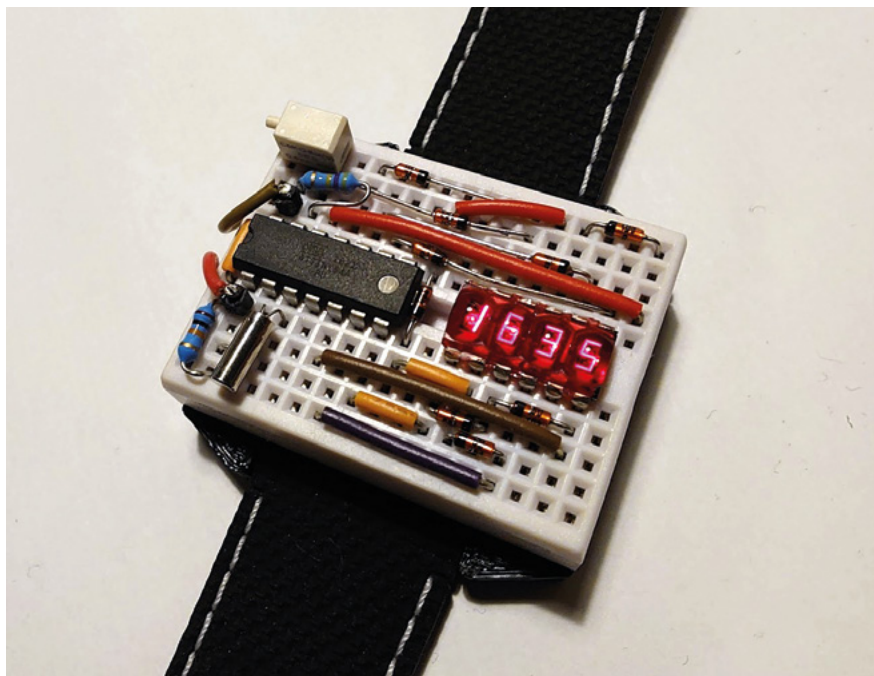

Right □
Inge's used a QDSP-6064 bubble LED display, powered by an ATtiny84A

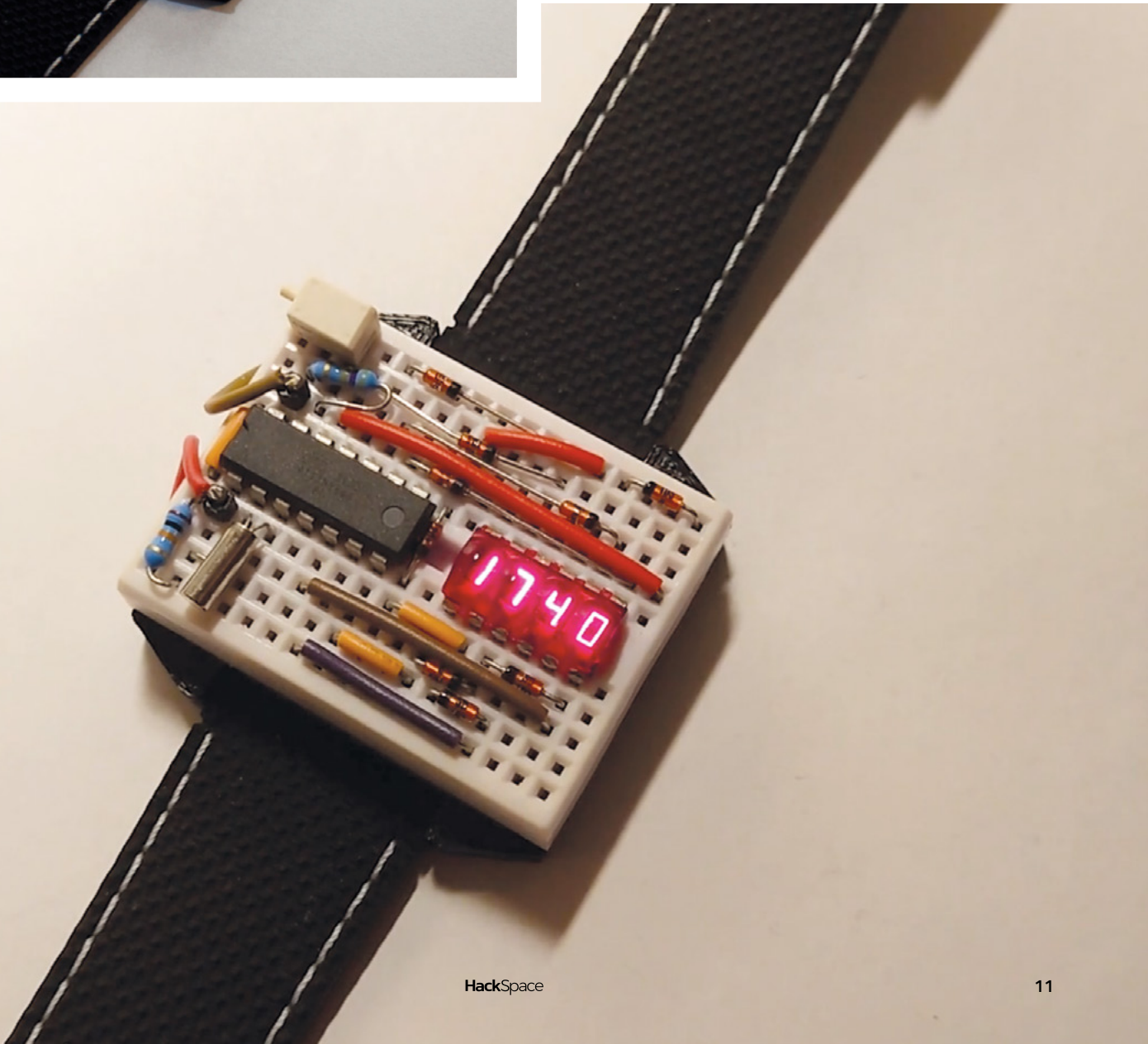
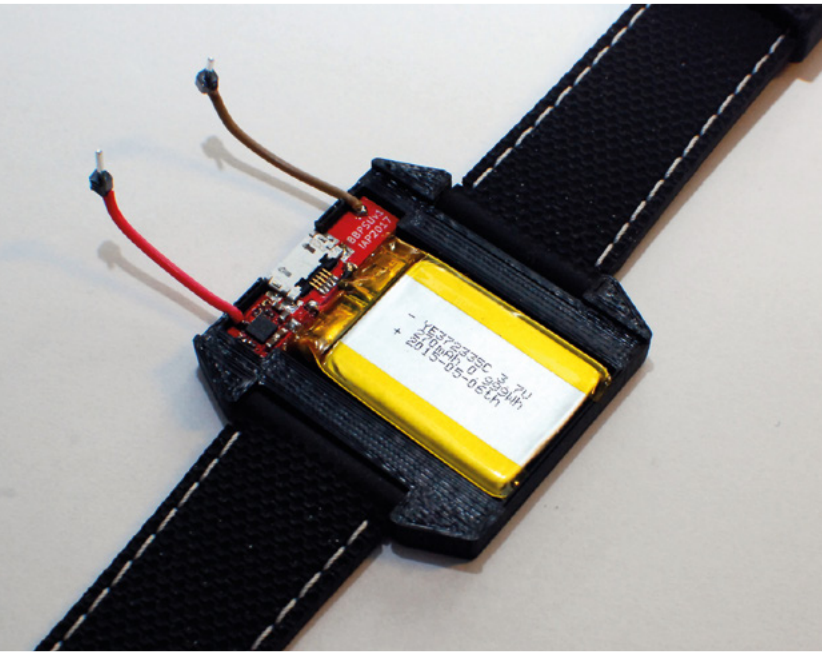

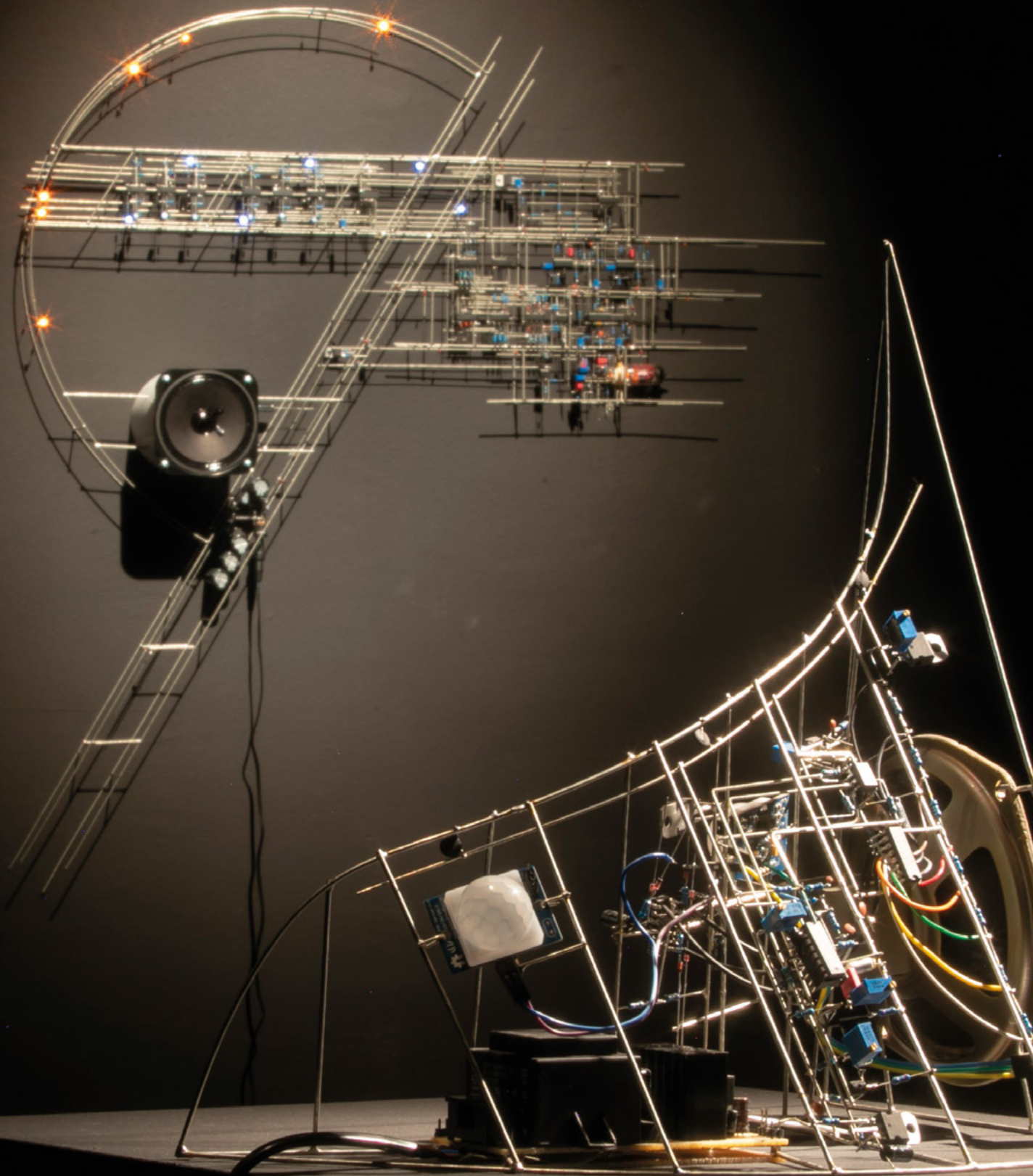

Waldian

By Eirik Brandal

hsmag.cc/Waldian

W

aldian, by Norwegian artist Eirik Brandal, is the winner of the Hackaday.io free-form Circuit Sculpture Challenge, narrowly prevailing over our brilliant (and unfairly overlooked) seven-segment display that we entered.

This is a standalone wall-hanging installation, capable of playing random permutations of notes programmed on a given melodic scale – think of the start of The Who's *Baba O'Riley* and its randomly generated riffs in the key of F major.

Electronics-wise, it comprises two oscillators to generate frequencies, an envelope generator, and a voltage amplifier – all controlled by logic gates. Finally, there's a valve overdrive stage in the circuit to make things loud and provide all the lovely organic harmonics that you get from vintage guitar amps. □

Left ♦
To accompany the music, Waldian also features twelve LEDs

Skully

By nerfhammer

hsmag.cc/Skully

We're suckers for pretty PCBs here at HackSpace Towers (as you'll know if you've seen any of Andrew Lewis's PCB engraving tutorials). So, it was with great joy that we discovered this badge by Tindie user nerfhammer. Unlike most cool badge designs, it's back-lit (the LED faces toward the wearer), giving it a weird glowy, floaty effect that's perfect for a copper skull.

The really clever thing is that this badge has an accelerometer built-in, so the light only comes on when it's moving, and the light is always oriented down, so it looks as if the skull is rising out of a pit of fire. That's the sort of detail that we appreciate. ▣



Right ▣
Skully is, according to its creator, “the greatest possible badge”



Four-stroke engine

By Maker B

hsmag.cc/FourStroke

W

e've featured the glorious work of Maker B before in these pages, in the shape of a solenoid four-cylinder engine that he machined himself from scratch.

This four-stroke engine is just as beautifully made, but even more impressive when you consider the tolerances achieved to make a working combustion engine at this scale.

The build began five months ago, and Maker B has chronicled every step of the way in a series of videos. If you're ever in need of solace in these troubled times, we wholeheartedly recommend watching the process. ▣

Right ◆
Very small horses
power this engine



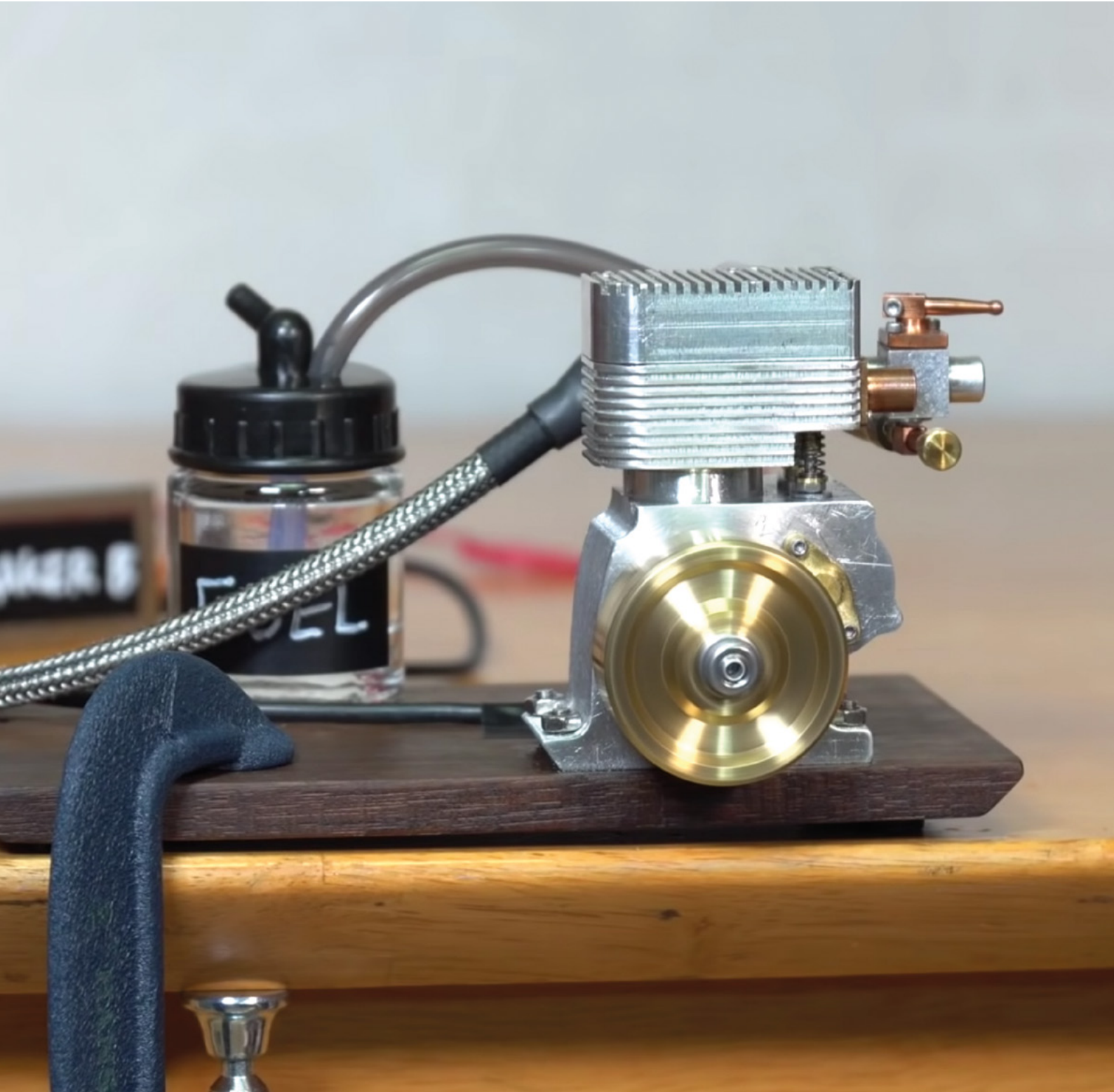

Objet 3d'art

3D-printed artwork to bring more beauty into your life

In common with geeks everywhere, we like recursion. With that in mind, here's a 3D-printed, 3D print shredder. It's an almost entirely 3D-printed shredder that can be used to shred 3D prints, and it's built on Brian Brocken's previous 3D-printed creation: a 162:1 3D-printed gear-box. The bearings and nuts and bolts are off-the-shelf metal parts, but everything else is good old hot melted plastic. Because of the need for structural strength, Brocken recommends printing the gear-box and shredder with at least 25 percent infill, but you can fill yourself in on all the details, and watch the machine in action, below. □

➔ hsmag.cc/3DShredder



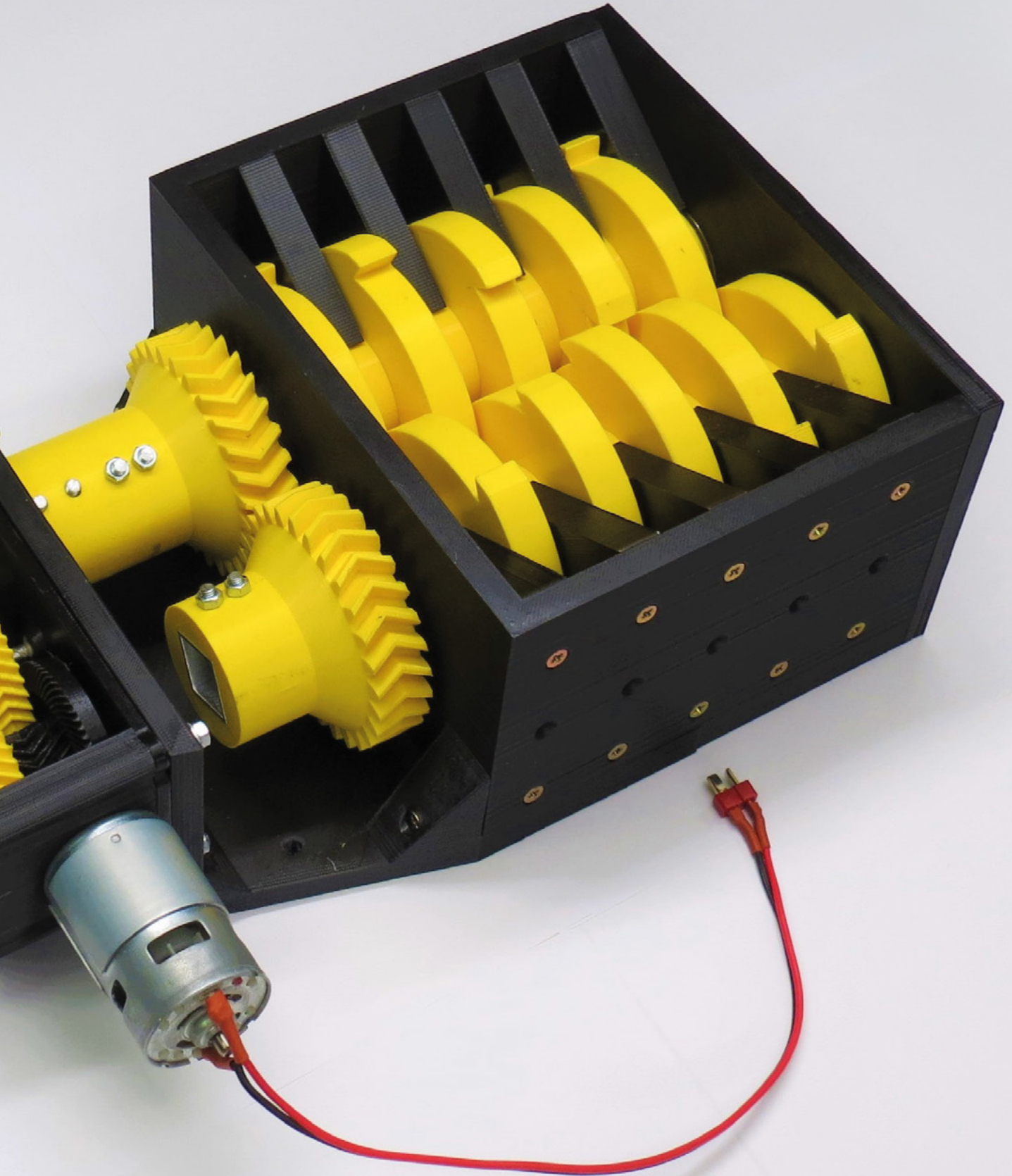

Meet The Maker: Billie Ruben

Have nothing on your 3D printer bed that you do not know to be useful or believe to be beautiful

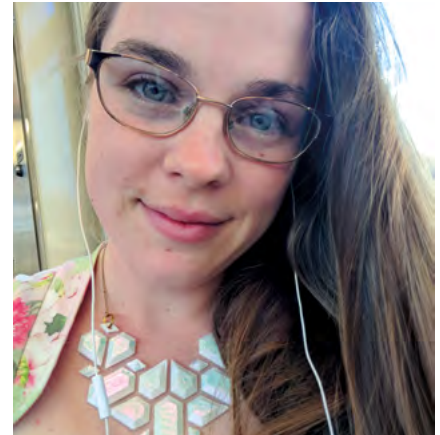

When we discovered 3D printing a few years ago, it was a sea of beige and grey plastic, with stringy bits, rough bits, and bits that didn't quite fit.

That we've moved so far forward in recent years is down to the work of many people, one of whom is Billie Ruben. As one of the moderators on Reddit's largest 3D printing forum, she has quietly steered new users in the right direction, away from the frustrations of wonky print beds and too-cold hot ends, and helped open up the craft to a new and growing audience.

" I like blending 3D printing with traditional media as well. I do a lot of printing on to fabric, and I make little bits for costumes

She's also pushing the boundaries of what can be done, by coming at the technology from a different perspective to most users. We caught up with her from an appropriate social distance (the other side of the world) to ask her about all this and more.

"My parents are both creative in their own ways. They used to run a clothing company when I was a child, so I was always surrounded by textiles. And my mum is a fine artist, so yeah, I was always around art and design. When I left school, I took an apprenticeship at a theatre company and learned costuming, which was really cool and I really

enjoyed. They take on an apprentice every year to keep those skills going, because they're a bit different to fashion – there are a few things that are specific to theatre.

"I also studied millinery [hat-making] as part of that as well. I've always loved historical costume; old dresses and costumes are really inspiring.

"I've always done things like knitting, and any handicrafts, little bits of woodwork, I've dabbled in all sorts of things. I moved into digital fabrication a few years ago, because I wanted to make some crystal-shaped Dungeons and Dragons dice. I wanted to make those, but I knew I wouldn't be able to make them accurate enough with my hands. I investigated getting them 3D-printed, and it was too costly for just a random project idea.

"But then I found out that Aldi had a sale selling 3D printers one day for about \$400 AUD. I had no idea they were so cheap! I bought one that day and fell madly head over heels in love with the technology. In a relatively short time, I was helping to moderate the r/3Dprinting subreddit, which is the largest 3D printing community on earth after Thingiverse. It became my whole world.

"I like blending 3D printing with traditional media as well. I do a lot of printing on to fabric, and I make little bits for costumes, and tools to help me make costumes as well.

"I quite like functional stuff. I recently made a watercolour palette, for example, because I decided I wanted to learn watercolour and gouache and stuff. And I used fabric print actually in a functional way to make the hinges for that pallet for the lid and stuff. →



Above 71
This headpiece blends millinery skills, 3D printing, and a design by English artist William Morris



“If the hinges were plastic, they would break within a couple of weeks; because they’re fabric, they can bend and bend and bend.

“I think 3D printing is often seen as a pretty thing, but it can be quite functional too – the fabric is what makes this hinge so flexible and so durable. If I’d just plain 3D-printed that, it would break within a few uses probably, even in PETG.

“\$400 for a printer is ridiculously cheap. And it came with a three-year warranty as well, which in the 3D printing world is practically unheard of. I actually had something break on that machine, and I got it fixed no

bother; they paid for all the shipping as well. I don’t know how they’re making their money, but it’s a great machine, a little Wanhao D6 clone. That’s what I learned on. I have other ones now, but that’s what I learned on.

“I don’t moderate it any more, but when I did – before I did really – I faced discrimination for my gender. Like, bad enough to realise why I needed to take a stand. Before that I was like, ‘Oh, feminism’s important, but oh well, whatever. It’s ticking along fine without me. It’s hunky-dory’. I was treated so differently, and so poorly by some of the other people



Right ◆
3D printed feathers are a lot more ethical than the real thing

“
—
When I came to moderating, I really wanted to encourage people to be empathetic toward each other
—
”

on that subreddit, that it made me realise how bad it could be. When I came to moderating, I really wanted to encourage people to be empathetic toward each other. My motto was always ‘Remember the human and be excellent to each other’. When I left, there were hundreds of comments from users saying how much they appreciated my moderation style. I take

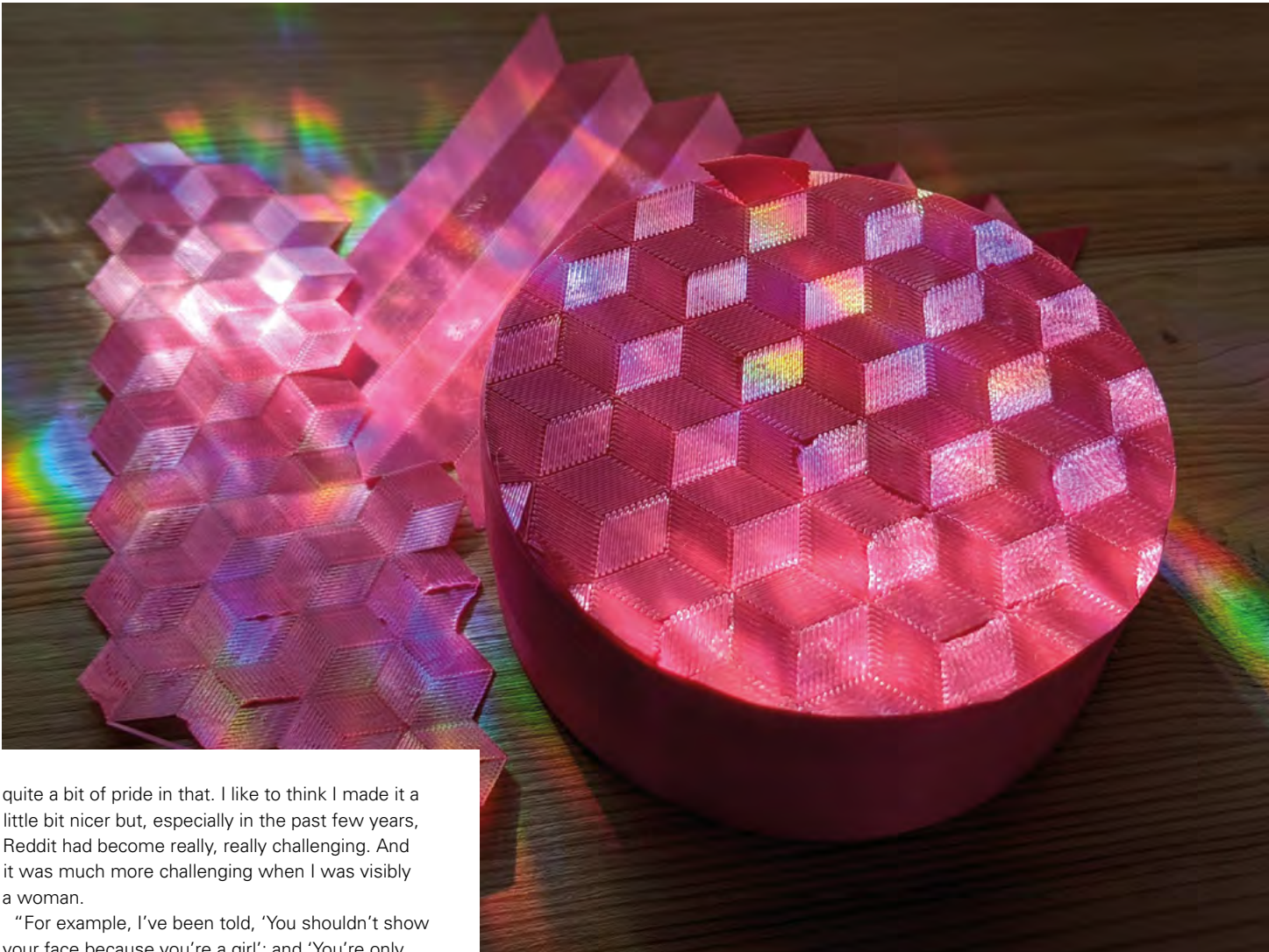

quite a bit of pride in that. I like to think I made it a little bit nicer but, especially in the past few years, Reddit had become really, really challenging. And it was much more challenging when I was visibly a woman.

"For example, I've been told, 'You shouldn't show your face because you're a girl'; and 'You're only doing this for attention'. This, despite the fact that the whole of Reddit, it's based on attention – that's literally how the karma system works. Literally anybody who posts anything is doing it for attention.

"But I'd get called out, even if it was just my hands in a picture holding something, because my long fingernails made it obvious that I was a girl, so I was just seeking upvotes. Oh my lord, really!

"But that's only a really small minority of people who are hideous; the vast majority are lovely. I think that's the same in any society; it couldn't function if most people were terrible. I take great pride in the knowledge that many people really liked what I did there. I think I did well as a moderator; I got that feedback, so I should believe it.

PUSHING THE TECHNOLOGY

"I've done three posters to answer common questions, and I've got a couple more in the works. I've done one on levelling, how to level your 3D print bed. →

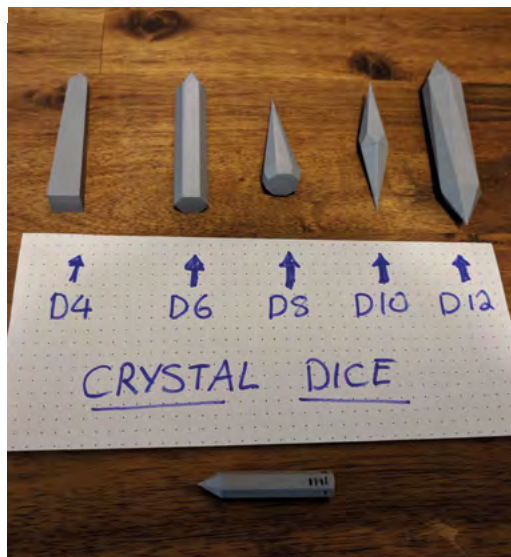

Above ♦ This surface is flat, but looks textured thanks to the way the toolpath has been forced to trace a pattern on the surface of the print

Left ♦ Where it started...

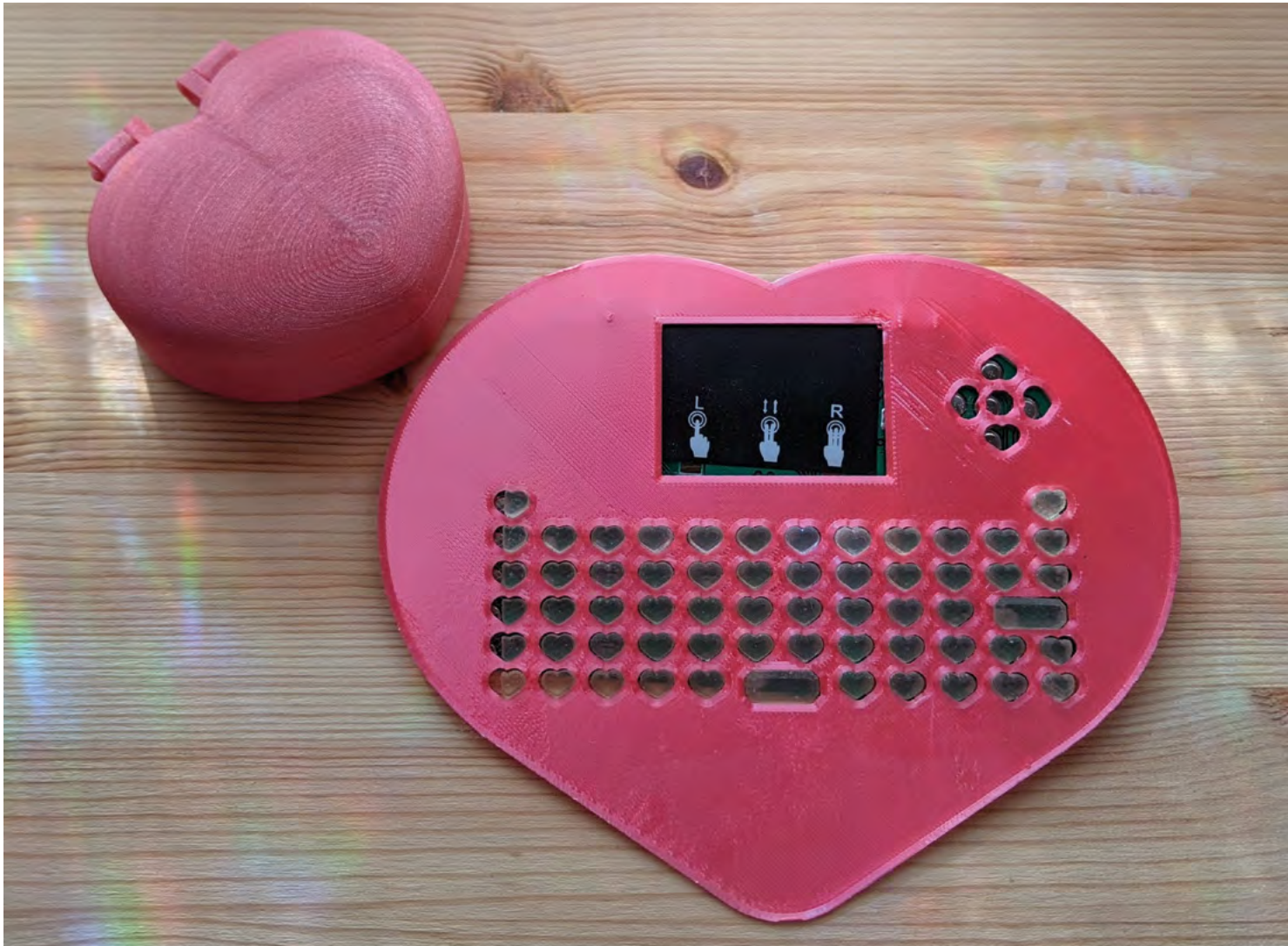

// A little while ago, I started working on a felt 3D printer that would print felt instead of plastic. I'm still sort of working on it

//

One on what software to use to create 3D models depending on what you're trying to do; another one on CAD tips, different ways to model things specifically so they suit 3D printing as a technology. That was born out of Reddit: I saw lots and lots of different questions from people – well, lots of the same question really.

“And so, I made those guides to help answer those very same questions, particularly the levelling and the ‘what program should I learn.’ At one point they were every second question we were getting on the subreddit.

“I have recently worked out how to 3D-print feathers. This is a neat little slicer trick to be able to make these. They act very much like real feathers; I printed all these straight, but I'm able to bend them by hand like you can with normal feathers. And I really like them because they're quite ethical. The feather trade is very similar to the fur trade, and for that reason I haven't bought feathers in a really long time, even though I like making hats and stuff. But the ethics around it are a bit dodge. So I'm pretty excited to be able to work with feathers again, any colour or size that I want. I reckon cosplay wings would be super-cool too, that's what I'm excited about at the very minute, but there are things that I'm getting excited about all the time.

“A little while ago, I started working on a felt 3D printer that would print felt instead of plastic. I'm still sort of working on it. I flip between projects that have been on the back burner for a while. There's this

Above ♦ Mechanical keyboards are another of Billie's fields – this one is an adult-sized, functional version of the Polly Pocket toy



process called needle felting which uses a needle that has tiny little downward-facing barbs on it. You poke it into loose wool, imagine the wool you get off a sheep. It tangles those fibres together and by poking it in certain directions, you can form 3D objects. I thought: 'What if you could do that with a 3D printer?' You could have it extruding wool and felting it together with a felting needle. I made a little tool head and moved it around with my hands in the way that a 3D printer would move, and it worked. I just need to put it onto a printer and make a bit of a post-processing script so it will do the jabbing motion and everything.

"3D printing is mostly rigid materials, and where there are soft materials, they're soft and rubbery. There's nothing cuddly or warm that you might want to curl into at the end of the day. I get so excited at the prospect of teddy bears, or custom insoles for your shoes, or custom pillows that are exactly made for the way you sleep. It would be such a cool technology to explore. Maybe I need to bring that one back out of the chest of not-quite-forgotten projects.

"I can't see why it wouldn't work. It worked by hand, and all I have to do is get the printer to do the same motion my hand does, so I think it should work.

"So this is a recent project – I found a way to force the tool path to make interesting textures on flat surfaces, which I thought was pretty neat, especially as you can't do that with any traditional media; you can't put a glitter on there and have it end up looking like this.

"The printer head goes in all sorts of directions, and that creates this cube pattern. I've made a YouTube video – it makes more sense on there than trying to

explain it here. There is an SVG to G-code converter I originally started writing, but then someone else wrote the same thing, and probably better than me, because I can barely code. So I use their one, built into Cura.

"There are some skills I'm pretty good at, like sewing. I've probably maxed out that skill tree, or near to it. Coding – probably not so much. I could probably cobble something together. And I did get the SVG to G-code thing mostly working before I discovered somebody else had already done it. I've shown it to other people who can code and they're like, 'This is fine'. So I guess it's alright, but I would probably have a hard time picking it up again. The only thing with coding is that you have to get it 100% right or it doesn't work; with most other tools, you can get things 90% of the way there and you'll still get a result, but with coding you get nothing. It's so punishing.

"I came from such hand-crafty stuff. I've always been strong at Photoshop, and Illustrator, and stuff. But yeah, anything electronic is just foreign to me entirely. I'm, thankfully, surrounded by lovely people who are willing to help me learn, but it's just taking the time to do it and get stuck in.

"You've just got to find your tribe, right? The maker community is great. It's very homey.

"I think we've seen that this year more than ever, especially in 3D printing with the PPE side of things, people just selflessly printing PPE with their own filament and not asking any money for it. The community is great, and that's what brought me back when Reddit was hard." □

Below ♦
Billie's working on a way to 3D print solid shapes out of unspun wool



Making for animals

Fabricating for our friends with fur or feathers



Lucy Rogers

 @DrLucyRogers

Lucy is a maker, an engineer, and a problem-solver. She is adept at bringing ideas to life. She is one of the cheerleaders for the maker industry, and is Maker-in-Chief for the Guild of Makers: guildofmakers.org

A **ny unscheduled trip to the vet this month (my dog was attacked by another – she’s OK now but I’m still fuming), got me thinking about making for animals.**

Social media is full of cats and dogs wearing the ‘cute’ outfits that their owners have made. This even extends to the occasional hat-wearing owl. I’ve also seen automatic pet feeders – mainly for cats, but also a sunflower seed dispenser for a hamster.

But I started thinking more about how animals are being helped, which started me off down a (metaphorical) rabbit warren of Googling. I found all sorts of 3D-printed prosthetics – from a bright yellow beak on an eagle, to ‘spare’ shells for hermit-crabs. I thought small animals and birds may be the only ones to benefit – but there’s also a dolphin with a new tail, and an elephant with a new front leg. Admittedly, that was a metal structure bolted together, rather than made on a home PLA 3D printer.

As well as making something for an individual animal, there are a lot of ‘makes’ that are helping the farmers and keepers of herds, flocks, and swarms (sadly I couldn’t find anything that is helping crows, as I wanted to use the collective term ‘murder’ in here).

Nyalas (a type of antelope) in Marwell Zoo are being kept cosy more cost-efficiently by harnessing machine learning, thermal sensors, and a Raspberry Pi. The sensor takes an image of the bedding area, and the machine learning works out whether there’s a nyala there. If there is, it switches the heater on; if there’s not, it turns it off.

Sheep rustling (as in stealing, not making a crunching noise) is causing problems for farmers. A swallowable ‘pill’ containing an electronic identification device has been

designed to help recover these animals. It stays in the sheep’s rumen – and doesn’t get digested. Because of the play on words, I have always been amused by the term ‘rustling’, but in the UK, livestock rustling is estimated to have

cost the UK rural economy £2.5m in 2018.

Bee-keepers have also turned to tech makes. Temperature, mass sensors, and a connection to the internet can help the bee-keeper know if something is wrong with the hive, without having to open it up. Bees keep their hives at a pretty constant temperature. If it suddenly changes, there may be something wrong. Similar with mass – if the hive suddenly gets heavier, there may be an infestation of mites. Both of which are worth checking.

And don’t get me started on the robot dinosaurs at a theme park on the Isle of Wight ... □

There are a lot of ‘makes’ that are helping the farmers and keepers of herds, flocks, and swarms

RISC-V goes mainstream

One step closer to completely open computers



Drew Fustini

🐦 @pdp7

Drew Fustini is a hardware designer and embedded Linux developer. He is a board member of the Open Source Hardware Association and the BeagleBoard.org Foundation. Drew designs circuit boards in KiCad for OSH Park, a PCB manufacturing service, and maintains the Adafruit BeagleBone Python library.

Back at the beginning of this year, I wrote a column about RISC-V, a free and open instruction set architecture (ISA) created by researchers at UC Berkeley. An ISA

specifies the tasks that a processor can perform, like a contract between the hardware and the software. RISC-V has had a lot of successes over the course of 2020, including a number of organisations who have taken this open-source standard and put it into practice in all sorts of exciting ways.

One of the companies that I've been keeping an eye on is SiFive, a startup founded by some of the original team behind RISC-V at UC Berkeley.

SiFive has a similar business model to Arm: it designs processor cores that companies such as Microchip license for their own chips. Unlike Arm, SiFive is implementing an open instruction set architecture.

Recently SiFive hit the news, announcing a global partnership with the BBC on its new STEM education development board: the BBC Doctor Who HiFive Inventor board. This hand-shaped board is part of a kit that teaches children to get started with programming and electronics, including sensors, a colourful, blinky LED matrix, buttons, a speaker, connectors, and both WiFi and Bluetooth connectivity. The kit also comes with a set of lessons voiced by the thirteenth Doctor, Jodie Whittaker.

This is a high-profile win for SiFive, as this kind of board would normally be based around a chip with an Arm core. Winning over the BBC for a project like this shows that SiFive has become a company that can compete with the chip design establishment, and it also shows that RISC-V is now mature enough as a standard to form a basis for mainstream products. SiFive has also been busy in other areas, including its new RISC-V PC based on the HiFive Unmatched board. This RISC-V PC can run a full graphical Linux desktop environment – another big achievement for free and open hardware.

Looking forward, we are going to see RISC-V making inroads into the massive mobile market, with Samsung announcing that it will use SiFive RISC-V cores in upcoming chips for use in 5G smartphones and AI image sensors. We will also see makers using RISC-V in

Looking forward, we are going to see RISC-V making inroads into the massive mobile market

lots of IoT projects thanks to Espressif, which is well-known for making the ESP8266 and ESP32 chips that ushered in a new age of low-cost WiFi. Espressif has now announced that it is making the ESP32-C3, a new generation of cheap WiFi chips that are powered by a 32-bit RISC-V core. It's exciting to watch this free and open standard graduate from research departments and startups to global institutions and manufacturing giants, ending up on workbenches and desks at hackerspaces and schools all over the world. ▣

Letters

ATTENTION ALL MAKERS!

If you have something you'd like to get off your chest (or even throw a word of praise in our direction), let us know at hsmag.cc/hello

THANK YOU LORD SUGAR

8 Tips for Turning an idea into a Business – I wish I'd read this last year! Seriously, it would have saved me a lot of hassle, as I tried and failed to sell things that I thought were cool, but it turned out the rest of the world didn't agree with me. At least, that's what I thought. Funnily enough, I never bothered with reading any other business guidance, as I figured open-source hardware is just too different from most other things for the old rules to apply. Now that I've seen things from his perspective, I can see a few things that I did wrong, I'll have another crack at it.

Paul

Dover

Ben says: Business is hard when you're doing it right, and even harder when you're doing it wrong. Matt Bradshaw has a great product in his DrumKid random number-based drum machine, and we're lucky he was willing to share how he's been getting on with the mystifying business of selling them to strangers over the internet.

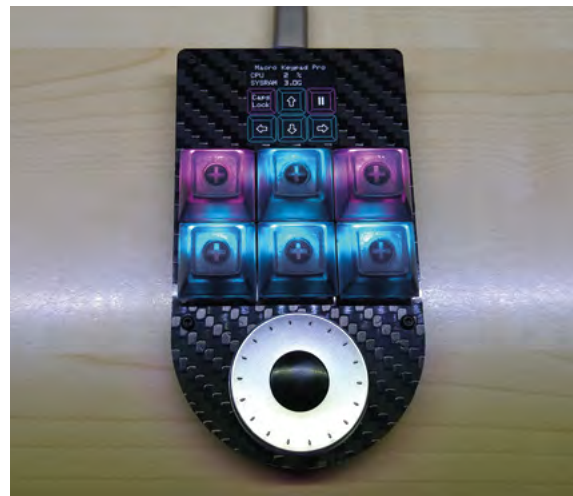

SEEING DOUBLE

The roundup of your favourite kits from Tindie was interesting – I note that one of the products in there [the Macro Keypad Pro by Phoenix CNC] was featured twice in the magazine. Did you really love it that much?

Joan

Yorkshire

Ben says: We liked it! We've often thought that the standard keyboard/mouse/screen interface is a bit lacking. Games have all sorts of ways around this, from joysticks, gamepads, and Nintendo Wii-style nunchucks through to custom builds, like the many controllers that people make for Kerbal Space Program. The Macro Keypad Pro gives you the ability to add custom functions to your setup depending on what application you're using, and it looks cool too. We think that's worth shouting about.

PAPER ENGINEERING

One upside of the recent months in our house is the sheer amount of cardboard we've got to play with after all the deliveries we've been getting. Even the tiniest product seems to come in a massive box, presumably to make life easier for the person in charge of box buying. After reading about Rob Ives [in issue 37] and his cardboard engineering, I'm turning all the cardboard I've kept for a rainy day into gears, cams, screws, all sorts! At this rate, I'll be able to build enough automata to convincingly replicate a Christmas party with all the people I won't be able to see this year.

Keith
Scotland

Ben says: The magic of paper is that it's cheap. This makes cardboard, which comes through the post when you buy things off the internet, even more magical because it's free. We've made an insulated yoghurt maker in the not-too-distant past with excess packaging, though we've yet to venture into anything mechanical. Have fun!



CROWDFUNDING NOW

Pixelblaze V3

WiFi-controllable lights

From \$35 | crowdsupply.com | Delivery: February 2021

Pixelblaze has been around for many years as a WiFi-enabled controller for chainable LEDs. The firmware takes care of most of the setup – plug it in and it creates a WiFi network that lets you enter the credentials for your main WiFi network. Once it's connected, you get a web-based programming setup where you can use JavaScript-like code to program the patterns. If you want your lights to respond to the environment, you can add a sensor board which includes audio input (which can provide 32-band frequency data), a three-axis accelerometer, an ambient light sensor, and five analogue inputs.

There's also a Pico option, which scales everything down to the form factor of an LED strip. The outputs line up, so you can solder the Pixelblaze Pico straight onto your LEDs.

While you can drive a few thousand LEDs from a Pixelblaze (note that you'll need to think carefully about your power supply setup if you're planning on using this many LEDs), the rate at which you can update the pixels goes down as the number of pixels goes up, so if you want large numbers of pixels and

smooth animations, you may want to consider the output expander add-on, which has eight outputs for you to split your LEDs between.

We've used and enjoyed the Pixelblaze V2 previously, and the V3 looks like it includes a great set of improvements – the biggest one being the boost in processing power from an ESP8266 to an



We're excited to see what the new processor capabilities mean for this device



ESP32. While we haven't had a chance to get our hands on it yet, it looks like an evolutionary increase in specs rather than a revolutionary new product. Given that the Pixelblaze V2 is already a great device, we're excited to see what the new processor capabilities mean for this device. □

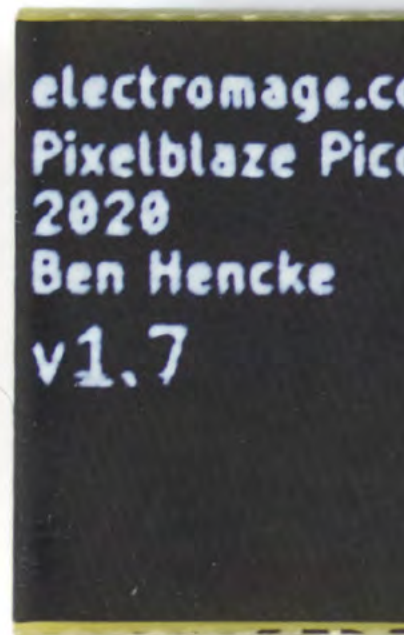
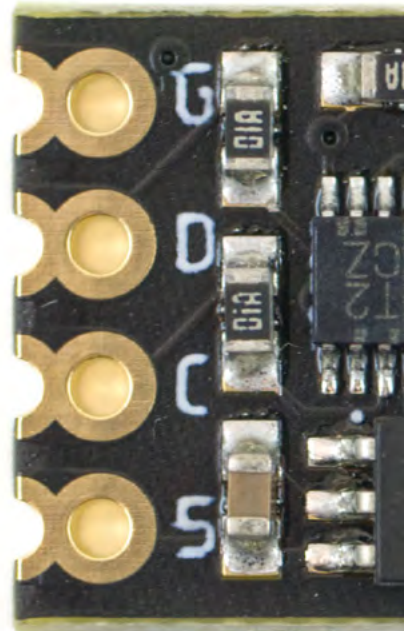

BUYER BEWARE

When backing a crowdfunding campaign, you are not purchasing a finished product, but supporting a project working on something new. There is a very real chance that the product will never ship and you'll lose your money. It's a great way to support projects you like and get some cheap hardware in the process, but if you use it purely as a chance to snag cheap stuff, you may find that you get burned.

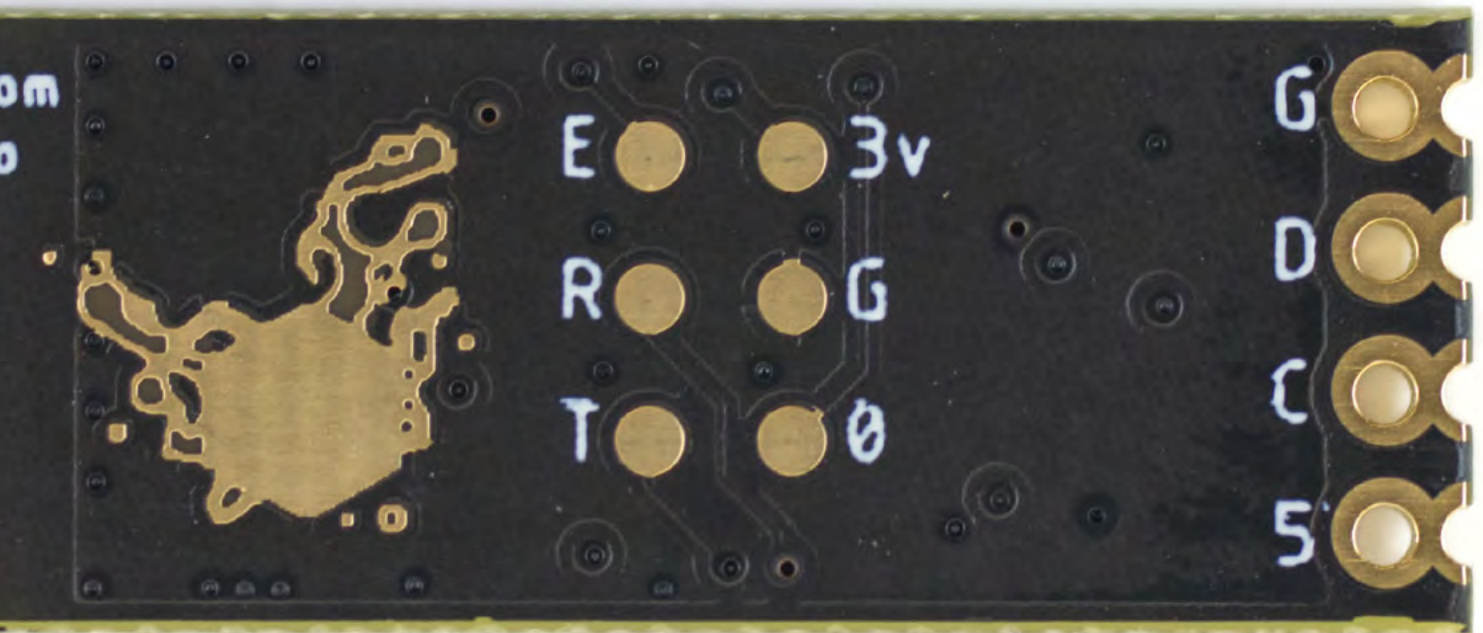
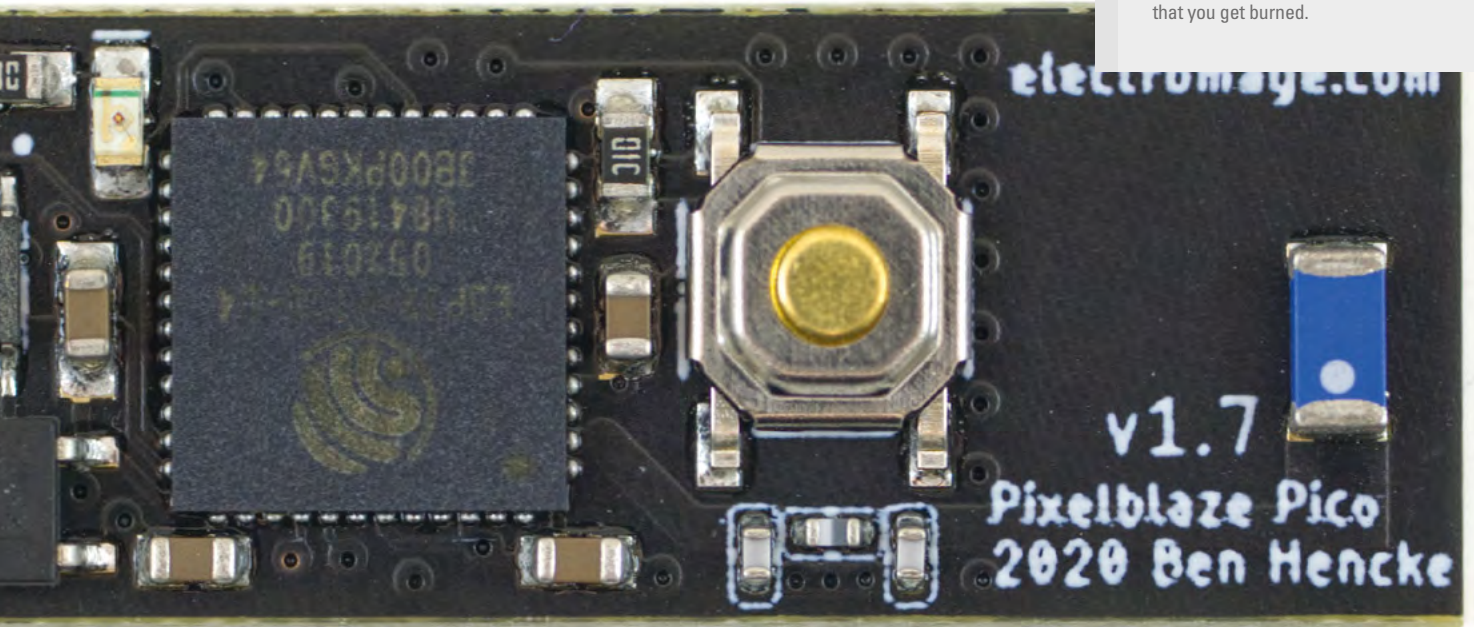

Community spotlight: Hackoustic



Hackoustic

hackoustic.org

hackoustic

@hackoustic

Hackoustic is a community group dedicated to hacking sound, building instruments, and providing a platform for artists, engineers, and scientists to show their work.

They formed in 2014 at the London Hackspace as a place to experiment with acoustic sound and physical interfaces; anything involving more than a laptop/modular synth and speakers. They run all sorts of inspirational events at art galleries, hackerspaces, and music venues, including Hackoustic Presents: part show-and-tell, part performance, and part sound hacker meet-up.

As well as providing time and space for established music hackers to learn from each other and share their work, Hackoustic is extremely friendly to the curious but uninitiated. There are lots of awesome people that are part of the big, nerdy, noisy Hackoustic 'family', from more traditional instrument makers to sound scientists and performance artists. Here is a taster of the kind of work you could expect to see from them. □

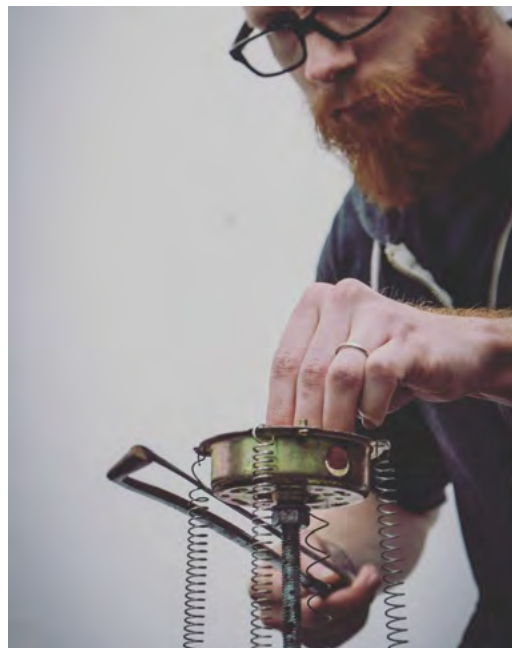

Tom Fox Springything

Tom Fox is a teacher, instrument builder, and artist. As well as being the creative director of Hackoustic, he runs a project called Vulpestruments that explores reclaimed materials, odd bits of physics, and scraps of technology to explore new methods of sound creation and interaction.

One of the objects that came out of the Vulpestruments project is Springything, an experimental instrument made out of springs, magnets, a coil of wire, and an amplifier. The range and variety of noises and sonic textures that Fox manages to coax out of this relatively simple instrument is extremely impressive.

vulpestruments.com



Tim Yates The Big Blade

Tim Yates is a sound artist and musician who makes, builds, and finds instruments of all kinds for performance and installation. He is the founder and director of Hackoustic, and also works at Drake Music, developing new and bespoke musical instruments and interfaces for people with disabilities.

The Big Blade is a giant gong made out of a 1.2m diameter industrial circular saw blade and wooden stakes, played with a number of different implements. The instrument's sound is as epic and spectacular as you'd imagine, leading to queues both times it was shown – and made available for the public to play – at the Tate Modern.

🔗 timyates.net



Jen Haugan Doppler Machine

Jen Haugan is a designer and creative technologist who likes to make real-world, tangible experiences using light and sound. While she was at the RCA in London, she developed a series of sonic objects that modify sound in different ways.

Her Doppler Machine uses the Doppler effect as a playful way to create new sounds. Haugan uses her instrument in combination with feedback and external microphones, leading to ephemeral, alien soundscapes. You can also play music through the Doppler Machine to produce interesting effects.

🔗 jenhaugan.com



Adrian Holder Object Project

Adrian Holder, also known as *Precis*, is a sound and visual artist who processes real-world sounds using anything from a hacked radio through to software such as *Max for Live*. He works with a wide range of musical genres, and likes to play with the balance between audio and visual perception.

For the *Object Project*, Holder hacked a turntable so that it not only plays sound the traditional way, with a needle, but it also produces music and tones by striking its surface. The turntable also reads the shape, size, colour, and movement of objects placed upon it. He uses *Ableton Live*, *Max for Live*, and modular synthesis for audio processing.

➔ hsmag.cc/Precis



Mother Disorder Crystalline

Mother Disorder is a performance artist and sound hacker whose works often draw from lived experiences with mental illness and neurodiversity.

Mother Disorder uses contact microphones attached to the body for the sound art performance piece *Crystalline*. *Crystalline* was developed in response to societal pressures to be functional and the process of therapy for mental disorders. During the performance, foreboding electronic music is generated and looped, accompanied by the sounds of the contact microphone 'skin' being shed in front of the audience.

➔ motherdisorder.co.uk



Brendan O'Connor Sound Stitcher

Brendan O'Connor is a musician and designer of interactive sound installations with a background in classical performance and electronic composition. O'Connor is currently researching AI technology and the singing voice as part of his PhD at Queen Mary University of London.

Sound Stitcher is an interactive vintage sewing machine. Turning the wheel generates digitally amplified sewing machine noises, while interacting with its levers, sliders, and clips cause the sounds to distort and degrade, mimicking the state of this defunct and venerable piece of machinery.

➔ soundcloud.com/brendanoconnormusic



CONTACT US

We'd love you to get in touch to showcase your makerspace and the things you're making. Drop us a line on Twitter [@HackSpaceMag](https://twitter.com/HackSpaceMag), or email us at hackspace@raspberrypi.org with an outline of what makes your hackspace special, and we'll take it from there.



Build a Makerspace for Young People

Join our **free online training course on makerspace design** to get expert advice for setting up a makerspace in your school or community.

Sign up today: rpf.io/makerspace

LENS

HACK | MAKE | BUILD | CREATE

Uncover the technology that's powering the future

PG
50



INTERVIEW: PETE WOOD

DesignSpark's representative on Earth talks boats, buses, and space balloons

PG
60

IMPROVISER'S TOOLBOX:

KEYS

Do something useful with the bits of shrapnel in your pockets

PG
64

CHRISTMAS BUILDS!

Whether you've been naughty or nice, you can always make something entertaining



PG
38

RE-MAKING MOVIES

How DIYers recreate props, costumes, and memorabilia





Inspiration can come from anywhere. Every day we are inspired by the wonderful community of makers all over the world. Movies, though, have long been a great source of inspiration for many. In fact, the quest to bring reel to real has inspired a great many technological inventions. From mobile phones to video calling, virtual reality to self-tying laces, and hoverboards to driverless cars, we have long drawn inspiration from the world of make-believe.

But it's not just technology that drives the innovators' passions. More often than not, it's the challenge of replicating a costume or a prop that catches their fancy. It really isn't a surprise since many of these props, such as Iron Man's armour, or the Ghostbusters' Ecto-1, have a fan following all of their own.

In fact, back in the heyday of *Knight Rider*, conversion kits were all the rage and people around the world lined up to transform their Pontiacs to resemble the iconic KITT. Others installed the breathing red lights on the front of their stock vehicles to express their love for the talking car. A similar frenzy erupted with the release of the *Fast & Furious* franchise, which resulted in a surge in the sale of under-car lighting equipment.

Investing time and putting in all the effort to create a replica might sound like a silly endeavour to some. But at the root of these undertakings is the passion of the maker to identify themselves and connect with something they've seen on screen.

Over the next few pages, we feature fans of various franchises who channel their inner geek and put in a lot of time and effort to make some awe-inspiring creations. We'll showcase some of the best replicas of wearables, costumes, vehicles, and more that you've seen in the movies. These projects are the result of lots of painstaking labour, a hefty dose of passion, but above all else, a desire to innovate with nothing but your own wits to drive you forward. →

PROPS

Own a piece of the cinematic universe

◆ Mark's TARDIS is powered by an Arduino and a couple of Raspberry Pis, one of which runs a Python script with a Tel GUI to control the prop

Props play a vital role in cinema. If used properly, not only do they help the audience understand the narrative, but they also make a scene feel authentic, and even help actors enhance their performance. Props serve as the extension of a character's personality, and are perhaps one of the best ways for fans to get a feel for the role.

Hobbyist woodworker, Peter Brown, collaborated with pocket83, another prolific maker, to create a replica of the amber cane (you can see the build at hsmag.cc/AmberCane) used by John Hammond in *Jurassic Park* (portrayed by Sir Richard Attenborough).

BUG ME NOT

The amber topper was two years in the making, primarily because of the scarcity of the right kind of bugs to 'amberise' by the time Peter had perfected the curing procedure. Making the casting is a major endeavour, and it took Peter about ten castings to get everything right.

Once it was set, he mounted the cast on a wood lathe and carefully shaped it, which is again a painstaking task. The polyester resin is too brittle to work with, which is why Peter's final cut, even after all the sanding, isn't as spherical as the one in the movie: "I really do think that polyester resin is the best choice for this build, even though the stuff is awful to work with. It just polishes up so nice!"

When it was done, he sent the topper off to pocket83 to mount it on the cane: "I get asked pretty often what my favourite piece I have made is. I used to say I didn't know. But when we had to evacuate our house in 2017 for a wildfire, my wife grabbed our tax documents, pictures of our children and we all got in the car. She asked me if we got everything, and I had to confess that the only thing I did was wrap up the cane and got it safely aboard."

TARDY TIME TRAVELLER

The TARDIS time machine from *Doctor Who* is another iconic prop that is instantly recognisable. This also makes it extremely popular with makers. What separates Mark Rasmussen's rendition (take a look here for the full build: hsmag.cc/TARDIS), however, is that it's the result of obsessing over





◆ While this looks like a hardware project, much like the real Enigma, the brain of this replica is actually software

details, like getting the exact Pantone colour: “no need to criticise other people’s hard work, but there’s a bit of pride knowing you got the font right, for example. Obsession makes all the difference.”

Mark was determined to have it ready for that year’s San Diego Maker Faire and, despite all the woodworking, he completed the build in under five weeks: “You’ll never get it 100% exactly like any given TARDIS model, so you have to borrow the features that appeal to you. But details like fonts, colour, and proportions are absolutely key. I got pretty good at knowing what a good TARDIS model should look like.”

While Mark’s TARDIS doesn’t fly you through time and space, here’s a prop that’s functional and takes you back in time. Co-owners of S&T GeoTronics LLC, James Sanderson and Marc Tessier built a replica of the Enigma M4 encrypting machine (hsmag.cc/EnigmaMachine) for an event. But it wasn’t until they published the detailed instructions on Instructables that their product received worldwide fame.

Their fully functional replica, dubbed Open Enigma, uses an Arduino Mega to crunch numbers. Thanks to the overwhelming response from the community, the duo launched a Kickstarter campaign



to offer sophisticated kits and assembled units of the Open Enigma, which overshot the target by 300% in under a month.

The build involves a lot of parts and isn’t for the faint of heart, although Marc tells us you can make your life a lot easier by using their inexpensive PCB. The duo love replicating classic computing devices. Besides the Enigma, they’ve made a replica of the Apollo Guidance Computer (AGC) Display Keyboard (DSKY), which is seriously cool.

ARMED AND DANGEROUS

One prop we’re glad is just a prop is Karthik PB’s replica of the throne from *Game Of Thrones* (hsmag.cc/IronThrone). Instead of swords, the build uses lots of cardboard, tissue-paper rolls, plywood, cans of paints, and a chair. A recipient of the prestigious Red Dot Design Award in 2017, Karthik worked on the project while pursuing a master’s in Product Design: “To replicate the project, one should have patience, as it takes time in making lots of individual parts and joining them.”

In contrast, Rob Bonifacio loves building movie props that feel and look as if they are the real thing, which is why he’s used a bunch of steel tubes and sheets to create a replica of the blaster from *The Mandalorian* (hsmag.cc/Blaster).

Fabricating the replica took him over two months: “It consisted of many different types of metals like aluminium, steel, and stainless steel, and many different types of fabrication processes to achieve the look I wanted.”

Rob also taught himself some new skills such as cold-forging the rail sight on the top of the blaster to make it look more authentic: “I encourage anyone to try props like this to experiment with fabrication processes like I did, no matter the outcome. If you stick with it, you will get better.” →

◆ Rob’s preparing to use everything he learnt while creating the blaster, to build the IG-11 assassin droid from *The Mandalorian*

▣ Creating different-length cardboard swords was one of the major time-consuming tasks of the build



WEARABLES

Get a feel for your on-screen hero

Most props help recreate the ambience of a movie. But some go a step ahead and help define a character itself. For instance, there's Tony Stark's arc reactor that not only powers his suit but also keeps him alive.

In fact, Paul from ShareAHack has 3D-printed himself a wearable arc reactor (hsmag.cc/ArcReactor). He's inspired by Iron Man, who Paul considers as pretty much a maker himself, and has always wanted to build an arc reactor he could wear under a shirt. The unique thing about Paul's wearable arc reactor is that it allows five interchangeable designs.

Besides the 3D-printed designs, the build also requires two different-sized LED rings, plus a couple of other things. After printing the 3D parts, it should take you less than two hours to put everything together.

PICK UP THE GAUNTLET

In addition to sharing the 3D STL files for all the parts, Paul has also shared an extra design for the diffuser that can accommodate LED lights of any size. Paul advises anyone who's starting with 3D modelling not to be intimidated: "When you have an idea for something, the best thing you can do is 'just start'. Don't worry so much about how you're going to do it – those details will come. Use all of the tools you have at your disposal and then learn as you go."

Another defining cinematic prop is the Infinity Gauntlet from *Avengers: Infinity War* that Michael Darby has made into a wearable (hsmag.cc/Gauntlet). He used a run-of-the-mill Thanos Gauntlet from a costume shop and then equipped it with an Arduino Pro Mini, some different coloured LEDs, a couple of buttons, and a bunch of other electronics.

Michael initially wanted to get the LEDs under the stones in the glove, but couldn't since they were opaque on the inside. He's also glued a button to one of the fingers and the thumb. The finger button can either cycle through each of the LEDs or turn them all

on, while the button on the thumb lights all the LEDs, just like Thanos's snap.

When he started out, Michael wanted the gauntlet to be an aesthetic-only project that one could wear on Halloween. But then he decided to use the glove to wreak Thanos-like havoc, by eradicating half the artificial life he'd created in an earlier project (hsmag.cc/ALProject), every time the button on the thumb was triggered. The finished product lights up just like the real thing, and unfortunately for the artificial life forms in his other project, does pretty much the same damage.

Bryan Bales is also fascinated by things that terminate life, or rather, the undead. Creating a replica of the Proton Pack from the 1984 *Ghostbusters* (hsmag.cc/ProtonPack) has been on his to-do list for over a decade.



◆ Michael wished the build was tidier than it is, but thinks the LEDs will outshine the messy wiring



He's used EVA foam mats, wooden dowels, and various PVC pipes and fittings to painstakingly create all the components that go into making the Proton Pack: "I also spent a lot of time on the front end converting existing CAD plans into working templates, which took a bit of trial and error for some parts." Very helpfully, Bryan has shared all his templates that anyone can use as-is or even modify them as per their requirements.

HEAVY LIFTING

While it might look like a rather straightforward build, it isn't: "There seems to be an infinite amount when you consider the Proton Pack, Neutrino Wand, and ALICE Frame. I found breaking it all down into a list made it more manageable. Fabricate one part at a time and keep adding to the overall puzzle."



Make-up artist extraordinaire Allison Chase has had her work featured in fashion shows and various film projects. Allison, who majored in theatre, also likes to replicate props from movies. Her fully mobile replica of the Power Loader from *Alien* (hsmag.cc/PowerLoader) is breathtaking.

Allison says that the majority of this entire build was created with insulation foam from The Home Depot, and took her about seven weeks to complete. The entire thing is based off stilts: "I'd been wanting to do cosplay with stilts for a while, so the Power Loader idea actually evolved around the stilts rather than the other way around."

Even before starting out, she knew she'd have to trade film accuracy for the sake of practicality. She wanted to move with the Power Loader at a decent speed, which is why she wanted it to be lightweight.

Again, this is another deceptively simple-looking build. Allison has done a great job of explaining the entire build process in great detail. Creating the various joints from the foam and fitting them all together is an involved process.

The hardest part, though, Allison says was the painting, as spray paint dissolves foam. That's why she had to apply multiple layers of Mod Podge to create a seal, before applying some foam primer: "Since I was worried the primer wouldn't be enough, I took it a step further and covered everything in a layer of acrylic paint." →



◆ He doesn't go to any Comic-Cons, but Bryan enjoys designing costumes for Halloween, and this one won first prize in Instructables' 2019 Halloween contest

▣ Paul is also working on fabricating an Iron Man Mark 1 helmet from real steel, to complement the 3D-printed arc reactor

◆ To make the Power Loader look more like a real piece of machinery, Allison literally punched it a few times to give it some scratches and dings!

COSTUMES

Become one with your favourite characters



▣ Instead of step-by-step instructions, Rick shares the principles involved in each step of the design process, which enables you to make any costume

Whether it's Halloween or Comic-Con, dressing up as your favourite character is perhaps one of the best ways to experience them and step into their shoes.

Of course, some costumes are easier to replicate than others. Rick Seroogy was impressed by his friend's costuming skills at last year's Halloween party. But it still took his friend eight months of coaxing and encouraging Rick to keep working on his Lord Marshal costume (hsmag.cc/RiddickCos) from *The Chronicles of Riddick*.

STICK TO THE PLAN

The costume is made of EVA foam, with some 3D-printed parts: "When I started the costume build, I tried to copy the Lord Marshal movie costume as close as possible, often becoming frustrated because it didn't look quite like the movie version. This goal was starting to take the fun out of the costume build," shares Rick.

Instead, he decided to "build the costume in the spirit of the Lord Marshal and make it your own." For instance, instead of adding a cape, Rick's version has a back-plate with the spine that's donned by the Necromonger Infantry. Rick advises wannabe makers to "be creative and have fun."

On the other hand, Joe Serrano takes pride in replicating every detail. Unlike Rick, Joe has been designing costumes since he was a kid: "I started very young with creating my own Halloween costumes. I figured I could make something better than what was sold at stores when I was a kid. It's probably been about 23 years now that I've been making costumes for myself and others."

As a child, Joe started making simple props with miscellaneous pieces of junk, cardboard, and superglue or Elmer's glue. He now works with thermoplastics, contact cements, and simple lighting and over the years has learnt how to sew, dremel, sand, and sculpt



◆ While Wolverine with a cowl has never appeared on the screen, they did allude to it in *The Wolverine*, which is why this costume makes the cut

◆ Gerald replicated the blue suit since it is in the movie but never worn by any character. The green helmet is a tribute to the one worn by Dr David Bowman when he disconnects HAL



to make elaborate costumes: “My advice would be to continuously challenge your skills. Never be complacent in where your skillset is because there is always room for improvement.”

Joe likes to do comic-accurate renditions and has shared detailed instructions for creating over 80 costumes. While he encourages people to just get started and not be afraid of trying new things, he does have a word of caution: “I suggest people need to be safe and conscientious about the materials they use: razors, chemicals, solvents, paint, dust, etc. I have ended up with cuts, burns, respiratory issues, all out of carelessness.”

RAISE THE BAR

Every maker seems to adhere to the philosophy of pushing themselves to learn new skills. Gerald Schaefer had just gotten into 3D printing about four months before he decided to take on the challenge of creating the spacesuit from *2001: A Space Odyssey* (hsmag.cc/SpaceOdyssey).

He's used the 3D-printed components to create the chest pack and the jet pack that are mounted on a mechanic's jumpsuit that was appropriately altered with some electronics. The chest pack powers the jet pack through a multiconductor cable. The thruster control is a four-way switch that will highlight the corresponding LED in the jet pack.

Gerald says he spent a ton of time scaling the components of the entire suit off movie stills, and pausing the movie he had on DVD to take measurements. He still got the measurements for the helmet wrong, which he soon corrected by creating a new helmet. He's also added a strobe light on top of the jet pack, which is not in the movie.

The whole build took Gerald almost a year to complete: “Think of the entire build as a collection of smaller projects culminating in a larger ‘epic’ result. This keeps one from getting overwhelmed and losing motivation to finish it.”

WHY RESIST?

Marcin Poblocki was all of six when he first saw *Star Trek* on TV and, like most of us, has been a fan ever since. *Star Trek* inspired Marcin to pursue a master's in Quantum Physics and Computer Science.

A few years back, Marcin (who now works at CERN on silicon detectors for the Large Hadron Collider) accompanied a friend to a Comic-Con. He was instantly hooked and started making costumes using his physics, 3D printing, and programming knowledge: “As my skills and experience grew over the last few years, I finally decided to have a go at making the Borg costume [hsmag.cc/BeABorg].”

Marcin assimilated the costume from motorbike armour, an Arduino Nano, some EL wire, and a bunch of 3D-printed parts. His advice to anyone looking to work with 3D printing is to be aware that you won't always get nice printed parts. He's got some tips for using them: “If your part fails halfway through a ten-hour printing, don't throw it away. Measure the height of the good half and then use slicing software to cut the model and just print the other half.”

He suggests you can then superglue the two parts together: “Occasionally I also use a 3D pen to extrude a little bit of plastic around the joints and then I smooth it with a soldering iron. This way you will reduce the risk of breaking the fixed part. If, for some reason, your 3D-printed part shows gaps between layers (under extrusion), you can use the 3D pen again to mask it. →

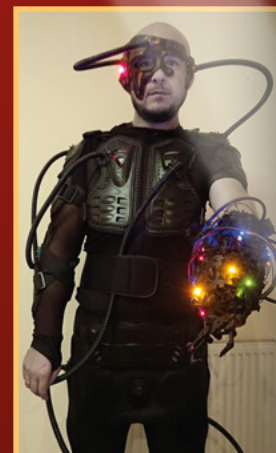

◆ Marcin is already working to make the costume more menacing by adding things like retractable assimilation tubules



VEHICLES, SPACECRAFT, AND ROBOTS

Come along for the ride

From *Street Hawk* to the DeLorean, sometimes a fictional vehicle manages to steal the limelight from the flesh-and-bone actors and become engraved in the audience's consciousness.

The Ecto-1 from *Ghostbusters* is one such vehicle, and Jerry Jodloski created one (hsmag.cc/Ecto-1) with the help (and hearse) of his friend Aaron Aikman. Jerry is the event director for a festival called How-To Halloween that he describes as "a Halloween-themed Maker Faire, which promotes and inspires people of all ages to build something spooktacular for the season."

Since building the Ecto-1, Jerry has helped create five more *Ghostbusters* vehicles for friends, and has a couple more to do in the pipeline

Jerry finds resonance with the *Ghostbusters* world, where he believes all of the interesting tech and spooky gadgets appear as if they've been hacked together: "Whether it's a Proton Pack or an Ecto-1, these props are a great starting place for the DIYers to attempt a build project of a movie replica. They're not perfect, and that's what makes them cool."

The roof-rack is the most complex part of this build. Jerry and Aaron found all the components from the surplus store of a local college, which they then first mocked up on an old bed-frame before bolting it on to the hearse. They then wired the lights, siren, and smoke machine along with a working air compressor on the roof. Jerry believes it's the little details that add the magic to the project.

SMALL IS BEAUTIFUL

Roger Garrett too was inspired by a show from the 1960s. A long-time fan of *Star Trek: The Original Series*, it was the Galileo restoration project that pushed him to recreate the iconic Galileo shuttlecraft from the show.

Roger was all set to build a full-size version of the craft, but wasn't allowed to by CBS Productions, which owns the franchise. So instead he handcrafted a rendition that is four feet long and lights up just like the real thing (hsmag.cc/ST-Galileo).

The replica of the Galileo spacecraft is built with 1/8" thick medium density fibreboard (MDF) that's cut with either a laser, a router, or by hand on a small tabletop jig-saw. The warp engines of the replica are made from



3" mailing tubes. To make it look more authentic, Roger makes use of RGB LEDs controlled by an Arduino Uno.

Adam Woodworth created a scale-sized replica of a popular vehicle as well, but with a twist. You can, in a sense, ride Adam's *Star Wars* Speeder Bike (hsmag.cc/SpeederBike).

As soon as Adam was introduced to multirotor racing, it immediately reminded the *Star Wars* fan of the speeder bike Endor chase scene from *Return of the Jedi*. It didn't take long for Adam to combine the two to build a quadcopter that looks exactly like a stormtrooper on an Imperial speeder bike.

Although it's been half a decade since Adam shared his project, it's still just as cool. Adam, who's studied aerospace engineering at MIT, carefully took apart an old 12" 1:6 scale Hasbro speeder bike toy. "The big challenge was to figure out how to lift the whole thing, without making it look like just a big quad rotor tacked on," he writes. It took some doing to model a quadcopter appropriate for the toy. He then went ahead and snuck an ultra-micro FPV camera into the stormtrooper's helmet to fly the contraption using a pair of Fat Shark Dominator video goggles.

COME OUT SWINGING

Brandon Cullum, on the other hand, takes a different approach to make a spacecraft fly through space. He built an X-wing fighter from *Star Wars* into a swing (hsmag.cc/XWingSwing) for his daughter.

A prolific maker, Brandon loves to combine functional pieces with tech and geekdom. However, through it all, his goal is to encourage people to get building without being afraid of breaking things. He runs the aptly named Make Or Break YouTube channel where he takes on new projects, usually for the first time, and ends up making mistakes: "I want to highlight those mistakes and how to fix them to anyone following along."

The *Star Wars*-themed swing is made mostly from plywood, though the nose is fabricated out of foam and the engines from PVC pipes. Brandon plans to eventually make one out of metal since he knew this



one wouldn't last in the elements for long: "Now it's on the ground looking more like the X-wing in a swamp at Dagobah than one flying at Yavin."

MAN'S BEST FRIEND

Angelo Casimiro decided to kick things up a notch with his life-size fully functional BB-8 droid (hsmag.cc/BB-8). An electronics and communication engineering student at the De La Salle University, Manila, it was only natural for Angelo to bring his droid to life with electronics.

Besides the Arduino Uno, and a handful of other electronics, the entire robot is built with common household items. What makes it even more easily reproducible is the fact that the build process is free from any of the specialised maker tools like milling machines, CNC routers, and 3D printers.

Angelo's BB-8 has a Bluetooth module that allows control via a generic Arduino BT remote control app. The majority of the build involves creating the body of the robot from a beach-ball and its head from a Styrofoam ball. The electronics are glued to an MDF board inside the robot's body, and four rollers salvaged from roll-on deodorants give it its iconic movement. □

◆ Angelo runs a BB-8 builders club on Facebook, where members bounce ideas and help each other make and improve the robot's design and build process

▣ Adam continues to give wings to both fictional and real flying craft. Stop by his YouTube channel for the build details

◆ Roger is the author of *The Complete Star Ship: A Simulation Project* from 1978. The book describes how the bridge of the U.S.S. Enterprise can be simulated using small interconnected computers



SUBSCRIBE TODAY FROM ONLY £5



SAVE UP TO 35%

Subscribe today and get:

- ▶ **FREE delivery**
Get it fast and for FREE
- ▶ **Exclusive offers**
Great gifts, offers, and discounts
- ▶ **Great savings**
Save up to 35% compared to stores

📍 **Subscribe online:** hsmag.cc/subscribe

SUBSCRIBE TODAY

Subscribe for 12 months

Rolling monthly subscription

£55 (UK)

£90 (USA)

▶ **Low monthly cost** (from £5)

£80 (EU)

£90 (Rest of World)

▶ **Cancel at any time**

Free Circuit Playground Express with 12-month upfront subscription only (no Circuit Playground Express with rolling monthly subscription)

▶ **Free delivery to your door**

▶ **Available worldwide**

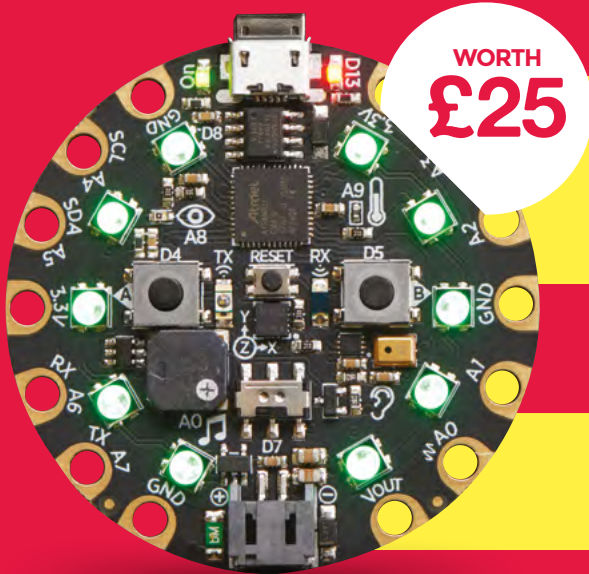

FREE!

Adafruit Circuit Playground Express

With your first 12-month print subscription

This is a limited offer. Not included with renewals. Offer subject to change or withdrawal at any time.

SUBSCRIBE on app stores

From **£2.29**



👉 Buy now: hsmag.cc/subscribe



HackSpace magazine meets...

Pete Wood

Who does Superman call when he needs a helping hand?

DesignSpark is a huge resource for design engineers, tech startups, engineering students, and makers. It's full of free software, designs, reviews,

blogs, and other resources to help engineers go further faster.

It's also a thriving community of over one million engineers, hobbyists, and makers. That's where Pete Wood comes in. He's in charge of everything front of house, whether that's sharing the latest product technologies from RS's suppliers and partners, or sending plastic toys into space. He's also been part of an elite group of engineers that have attempted to send an autonomous 3D-printed boat across the English Channel to France. Read on to find out how, why, and whether he succeeded. →



Above 

Pete's been part of the DesignSpark team at RS Components for the best part of 10 years



Right ⇨

The design of the boat changed over time as challenges were encountered and overcome

HS Hi Pete! Tell us about DesignSpark!

PW DesignSpark started just over eleven years ago. The day it turned one, I arrived on the door-step to start running the community. At that time we had 50,000 members, which is pretty impressive for a new community.

We started this community with a design tool called DesignSpark PCB, and a community where we would have a blogroll and we would connect with engineers. We're about helping design engineers go faster – we want to give them tools and resources to help them design things.

We're targeting professional design engineers. But we also have a big following of students, tech startups, makers, hobbyists, all of those sort of people. A lot of engineers are makers at heart as well, who are makers at night

and engineers during the day, so we've got fun stuff, we've got professional stuff, we've got a whole mixed bag of stuff.

We've also got a mechanical design tool called DesignSpark Mechanical that allows users to quickly design and change product concepts in 3D, without having to learn complex traditional CAD software. It's great for designing custom enclosures for your own PCBs or SBCs like Raspberry Pi. It outputs standard STL files so you can easily send your designs to a 3D printer, so it's great for rapid prototyping your projects, or just designing and 3D printing fun stuff! Our other tool is DesignSpark Electrical, which is a design tool for electrical installations.

Those are the tools – we also have a load of free resources. To enable design engineers to go faster, we share accurate 3D CAD models and PCB component

footprints. If you draw a model yourself, it takes hours, right? Or you can get them for free from us, it doesn't matter what PCB layout design tool or 3D CAD tool you're using, we have got CAD-neutral models and layout footprints for components, for semiconductor components, connectors, you name it. And it's not just models for DesignSpark tools; we have those for every single common format – Altium Designer, OrCAD, Mentor Graphics, etc.

Over the last few years, we've been proud to be able to have helped a number of tech startups who have utilised our free tools and resources, especially those who have been makers and then taken their ideas into a successful business – pi-top was one, the team who built the Raspberry Pi laptop; they started off using our free PCB and Mechanical design tool which enabled them to



Left ◀
With the batteries,
the boat weighs
around 50kg

create a working prototype that they used to promote the product and attract investors. Startups are a hugely important part of our industry, and we're here for companies like that who have come and used us and then moved on, which is fantastic, right – that's exactly what we're here to do. We're here to provide powerful tools that they can use with no commercial restriction, and then they go off and create successful businesses.

We're kind of a resource for technical content, and there's a design element as well. And then we do fun stuff as well, like putting a Superman action figure into space, which I did a couple of years ago.

HS Hang on, Superman? Tell us more about that.

PW Mattel came to us and said that they wanted to put a Superman figure into space, and could we help them do it? I live in Reading, and I just happen

to know some of the guys at Reading Hackspace. Through the DesignSpark community, I had also made friends with a guy called Jude Pullen, who was a design engineer at Dyson at the time. Jude is a talented engineer, card modelling guru, and Super Maker! Since then he's been on the BBC's *The*

”

We do fun stuff as well, like putting a Superman action figure into space

Big Life Fix, and he's done some stuff with David Jason on a show called *Great British Inventions*. Our first intro was back in 2012 when he created a DesignSpark article on how to create a Raspberry Pi case using everyday objects – it's amazing what this guy can

do with cardboard, cocktail sticks, and a Tic Tac container. Anyway, we needed someone to design a capsule to take the Superman action figure up into the edge of space, so I called him up and we went down to Reading Hackspace one weekend, and Jude modelled the whole thing in Correx.

We had two Raspberry Pis in there, a Raspberry Pi Camera, and we also had a tracking board on top of the Raspberry Pi which was from Dave Akerman, who has sent a few things into space, including a potato for British TV chef Heston Blumenthal. We put it all together with a weather balloon, and it was such an inspirational project. We took it to every event we did.

It's been everywhere; it's been around the world this thing. It was originally commissioned by Mattel Italy, so it's been on Italian TV. We took it to Maker Faires and schools all over the world, as well as trade shows like *electronica*; it got so much interest. ▶

”



Left  The testing involved dropping the boat from a height to see how it would cope with the waves of the English channel

Six years later, we realised that we should do something else, because it had garnered such interest. What can you do that's like Superman, but better than Superman, bigger than Superman? In the end, we started talking about doing something water-based. We then thought, why don't we try a world record at the same time? We got our brains together and came up with a 3D-printed boat. And then we wanted to make it autonomous, so we could program it up and send it on its way. The original had an action figure in it as well, as a sort of tribute to the Superman project. It was Zayn from One Direction with a beard on him. He's in my shed at the moment, in my workshop.

We worked initially down at the Reading Hackspace (rLab), but we quickly outgrew that place because they didn't have all the tools or the physical space we needed. Gary and Ryan, who

were working on the project at the time, were also working at the Imperial College London hackspace (Advanced Hackspace), and I'm based in London under normal circumstances, so we went there to use their facilities.

We also joined the model boat club at Beale Park, which is in Reading, to advise on certain things, and we used the lake for testing. In one of the videos you'll see me in the lake, we're chucking the boats around and doing self-righting tests.

So many people bent over backwards to help us including the Channel Swimming Association and a sea sports company at Dover. They were quite happy to help us out with what they know about currents and things, and let us use their route.

In the meantime, we were going backwards and forwards with the coastguard. I contacted the English coastguard, and they were like 'amazing

that sounds really great – but you need to speak to the French coastguard'. I was a bit, hmm, this doesn't sound like it's going to be very easy. I even had to complete an official form for 'unorthodox Channel crossings' to explain our project.

It turns out the French coastguard is controlled by the military, so they were quite challenging to deal with. And then I heard stories.

It appears that over the years there have been a few publicity stunts that involved crossing the Channel, including a well-known British TV show, that has potentially resulted in making it much harder to get permission. This, in effect, finally gave us a 'no' to our request for an 'unorthodox Channel crossing', and to add to that, the real nail in the coffin was that they copied in every coastguard down to the tip of Spain when they told us not to do it!



Right As this challenge was set by Mattel Italy, Superman speaks with an Italian accent

We started to investigate alternative crossing routes, like Wales to Ireland and Denmark to Sweden, but time was against us as it's a very seasonal project as well. You can only go on the sea at certain times of the year. If you go beyond September that's it, you're lost until the spring. We missed the window in the first year. It took us two years to get this project together with various difficulties, and then Covid-19 delayed us getting the videos out.

The actual project probably took us around seven or eight months part-time, and the rest of the time was waiting for the right weather conditions.

HS How did you get yourself into the huge military test tank that I've seen you playing in?

PW Richard Browning, the guy who has the rocket suit, I was at a flight with

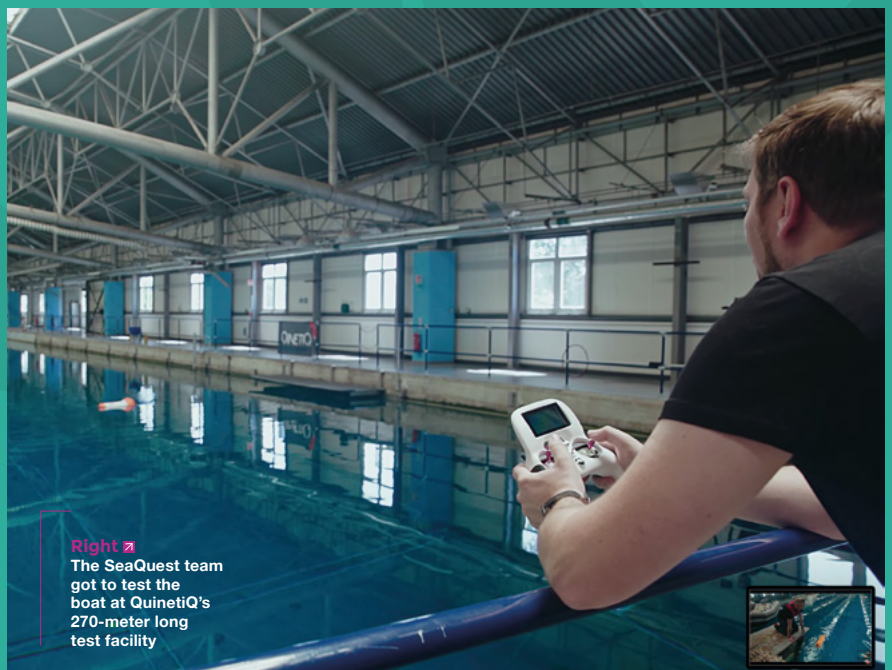

Right The SeaQuest team got to test the boat at QuinetiQ's 270-meter long test facility



Right  How much higher until we reach Krypton?

him, and there were a bunch of guys from a company called QinetiQ with him. I was telling him about the project, and they said 'you want to come and put your boat in our test tank. We've got the biggest test tank in the world!' I thought, that sounds good!

The next thing you know, we'd blagged our way into this test tank where they shoot *James Bond* films and test model submarines and stuff.

HS How big is the finished thing?

PW 1.3 metres long, I think. So it's not that big, but with the batteries in it are a fair old weight. I had never seen massive LiPo packs this big before – these cost £300 per pack, so we had about £700 worth of batteries in this thing, daisy-chained together. We started out with big, heavy lead-acid things which were actually quite good for ballast. When we

were down at Reading Bus Depot, which is where Alex keeps his 3D printer.

We were using an Ultimaker S5 as our main printer, so the size of the boat was restricted to the volume build of the printer (max width and height), so you could only go so wide and so tall. Alex built this full-size Rep Rap Ormerod printer in his workshop at the Reading Bus Depot, so we were able to build something a bit bigger in terms of volume, even though the resolution wasn't quite as good, but it was great for building the initial prototypes.

HS What was the world record you were going for?

PW We wanted to set a distance-based record. Originally it was the greatest distance travelled by a 3D-printed boat in 24 hours. Someone had already registered for this record, so we reasoned that it must already have been approved, so there was a record out



Left  The core members of the SeaQuest team are (l-r) Richard Ibbotson, Pete Wood, Gary Fletcher, and Alex Gibson



Right ↗
It's not all James Bond-style test facilities: the hull of the boat was printed at Reading Bus Depot and tested (by Zayn Malik) at Beale Park in Reading



there that we could beat. Then things got complicated.

After parting with some cash and finally getting some confirmation of the record parameters, it appeared the record we wanted to set wasn't going to float! Our desire to set a record for the greatest distance travelled by a 3D-printed model boat in 24 hours didn't fit the criteria, as everything in the boat had to be 3D-printed – which would have meant that we couldn't put an engine or any electronics in it. They also had question marks about the attempt being made on sea, because apparently, it made things too easy for us! Have you ever put anything on the sea? Putting a boat on a flat lake is simple; putting something in the sea where you've got currents, waves, and swells (and shipping lanes) is not simple, but they wouldn't have it.

Anyway, after various correspondence, the rules were set, giving us a distance-

based record to beat of 52 miles on *any* body of water

HS Did you break the record?

PW You'll have to watch episode ten to find out!

We're planning on sharing all the design files with anyone who wants to build their own. We were looking at doing a big challenge at some point – we've done it, now come and beat us, that sort of thing. We wanted to try to build a community spirit around that, to inspire people to go and build their own thing and do their own thing. That's what we want them to do, go off on their own to build something and set a record.

And everything we learnt is out in the open. We talk about the prototyping, the engineering challenges, how we got over those, how the design iterated, how we used 3D printing to make tweaks. We

started off with a double prop design and we ended up with a jetboat. It's really a story of prototyping and the evolution of the design, mixed in with a bit of boats catching fire, and three blokes messing about. ☑

Below ↓
Did they make it to France in the end? Watch and learn at rs-online.com/designspark/team-seaquest



THE OFFICIAL Raspberry Pi Beginner's Guide

The only guide you
need to get started
with Raspberry Pi

Inside:

- Learn how to set up your Raspberry Pi, install an operating system, and start using it
- Follow step-by-step guides to code your own animations and games, using both the Scratch 3 and Python languages
- Create amazing projects by connecting electronic components to Raspberry Pi's GPIO pins

Plus much, much more!

£10 with **FREE**
worldwide delivery

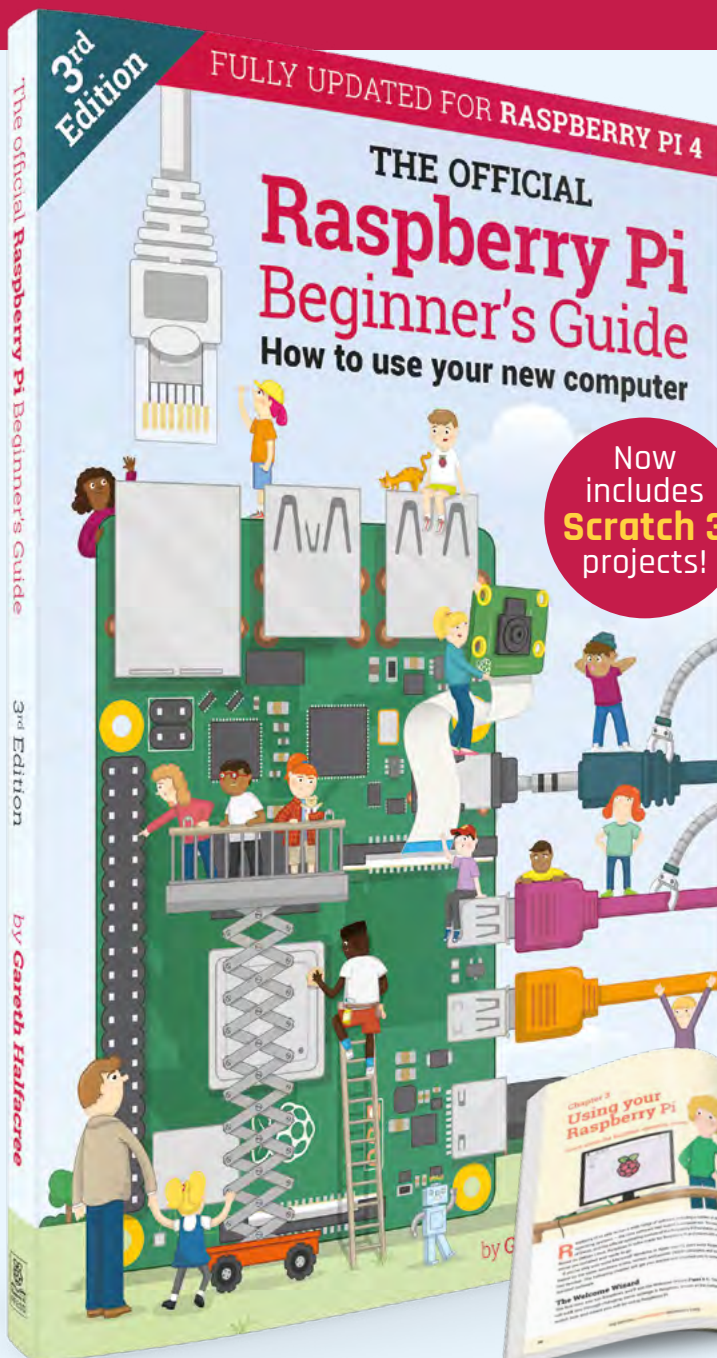

Buy online: magpi.cc/BGbook

BOOK OF MAKING

VOLUME 2



ONLY
£10

WHSmith
BARNES & NOBLE



THE BEST
PROJECTS FROM
**HACKSPACE
MAGAZINE**

THE ULTIMATE SKILLS,
TRICKS, AND MAKES

AVAILABLE NOW

hsmag.cc/store

FROM THE MAKERS OF **HackSpace** MAGAZINE



Unlock your creativity



Mayank Sharma

[@geekybodhi](#)

Mayank is a Padawan maker with an irrational fear of drills. He likes to replicate electronic builds, and gets a kick out of hacking everyday objects creatively.

W

e've been keeping our valuables under lock and key for virtually as long as we've had something to protect.

The oldest known lock, dug up by archaeologists, dates back to over 4000 years. It was uncovered in Mesopotamian ruins and predates the Egyptian pin lock. Crafted from wood, pin locks were first used by Egyptians. As was the norm back then, such novelties were only available to the affluent.

These early locks were quite cumbersome to operate. The locking technology advanced when the Romans switched to using steel springs to create pin tumbler locks. The Romans were also the first to use keys made from iron and bronze.

Locks and keys have been a characterising feature of virtually all civilisations, with all of them having been inventing new lock designs or improving existing ones.

Fast forward a few thousand years, and it was British inventor Robert Barron who, in 1778, invented the double-acting lever tumbler lock that's still in use in some parts of the world even today.

The next major innovation in lock design came with the first durable key-changeable combination lock created by James Sargent in 1857. Sixteen years

later, he designed the first time lock, following it up with the first time-delay combination lock in 1880. As you can imagine, Sargent's locks have had a profound impact on the personal safe and bank vault security sectors.

Locksmiths were quite in demand back in the day and thought of themselves as artists. Back then, they'd craft the lock by hand and customise them to suit the appliance they were installed upon.

The rise and popularity of the locks brought with it an increased interest from thieves who could pick them. The 19th century is filled with locksmiths trying to outdo each other to create more complex, secure locking mechanisms. The duels between locksmiths and inventors Jeremiah Chubb and Alfred Charles Hobbs are the hallmark of this time period.

If locks get all the attention from locksmiths and inventors, the keys fall squarely in the domain of the artisans. The ancient Chinese were perhaps the first ones to mould the keys in various shapes. Keys were originally made to be unique, until 1917 when the first technique of duplicating keys was invented.

These days, the three most common types of keys are house keys, car keys, and useless keys. If you're looking for ways to make those useless keys usable again, here are some interesting projects to get you started.

VW RING

Malcolm's owned a couple of Volkswagens since he bought the first one, a 1970 beetle, in his teens.

While working on a friend's camper, he suddenly realised that the old VW key in his hand would make for a great ring. He started by using a blow-torch to heat the key to make it more malleable. Malcolm suggests you heat the ring until it starts to change to a light pink colour. He found the key was a little too brittle when he tried to bend it while it was hot, so he first cooled it a little by dipping it in some water. To bend the key, he first clamped it to a pipe, before slowly hammering it around. Once it had hugged the pipe, he finished off with a few blows from a jeweller's hammer until it was smooth and flat. Malcolm says he had to heat the ring a couple of times during the hammering process to make sure it stayed malleable long enough to get the desired shape. Finally, he used some polish and the polishing attachment on a Dremel to give the ring a nice finish. The process took about an hour, and can be done with some effort without any of the tools that Malcolm's used. →

Project Maker
**MALCOLM
MCLEOD**

Project Link
hsmag.cc/VWkey

"HE FINISHED OFF WITH A FEW BLOWS FROM A JEWELLER'S HAMMER UNTIL IT WAS SMOOTH AND FLAT"



Right ♦ While Malcolm's used blank keys for the ring, he reckons cut ones would work just as well

STEAMPUNK PENDANT

Project Maker
GAYLE BIRD

Project Link
hsmag.cc/pendant

An online instructor and course developer in various design subjects, Gayle is a self-taught jewellery designer who makes unique wire-wrapped jewellery.

In the video, she takes us through the process of creating a steampunk pendant built around a key, which also happens to be one of her best-selling pieces of jewellery. She does two designs in the video. One is a painted frame that she combines with a key that has an interesting design, and the other is a plain frame with a painted key. Gayle uses a pair of angled needle-nose pliers, which seem to be the right tool for the task. She glues the bead to the centre of each key, and then uses a 22-gauge ParaWire in

a vintage bronze colour to design the swirls. She begins by doubling the wire and then creating a loop, which you can turn into a bail with ease, as she demonstrates towards the end. Also, while she creates the swirls, she very cleverly weaves the wire such that it secures the bottom half of the key to the frame. The real trick to designing the pendant isn't in the actual know-how, but rather having the dexterity to craft the intricate swirls, which Gayle does effortlessly.

"SHE BEGINS BY DOUBLING THE WIRE AND THEN CREATING A LOOP"



Right ♦ Gayle suggests you can use an old earring as the circular frame, and the key can either overlap it or be contained inside it

JEWELLERY HOLDER

Here's another project that involves bending keys, but it won't require as much effort as Malcolm's ring. YouTube DIYer Caitlin has used some old keys, a piece of driftwood, and a few screws to make herself a rustic necklace holder. She hooks the keys to a vice and then bends them with pliers. The keys won't put up much of a fight and, in fact, you can break them if you bend them too quickly. To avoid this, Caitlin suggests you "start to bend at the base of the key and slowly work your way up with needlenose pliers". When your key hooks are ready, find a piece of driftwood and drill holes five inches apart. Then pass the screws through the hole in the key and screw them to the wood. Finally, drill two holes into the back of the wood to help you mount it to a wall.



Project Maker
CAITLIN

Project Link
hsmag.cc/DIYCaitlin

Left ♦
When done with a smaller piece of wood, this makes for a wonderful key holder

WIND CHIME

Katrina loves wind chimes, so she decided to make one with keys. You'll need a wooden plate, string, and some keys sorted by size. Katrina first marks the holes in the plate before drilling them. She's used a spiral pattern, but if you have fewer keys, you can just do a circle pattern on the outside. Then thread the string from the bottom and tie a knot at the top. Then comes the tricky bit, where you have to figure out the length of the string. Make it long enough to accommodate as many keys as you have. Then tie your smallest key to the end. Repeat for the next hole. Cut this string slightly shorter than the previous string and tie on the next largest key, and repeat for the remaining holes. Finally, drill three holes to hang the wind chime and follow her lead to hang it securely. □



Project Maker
KATRINA

Project Link
hsmag.cc/keychime

Left ♦
This wind chime has some 40 keys, though you can easily adapt the design to make one with fewer keys

THE MAGPI



This article is from in The MagPi, the official Raspberry Pi magazine. Each issue includes a huge variety of projects, tutorials, tips and tricks to help you get the most out of your Raspberry Pi. Find out more at magpi.cc



Warning!
Mains Electricity

This project uses mains electricity with a voltage reducer. Be careful when working with mains electricity.

magpi.cc/electricalsafety

Holiday Projects for a Festive Home

Deck your halls with Raspberry Pi decorations and more this Christmas

The holiday season is upon us and we fancy going all out this year to turn our homes into winter wonderlands. With Raspberry Pi you can create incredible decorations with automation, lights, sound, remote control, and pretty much anything else you can think of! We've put together a selection of fantastic community projects to give you some inspiration for decorating your house inside and out. Let's get festive.



Outdoor decorations

Light up your street with pure seasonal cheer (and some LEDs)

Your house could look like this, with careful use of a ladder



Xmas lights for beginners

Sometimes you need to do something a little grand, especially for the holidays, and lighting up the outside of your house is one excellent way to do it. If you're not sure where to begin with this, then this guide by Makin'Things will not only get you set up with lights, but also shows how to get them to sync up with music.

It uses the excellent lightshowpi Python library (lightshowpi.org) to make the music syncing fairly easy. It also uses relays and a lot of power, so be extra careful if you plan to follow it!

magpi.cc/xmaslightsbeginners



2018 Christmas Light Show



▲ You might want to warn your power provider before switching these on

Are you really doing your outside lights correctly if you're not worrying your neighbours? If you really want to see how much you can do with lightshowpi and the kind of setup Makin'Things does, this light show which includes lawn ornaments, a tree, and 4000 lights should give you some inspiration.

It's all still controlled by music as well. Once again, you'll need to be extremely careful with heights and electricity use if you plan to recreate this.

magpi.cc/2018lightshow



▲ Different colours and arrangements can be achieved

LED display matrix

If you don't fancy doing the whole house, then maybe a window will do! Andrew Oakley shows you through how to create a set of animated LEDs for not too much money. It also takes PNG images, so you don't need to program each individual LED and it can even scroll text as well!

While relatively simple and cheap, you may have to do some woodworking, so get it started ahead of time and make sure to be careful when using any carpentry tools.

magpi.cc/ledmatrix



▲ The matrix is fully programmable to show images and scrolling text



▲ You may have your work cut out to get it ready

Power up your tree

Even with just a fake Christmas tree, you can really bring it to life with a Raspberry Pi



Smart Christmas tree lights

Not only are these Christmas lights made with fully programmable NeoPixels, giving you unlimited flexibility in colours and patterns, but they also add voice control so you don't even need to touch them! Sure, you could implement some remote SSH system, but this way is a bit more fun.

We made this in *The MagPi* last year and we think it still holds up! You may want to invest in a little 5V power supply adapter, as changing out batteries all the time does get a little boring.

magpi.cc/smartxmaslights

▲ You can use a bigger tree if you have enough NeoPixels



Star kit

Don't fancy printing out and rigging up your own customised tree star? The Pi Hut has you covered with this excellent star kit that just requires you to add a Raspberry Pi Zero and a bit of code – which you can hack and change yourself of course!

Find it here: magpi.cc/tpstar



▲ Always test your circuits

Tree Star

Another *The MagPi* original, this one uses a 3D-printed star to act as a tree topper, with some LEDs installed inside to light it up! It's been a few years since we selected this specific 3D star file from Thingiverse, so you might be able to find something better or whip one up yourself.

Make sure to scale the star for your tree, though – behind the scenes, this star wouldn't stay on the original tree we had and we needed a bigger one! If you're doing the smart tree lights as well, you can easily combine the two.

magpi.cc/xmasornament



▲ If you can find a translucent printing material, that will work best



▲ With the right 3D-printed parts, this can look very natural

DIY ornaments

Make your own Raspberry Pi-themed ornaments!

You can find many kinds of ornaments you can 3D-print on Thingiverse, and you can always make yourself one if you're handy with Blender. Raspberry Pi's own Alex Bate created these Raspberry Pi logo and Code Club logo baubles a few years back which you can print yourself! Have a look at them – and find the links to the files – here: magpi.cc/festivebaubles

YouTube Christmas Ornament



▲ It doesn't require many parts either

We all know someone who needs to see the Coca-Cola Christmas advert before Christmas starts for them. You may even be that person! Relive all your favourite Christmas adverts through this ingenious build that puts a tiny display on your tree to play them all.

You have to supply the videos yourself, though, so if you really want to embarrass someone, you'll need to digitise some old VHS tapes of Christmas past and upload them. Or just put your favourite Christmas films on there.

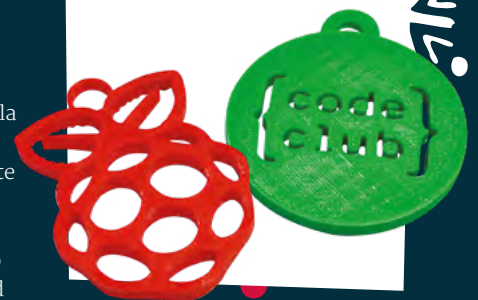

Deck the halls

Give the rest of your home a bit of seasonal magic



▼ The façade is pretty fun, although you could probably add fake logs if you really wanted

▲ It's just like having a real fireplace, albeit without Dick Van Dyke cleaning it

fireplace

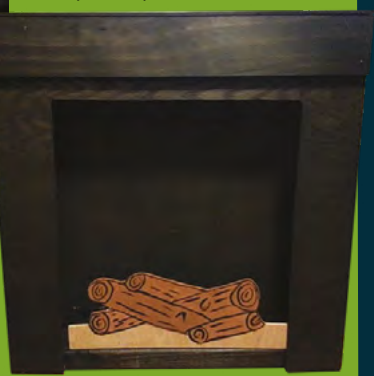

We must admit, we don't *quite* get the appeal of the fake fire on the TV during Christmas. This we can get behind, though – creating a fake fireplace and adding NeoPixels to create a warming fire effect that is sure to cozy up any room. It's even got a web interface you can control from your phone, allowing you to change the colours and turn it on and off. Very handy, and maybe a little spooky if you time it right to catch folks in the act of present-feeling.

magpi.cc/fireplace

▼ All the electronics are stored inside the house. Be careful using the 5V terminal!



▼ The light display is really very nice, with alternating colours on a slow cycle

Christmas house and snowman

This little diorama was created by Stewart Watkiss (aka PenguinTutor) to be part of an outdoor railway. However, it also functions as an indoor decoration. A string of LEDs on the front of the building act as some nice Christmas lights, and a snowman has NeoPixels inside so it can glow with awesome Christmas power.

The house and snowman were 3D-printed, although you could probably find some model kits that will allow you to do similar. We like the snow effect on the tray, and the little tree and people to give it the correct sense of scale.

magpi.cc/xmashouse



Smart gingerbread house

Gingerbread houses are a classic Christmas ornament for some families – one that probably wouldn't last to Christmas Day intact in our house. Estefannie decided to take it about two steps further, as she's wont to do, and fully automated a smart gingerbread house. It's also covered in enough sweets to attract Hansel and Gretel.

The whole thing also has a remote control function so you can switch the lights on and off, open and close the door, and a lot, lot more.

magpi.cc/gingerbread



▲ Just some of the parts you'll need for this build



▲ The door opens and closes, which is pretty excellent

Decoration kits

Grab these fun little kits for more decorations!

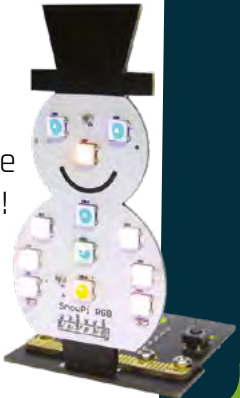

SNOWPI RGB

snowpi.xyz
price: £9

CHRISTMAS TREE SOLDER KIT

magpi.cc/treekit
price: £6



3D XMAS TREE

magpi.cc/3dxmastree
price: £15



Sense HAT advent calendar

▼ The version you'll make will let you know what day it is when you 'open' the door

Too impatient to wait until Christmas Day for your presents? Then how about a slow drip-feed of daily gifts like you'd get in an advent calendar? This digital version doesn't give you chocolates, unfortunately, but it is a neat and simple little project to help you get into the festive mood.

It's from the Raspberry Pi Projects website, so it's nice and easy to set up and requires very few components as well, relying more on code than anything else.

magpi.cc/senseadvent

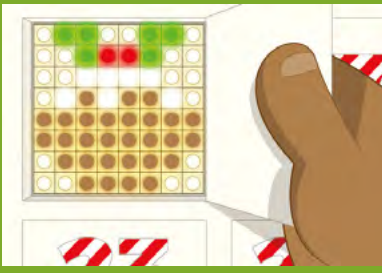



The
MagPi

HackSpace
TECHNOLOGY IN YOUR HANDS

CUSTOMPC

3 ISSUES FOR £10



FREE BOOK



hsmag.cc/hsbook

Subscribe to The MagPi, HackSpace magazine, or Custom PC. Your first three issues for £10, then our great value rolling subscription afterwards. Includes a free voucher for one of five fantastic books at store.rpiexpress.cc/collections/latest-bookazines
UK only. Free delivery on everything.

FORGE

HACK | MAKE | BUILD | CREATE

Improve your skills, learn something new, or just have fun tinkering – we hope you enjoy these hand-picked projects

PG
78



COLOURFUL LASER ETCHING

Create colourful images
using a laser cutter

PG
84

ESP32 DOORBELL



Extend the range of your doorbell
so that you never miss the postie

PG
88

3D DESIGN IN FREECAD

Creating custom parts
using sketches



PG
72

SCHOOL OF MAKING

Start your journey to craftsmanship
with these essential skills

- 72 I2C made easy
- 76 Face recognition

PG
94

TOUCH- SENSITIVE MUSIC

Turn almost anything
into a musical instrument

Qwiic, STEMMA QT, and Grove

Building your projects without soldering



Ben Everard

@ben_everard

Ben's house is slowly being taken over by 3D printers. He plans to solve this by printing an extension, once he gets enough printers.



I2C is a really useful protocol for connecting parts to your microcontroller.

It's well-supported by the majority of different microcontrollers and languages, it only uses two pins (plus power and ground), and you can connect many devices to a single I2C bus.

To make it even easier, some hardware manufacturers are putting push-fit connectors on their products, so you can build an electronics project by just slotting connectors into holes – no soldering necessary.

There are a set of competing standards that are almost, but not quite, the same. Sometimes they can be interchangeable, but not always. Let's take a look at the different options.

Grove, by Seeed Studio, was the first common standard for using this style of cable in I2C products. It uses a 2mm-spaced proprietary connector. All

Grove devices use the same 4-pin connector, but not all use I2C. Some devices require 3V, some 5V, and some can accept either, so you need to check that you're using the right peripheral with the right port on the right microcontroller to ensure it'll work.

STEMMA (by Adafruit) is physically slightly different to Grove, but it is close enough that it plugs in. Unlike Grove, all STEMMA 4-pin connectors are I2C. Microcontrollers may send 3V or 5V down the power line, but all STEMMA devices can accept either 3V or 5V, so any 4-pin STEMMA device should be I2C, and compatible with any 4-pin STEMMA microcontroller port.

STEMMA QT is, simply, STEMMA shrunk down to 1 mm-spaced pins. The QT version is compatible with STEMMA, but you need a conversion cable to click everything into place.

Above The finished air sensor, making sure our office air is keeping us healthy

Qwiic (by SparkFun) is probably the most popular of this style of connector. It's almost compatible with STEMMA QT, but there is a slight risk that STEMMA and STEMMA QT devices can power the I2C bus with 5V, while Qwiic devices explicitly expect 3V. In most cases, STEMMA and STEMMA QT processor boards will only send 3V down the power line, but double-check this before plugging Qwiic devices into STEMMA, STEMMA QT, or Grove parts, as you may end up with a tiny (but potentially expensive) firework display. This isn't a risk when using SparkFun Qwiic processor boards, as these all send 3V down the power line.

So, what does all this mean? With Grove, you always have to check what's compatible with what, as there are a few different things going on. If you use a Qwiic processor board, you can use any Qwiic or STEMMA QT peripheral without fear of damaging it. If you're using a STEMMA or STEMMA QT processor board, you can use any STEMMA (QT or otherwise) peripheral and just need to double-check that it's a 3V device if you want to work with Qwiic peripherals. For Adafruit devices, this information will be in the pinouts of the main guide.

This is all talking about hardware compatibility. In principle, as long as the hardware is compatible, you can use the device with your microcontroller. In practice, how difficult this is depends on whether you have software support. I2C is a binary protocol, so you have to send binary commands and you'll receive binary data. Knowing what commands to send and understanding the data that comes back can be a bit tricky. All the information you need should be on the datasheet. However, if you're not comfortable working at a low level, you'll have a much easier time

DAISY CHAINING

Most, but not all, I2C boards have two connectors, which means that you can daisy-chain them by plugging one into the next to connect a string of sensors using just one port on your processor board.

There are a couple of potential problems – see the boxes on addresses and pull-ups – but you usually only run into these if you want to connect a lot of devices together.

If you want to connect many devices to a single port, but they only have one connector on each device, you can use a multiport like this: sparkfun.com/products/16906.

if there is a library for the device for the language you're using on the microcontroller. For the most part, these libraries are specific to the hardware (such as the chip or sensor used), not the make and model of the breakout board you're using.

THEORY INTO PRACTICE

Let's take a look at what it means to pull all this together. We're testing out an Adafruit Metro ESP32-S2 microcontroller in the office this month, so we've used that as the microcontroller board as it has a 3V STEMMA QT connector. To this, we've plugged in a SparkFun Environmental Combo Qwiic board, and into this, we've daisy-chained an Adafruit 0.91-inch 128 x 32 pixel monochrome display.

We've programmed this in CircuitPython to output data to the OLED. →

Below  The STEMMA QT connector (left) is considerably smaller than the STEMMA connector (right)

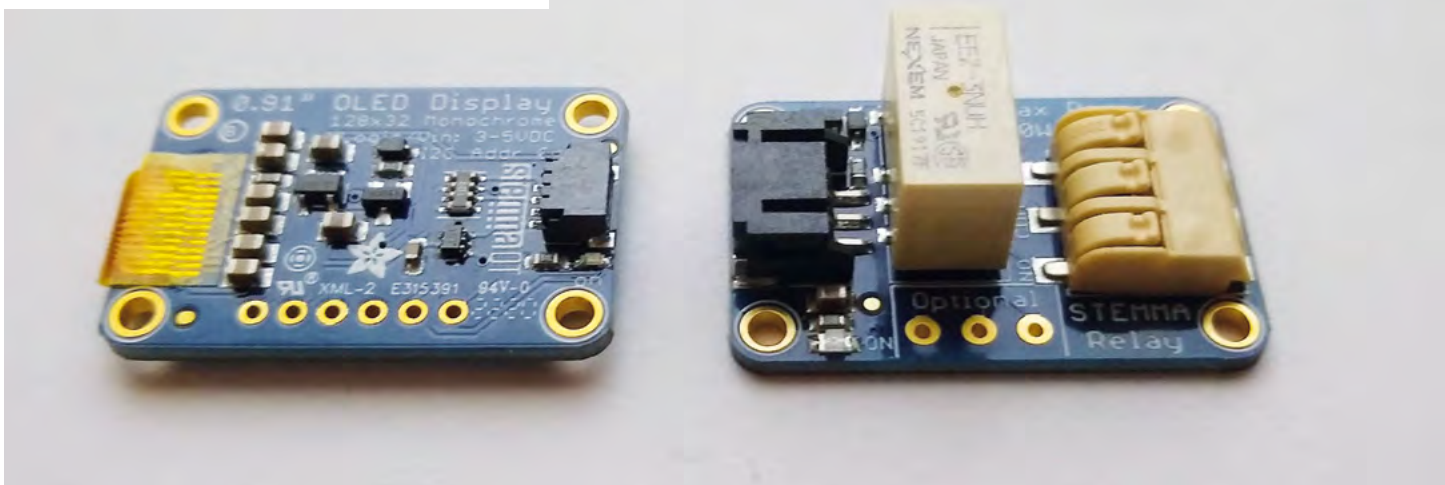

TUTORIAL

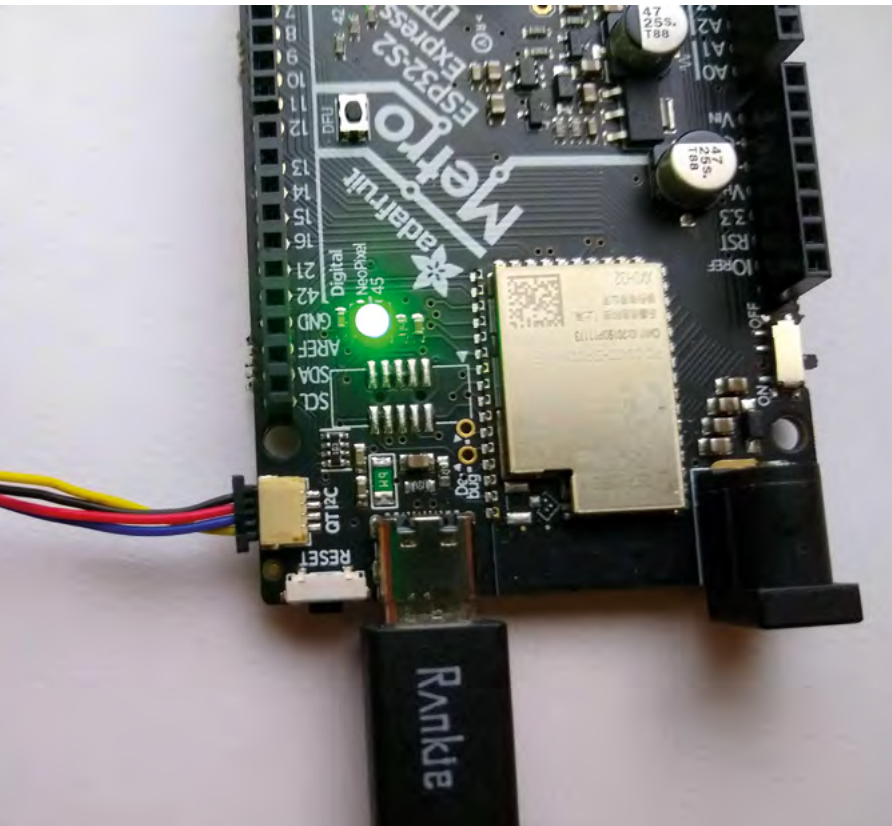

Above ♦ The STEMMA QT fits onto the side of the Metro board without blocking any of the Uno-compatible pins

```
import time
import board
import busio
import adafruit_ccs811
import adafruit_bme280
import displayio
import terminalio
from adafruit_display_text import label
import adafruit_displayio_ssd1306

displayio.release_displays()

i2c = board.I2C()

ccs811 = adafruit_ccs811.CCS811(i2c,
address=0x5b)
bme280 = adafruit_bme280.Adafruit_BME280_I2C(i2c,
address=0x77)
display_bus = displayio.I2CDisplay(i2c, device_
address=0x3C)
display = adafruit_displayio_ssd1306.
SSD1306(display_bus, width=128, height=32)

bme280.sea_level_pressure = 1033

#setup the display
splash = displayio.Group(max_size=10)
display.show(splash)
```

```
text = "init"
text_area = label.Label(terminalio.FONT,
text=text, color=0xFFFF00, x=2, y=4, max_
glyphs=50)
splash.append(text_area)

text_area2 = label.Label(terminalio.FONT,
text=text, color=0xFFFF00, x=75, y=4, max_
glyphs=50)
splash.append(text_area2)

while True:
    while not ccs811.data_ready:
        pass

    co2 = ccs811.eco2
    tvoc = ccs811.tvoc

    text = "Tmp: %0.1f" % bme280.temperature
    text = text + "\nHmd: %0.1f " % bme280.
humidity

    text2 = "CO2: %1.0f " % co2
    text2 = text2 + "\nTVOC: %1.0f " % tvoc

    text_area.text = text
    text_area2.text = text2

    time.sleep(30)
```

PULL-UP PROBLEMS

You can connect up to 127 devices to a single I2C bus. However, there are a couple of things to bear in mind. Firstly, I2C needs a pull-up resistor between the data line and power. Usually, devices come with these pull-ups already in place – great if you’re only connecting one device to your I2C bus. However, if you add multiple devices and they each have a pull-up, then you end up with multiple pull-up resistors in parallel, and this means that the total pull-up resistance will be lower than it should be. For many projects, you’ll probably only be connecting one or two devices to a bus, so you don’t need to worry about this. Exactly how many devices you can connect before it becomes an issue will depend on the value of the pull-up in each device. Fortunately, many Qwiic and STEMMA QT devices have cuttable traces on them that disconnect the pull-up. This is an exposed bit of copper on the circuit board that you can use a craft knife to break. Obviously, you don’t want to do this on all your devices, as you still need at least one pull-up on the bus. Should you then want to use a device with a cut trace on an I2C bus by itself, you can add a drop of solder to bridge the gap, and it will re-enable the pull-up.

WHAT'S THE ADDRESS?

The reason you can add lots of devices to an I2C bus is that each one has its own address. This is a 7-bit number that has to be unique on the bus. 7-bits means the number is between 0 and 127, but it's usually expressed in hexadecimal, so you'll see addresses with things like 0x5C.

Each device comes with its address preprogrammed in. So, for example, BME280 temperature and humidity sensors on the SparkFun Environmental Qwiic boards are at 0x77 by default. There's a cuttable trace that switches the address to 0x76. This means that, since there are only two options for the address, you can only add a maximum of two of these devices to an I2C bus. Not all devices have a cuttable trace, so sometimes you can only add one of a type to an I2C bus.

If you want to use more of a device than you have address options, you need to use separate I2C buses. In some cases, you'll have multiple ones exposed on a microcontroller. If not, you can use an I2C multiplexer which gives you multiple I2C buses accessible from a single I2C bus.

The ESP32-S2 Metro doesn't have enough flash space for the complete library pack, so you have to download the pack from circuitpython.org, unzip it, and copy just the ones needed to the **lib** folder on the CircuitPython USB device. In our case, these are:

- adafruit_bus_device
- adafruit_display_text
- adafruit_register
- adafruit_bme280.mpy
- adafruit_ccs811.mpy
- adafruit_displayio_ssd1306.mpy

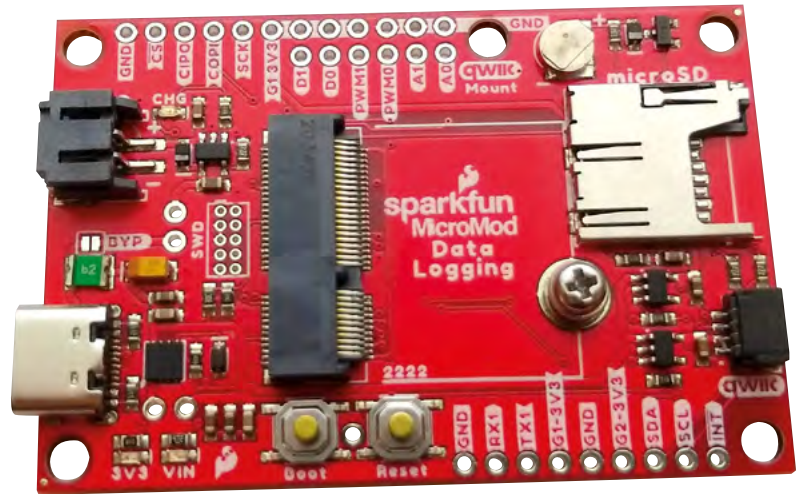

With those in place, the above code should run. You'll see 'init' appear twice on the OLED while the CCS811 sensor gets ready, then after a few seconds, you'll see readouts. It may take a little while for the values for CO₂ and TVOC (total volatile organic compounds) to stabilise.

You need to leave the CCS811 plugged in and running for 48 hours in order to stabilise (you may get some odd readings before this time is up). The point here, though, isn't really to set up this particular sensor, but to take a look at how quickly and easily you can combine sensors and displays from different manufacturers without soldering everything together.

There's a vast (and ever-increasing) range of Qwiic and STEMMA QT devices available – both processor boards and peripherals. The days when soldering is considered an essential maker skill could be limited. □

Above ♦ This MicroMod carrier board has an additional hole for mounting Qwiic boards

Below ▣ Many Qwiic boards – including this Environmental Combo – have two connectors to allow daisy-chaining peripherals

MOUNTING

The problem with building your project out of a range of small PCBs is making sure that they all stay where they should. After all, you don't want two PCBs coming together and their metal pads touching. Shorts like that could do anything from causing unexpected behaviour to damaging the parts.

Hot glue may work, but can be messy to take off if you need to, and it doesn't give your project the best look. Ideally, you should be able to mount your PCBs to some form of base. This could be as simple as a bit of wood that you screw into, or could be a custom-designed enclosure.

Many, but not all, small I2C devices have a mounting hole, so check before purchasing if it's important to you. Some SparkFun boards (such as the MicroMod Data Logging and ATP boards) have additional mounting holes specifically for the purposes of attaching Qwiic boards (labelled Qwiic Mount). These let you mount compatible Qwiic boards on a standoff on the mainboard.

The Qwiic mount system is a little inconsistently applied. For example, the MicroMod Data Logging carrier board has mounts for Qwiic sensors with holes on adjacent corners, while the MicroMod ATP carrier board is set up for sensors with mounting holes on opposite corners. You can mount any Qwiic sensor with mounting holes on either board, but in some cases, you'll only be able to use one screw which may be less secure.

While this is a little inconsistent, it does at least work some of the time. With other systems, there's no standard in mounting, so you're left to sort it out for yourself.

Add face recognition to your projects with Raspberry Pi

Buttons? Where's the fun in that? Why not trigger an event just by looking at a camera?



PJ Evans

@MrPJEvans

PJ Evans is a developer and wrangler of the Milton Keynes Raspberry Jam. He runs a LoRa gateway, which is probably the nearest he'll get to his own radio breakfast show.

It's hard to comprehend how far machine learning has come in the past few years.

You can now use a sub-£50 computer to reliably recognise someone's face with surprising accuracy. Although this kind of computing power is normally out of reach of microcontrollers, adding a Raspberry Pi computer to your project with the new High Quality Camera opens up a range of possibilities. From simple alerting applications ('Mum's arrived home!'), to dynamically adjusting settings based on the person

using the project, there's a lot of fun to be had. Here's a beginner's guide to getting face recognition up and running.

STEP ONE PREPARE YOUR RASPBERRY PI

For face recognition to work well, we're going to need some horsepower, so we recommend a minimum of Raspberry Pi 3B+, ideally a Raspberry Pi 4. The extra memory will make all the difference. To keep as much resource as possible available for our project, we've gone for a Raspberry Pi OS Lite installation

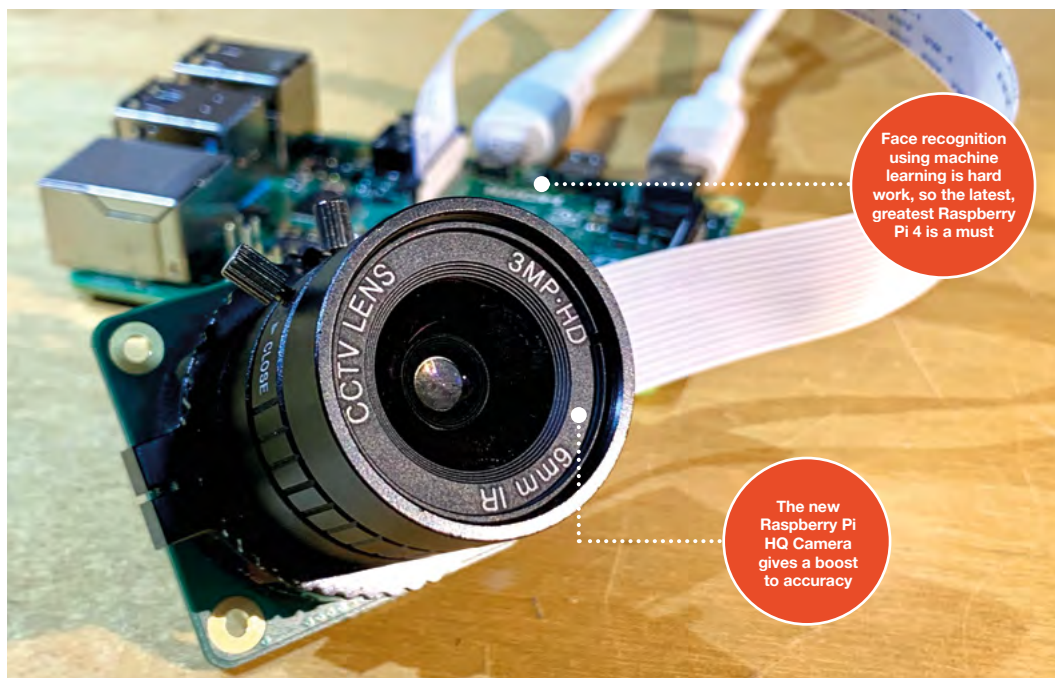

YOU'LL NEED

- ◆ **Raspberry Pi 4B**
hsmag.cc/RaspPi4
- ◆ **Raspberry Pi High Quality Camera**
hsmag.cc/RaspPiHQ

with no desktop. Make sure you're on the network, have set a new password, enabled SSH if you need to, and updated everything with `sudo apt -y update` && `sudo apt -y full-upgrade`. Finally, go into settings by running `sudo raspi-config` and enable the camera in 'Interfacing Options'.

STEP TWO ATTACH THE CAMERA

This project will work well with the original Raspberry Pi Camera, but the new official HQ Camera will give you much better results. Be sure to connect the camera to your Raspberry Pi 4 with the power off. Connect the ribbon cable as instructed in hsmag.cc/HQCameraGetStarted. Once installed, boot up your Raspberry Pi 4 and test the camera is working. From the command line, run the following:

```
raspivid -o test.h264 -t 10000
```

This will record ten seconds of video to your microSD card. If you have an HDMI cable plugged in, you'll see what the camera can see in real-time. Take some time to make sure the focus is correct before proceeding.

STEP THREE INSTALL DEPENDENCIES

The facial recognition library we are using is one that has been maintained for many years by Adam Geitgey (github.com/ageitgey/face_recognition).

//

These libraries can also identify 'generic' faces, meaning it can detect whether a person is there or not

//

It contains many examples, including Python 3 bindings to make it really simple to build your own facial recognition applications. What is not so easy is the number of dependencies that need to be installed first. There are way too many to list here, and you probably won't want to type them out, so head over to hsmag.cc/FacialRec so that you can cut and paste the commands. This step will take a while to complete on a Raspberry Pi 4, and significantly longer on a Model 3 or earlier.

STEP FOUR INSTALL THE LIBRARIES

Now that we have everything in place, we can install Adam's applications and Python bindings with a simple, single command:

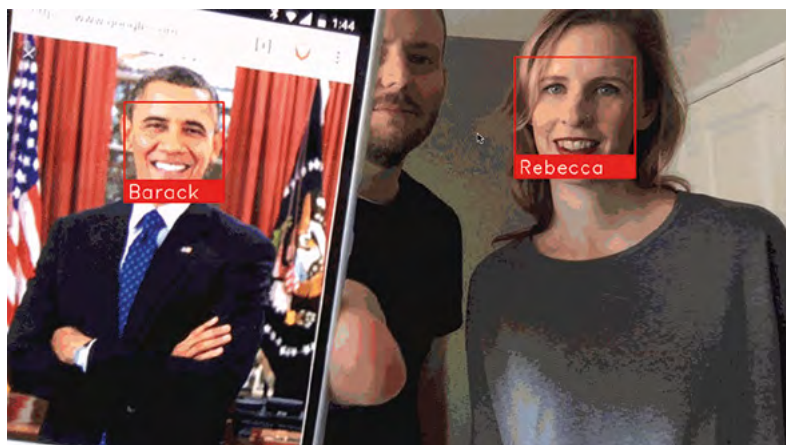

```
sudo pip3 install face_recognition
```

Once installed, there are some examples we can download to try everything out.

```
cd
git clone --single-branch https://github.com/ageitgey/face_recognition.git
```

In this repository is a range of examples showing the different ways the software can be used, including live video recognition. Feel free to explore and remix.

STEP FIVE EXAMPLE IMAGES

The examples come with a training image of Barack Obama. To run the example:

```
cd ./face_recognition/examples
python3 facerec_on_raspberry_pi.py
```

On your smartphone, find an image of Obama using your favourite search engine and point it at the camera. Providing focus and light are good you will see:

"I see someone named Barack Obama!"

If you see a message saying it can't recognise the face, then try a different image or try to improve the lighting if you can. Also, check the focus for the camera and make sure the distance between the image and camera is correct.

STEP SIX TRAINING TIME

The final step is to start recognising your own faces. Create a directory and, in it, place some good-quality passport-style photos of yourself or those you want to recognise. You can then edit the `facerec_on_raspberry_pi.py` script to use those files instead. You've now got a robust prototype of face recognition. This is just the beginning. These libraries can also identify 'generic' faces, meaning it can detect whether a person is there or not, and identify features such as the eyes, nose, and mouth. There's a world of possibilities available, starting with these simple scripts. Have fun. □

Above ♦
Who are you? What even is a name? Can a computer decide your identity?

QUICK TIP

Don't worry if you don't have a Raspberry Pi High Quality Camera – you can use the original or any compatible USB camera.

CODE

hsmag.cc/GitHubFR

Multicolour etch shop

Create multicolour art with your laser cutter



Dr. Andrew Lewis

Dr. Andrew Lewis is a specialist fabricator and maker, and is the owner of the Andrew Lewis Workshop.

Etching paint layers is one of the more experimental etching techniques that you can use your laser cutter for. It requires some experimentation and practice to get right, but the end result is worth the effort.

The principle behind colour laser etching is very simple. The idea is to tune your laser so that only a single layer of paint gets etched away, revealing the layer below. Repeat this for multiple layers, and you can create multicolour images. For one or two colours this is easy enough to keep track of,

but things get more complicated as you add more colours. While the principle is simple, the practice is more complicated and time-consuming. The amount of time required to prepare and etch your design increases with every colour you add. If you are working with a four-colour tile design, each painted colour layer will take at least four hours to prepare. Assuming that the base colour of your tile is one of the colours, that will mean twelve hours of waiting before you can start etching.

Begin by choosing a design and a set of colours that you want to work with. The more complex the



Right ♦ This etching technique relies more on practice than specialist materials, so be prepared to do some experimentation and learn as you go

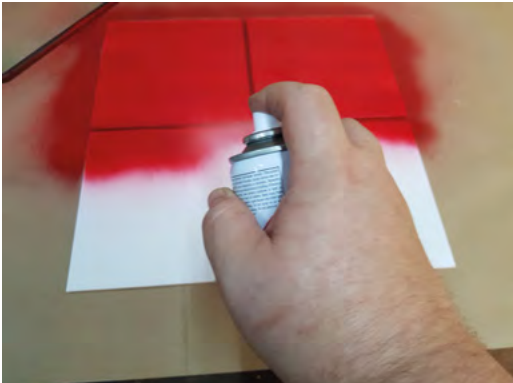

Above ◆◆◆

This technique works better if you apply thicker layers of paint than normal. Keeping the tiles flat and being in a warm environment will help prevent any sagging. It's important to remember that paint fumes are dangerous, and that particles of paint can be airborne for much longer than you expect them to be. Use a well-ventilated area, and wear a mask to avoid inhaling both fumes and particles of paint

design, the more finely-tuned you are going to need your laser power, speed, and focus to be. The rest of this article assumes that you will be working with the 'Ready Player 1' design, using red, green, black, and white. Look at your design, and consider the order that the colours should be. You will be layering several different colours of paint on top of one another, and you want to be removing the least amount of paint possible from each of the layers. The colour that is most prevalent should be the last coat that you apply, and the least prevalent colour

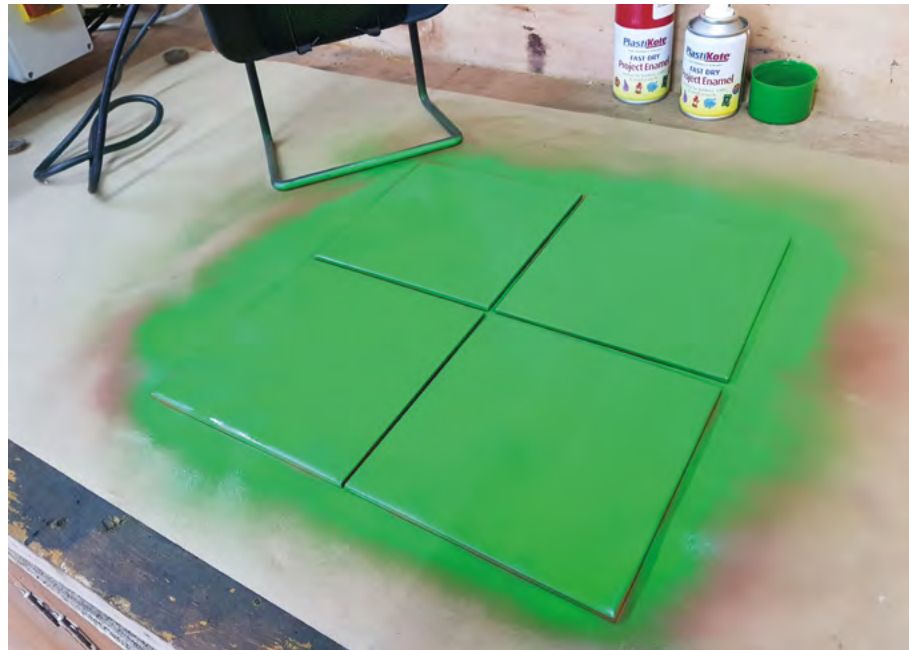

should be the colour of the tile itself. On the 'Ready Player 1' design, white is the least used colour, followed by red, then green, and finally black. The design is made up of three different vector files (green, red, and white), with each file corresponding to a layer of paint colour. There isn't a vector file for the black layer, because this is your default colour. If you don't do anything with the painted tile, it will still be black.

The way the design files are created is important to the final effect. For each design layer, it is fairly obvious that you need your laser to engrave the areas that match that paint colour. It's less obvious that you also need the laser to engrave the features

YOU'LL NEED

- ◆ **Quick-dry enamel spray paint**
(at least two colours)
- ◆ **Ceramic tiles**
150 mm x 150 mm

LAYERED DESIGNS

If you're making your own design, it's easiest to keep track of different colours by creating layers in Inkscape. Each Inkscape layer represents a different colour, and you can order the layers to match the order of the paint layers you'll be using. That means it's just a simple matter of turning layers on or off to create the colour separations for the laser.

“ The amount of time required to prepare and etch your design increases with every colour you add ”

in the layers of paint below the current layer. For example, if your paint layers are applied in the order black > green > red > white, and you want to etch a red circle, then the circle will need to be etched in green first, then red. If you want a white circle, you'd need to include the circle in the green, red, and white design layers.

Keep the 'Ready Player 1' design and colour layers in mind, and take some white ceramic tiles. Clean them all thoroughly to remove any grease and →

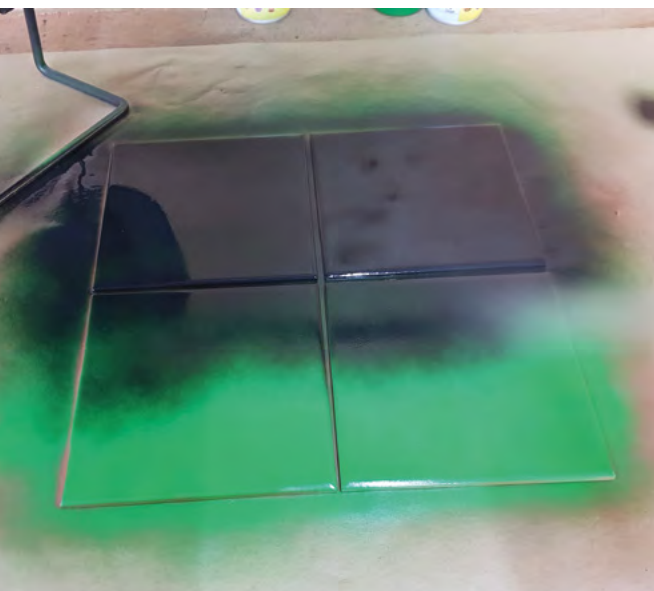

TUTORIAL



Right ♦

Remember that the laser you're etching with is invisible to the naked eye, and can be reflected off surfaces in unexpected ways. Never run the laser with the build chamber open, and always turn off laser power before opening the chamber door – even if you have door interlocks fitted

Below ♦

Once you have a good feel for the numbers that work on your laser cutter, you can skip the full calibration process, and adjust things on the fly for your first print

dust. Wiping them down with alcohol and a lint-free cloth should be enough for brand new tiles. Now take the red enamel paint, lay the tiles flat with a slight gap between them, and spray an even layer. Contrary to most painting practice and the advice on the side of the paint tin, thicker layers work better for this process. The thicker the paint, the more wiggle room you'll have when it comes to tuning your laser to etch the paint away. Leave the paint for

an hour, and then apply a second coat. Next, leave the paint to dry for at least three hours, or preferably overnight. The extra drying time improves the quality of the finished tile. Repeat this process with the green and black paint, applying two heavy layers of each and leaving appropriate drying time between each layer.

Place one of the tiles into the laser engraver, and get ready to start doing some calibration. Create a black rectangle in Inkscape, 1 cm wide and 10 cm long. Load this into K40 Whisperer, set your laser to low power, and start etching. The exact settings needed to get through a single paint layer will vary depending on the properties of the laser and optics, the thickness of the paint layer, and the properties

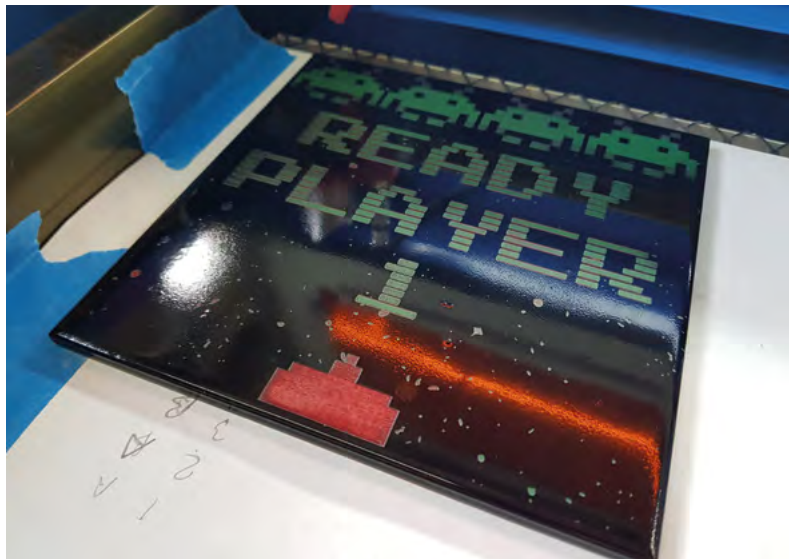

KEEPING IN LINE

Aligning your tile on the laser cutter might be a bit of a challenge if you're not used to it. A good tip is to tape a piece of paper to the bed of the machine and use the 'trace design boundary' tool with the laser active to lightly mark the paper. If you're going to be doing a larger number of tiles, it's worth creating a jig using a piece of plywood. Use a dab of hot glue to fix the plywood in place and laser cut a square the same size as a tile. Adding a semi-circular feature to one side of the cut-out will make it easier to remove the tile when you're done.



of the paint. Between 5% and 10% of full power at 200 mm/s is a good place to start.

When you reach 5% of the etching process, pause K40 Whisperer, turn off power to the laser, and open the lid to examine the tile to see how the etch is progressing. Close the lid, increase or decrease the

“ **Once your tile is finished, you can give it a protective coat of beeswax or lacquer, or leave it as it is** ”

power as needed, and then resume the print. After another 5%, stop and repeat the process until you are getting a consistent colour. As you start to dial in the settings, you’ll find that even 0.1% change can make a noticeable difference to the quality of the finish.

Slide the tile along and repeat the etch in an unused area with your best settings, so you have a complete bar of the first colour. Now leave the tile in this position, and start the whole process again to calibrate the settings for the second colour. You’ll end up with a set of numbers to fine-tune each



layer when printing to get the best results. Variation between the layers is to be expected, and typical numbers might be green 9.4%, red 9.8%, and white 10.8%, all at 200 mm/s.

Once your tile is finished, you can give it a protective coat of beeswax or lacquer, or leave it as it is. Just be sure not to use a coating that will react badly with the existing paint. Solvent-based paints and water-based varnishes don’t play well together, so be careful what finishes you choose to apply. If you want to experiment further, consider using this technique on other base materials. You can use aluminium or clear glass to get interesting reflective or translucent effects, or even use the effect in combination with wood engraving. ▣

SPECIAL EFFECTS

You can add accents to the tile by painting with a brush or scratching through layers with a sharp pick. You can also engrave through the glaze on the tile, and use a Sharpie or paint pen to soak colour into the porous surface for a different effect.

QUICK TIP

You should expect that there will be some failures while you dial in the laser settings. It’s worth preparing extra tiles just in case you have problems.

Above ♦ One or two colour etchings can be quite striking to look at, and there’s no harm in embellishing your prints with a felt-tip or paint pen if you decide to change things later



THE Official RASPBERRY PI HANDBOOK 2021



Radio Globe



Magic Mirror



Reachy Robot



Hot Spotter Drone



High Quality Camera



LED Mirror



Dual-screen InstaClock



Introducing RASPBERRY PI 400

Make amazing things with Raspberry Pi

FROM THE MAKERS OF *The MagPi* THE OFFICIAL RASPBERRY PI MAGAZINE

THE OFFICIAL RASPBERRY PI HANDBOOK 2021

Author: *various* Illustrations: *various* Photography: *various*

THE *Official*

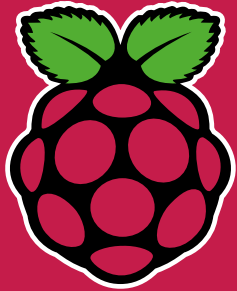

RASPBERRY PI HANDBOOK

2021



200 PAGES OF RASPBERRY PI

- Get started with Raspberry Pi, electronics, and more
- Be inspired by incredible projects made by other people
- Learn how to code and make with our step-by-step tutorials
- Find out about the top kits and accessories for your projects

Buy online: magpi.cc/store

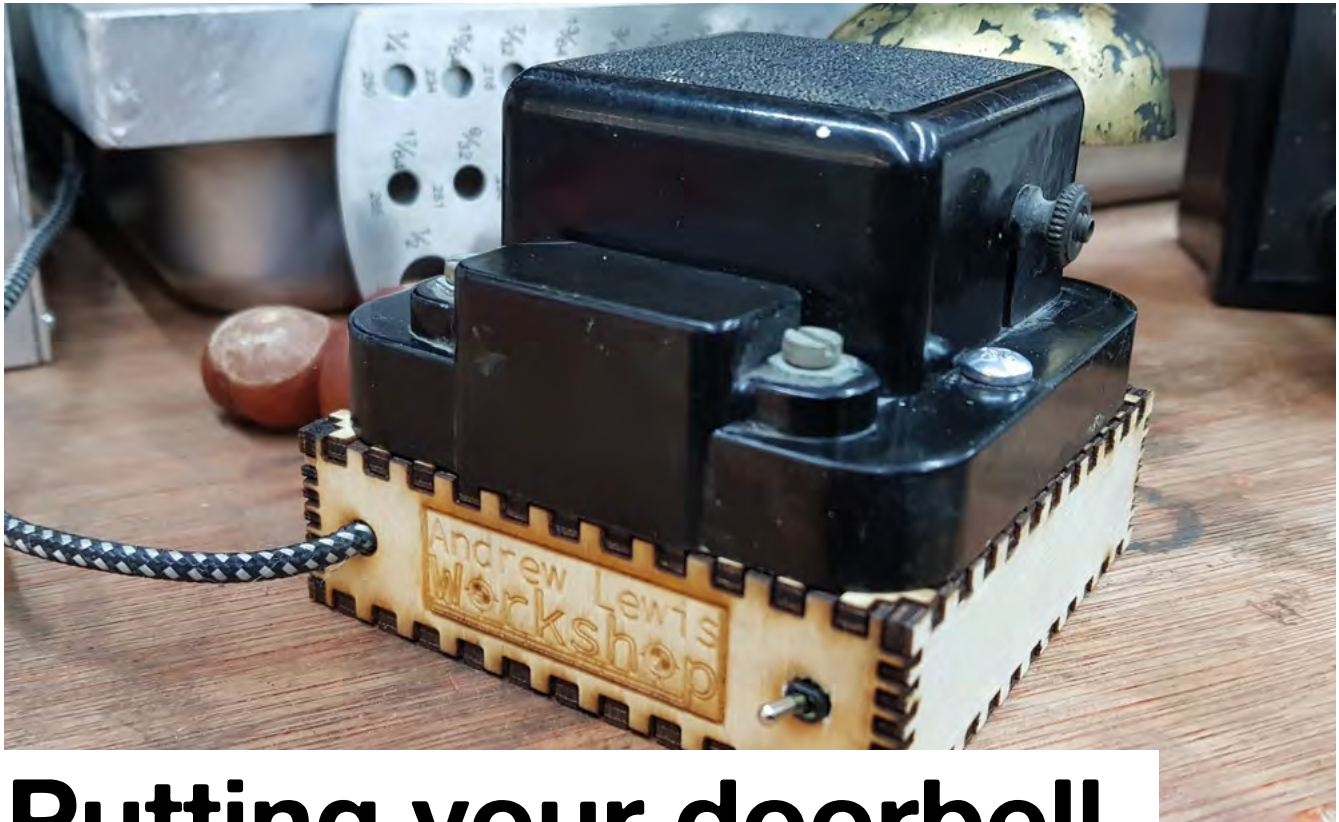

Putting your doorbell on the internet

Retrofit your AC doorbell with ESP32 and make it ring wherever you are



Dr Andrew Lewis

[@monkeysailor](#)

Dr Andrew Lewis is a specialist fabricator and maker, and is the owner of the Andrew Lewis Workshop.

In this project you'll use a NodeMCU to build a network-controlled ringer that's powered by USB, and a transmitter that fits inside an AC doorbell. Both of the

NodeMCUs share the same code, can function as an access point, and store all of their network settings in EEPROM, so they can be set up on the network without needing to modify the source code over USB.

DING DONG MERRILY ON WIFI

Missing a delivery can be frustrating, particularly if you were actually in the house but couldn't hear the doorbell from the room you were in. You could solve the problem with a simple wireless doorbell, but then you'd need to replace the existing bell and remember to change the batteries regularly. A better (and more fun) solution is to hack your existing mains-powered doorbell, and use it to send a signal via WiFi when the doorbell rings.

You will be building two circuits based around NodeMCU, and some explanation of the two circuits is necessary before you begin soldering things together. The first NodeMCU (the ringer) sounds an electronic bell when it receives a ring instruction over the WiFi network. The second NodeMCU (the door monitor) sits inside the existing bell box, and sends the ring instruction over the WiFi network when it detects that the doorbell has been pressed. The ringer takes power from a 5V USB plug, and is simple to build and understand. PIN_RINGBELL goes HIGH for one second when the ring instruction is received, triggering a transistor connected to a 5V bell or buzzer. Depending on the bell that you connect, it might be necessary to add a diode between the 5V and GND of the bell to prevent EMF backwash from causing a problem with your circuit. Look at the circuit diagram for the ringer (overleaf) to see how this is connected.

The door monitor has some extra circuitry because a wired doorbell uses unregulated AC (alternating

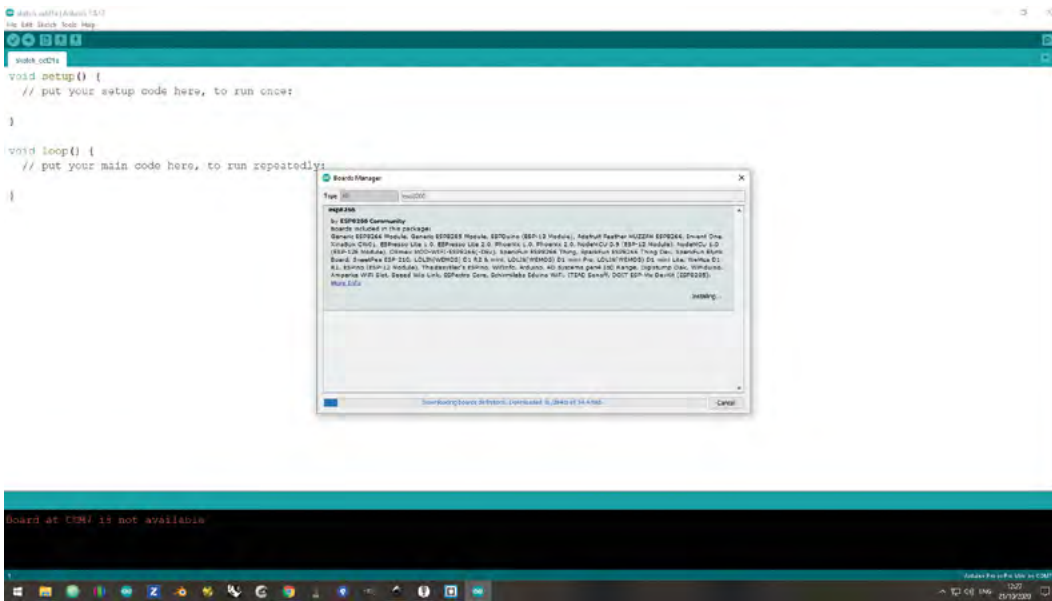

Left ♦ Support for the NodeMCU isn't installed in the Arduino development environment by default. To install it, you need to go into Preferences, enter `arduino.esp8266.com/stable/package_esp8266com_index.json` into the 'additional board manager URLs' field, and then click OK. Next, go into the Tools menu, and under Board, select the Boards Manager. Search for and install `esp8266` by `esp8266 community`. You should now be able to return to the Tools menu and select NodeMCU as the board type

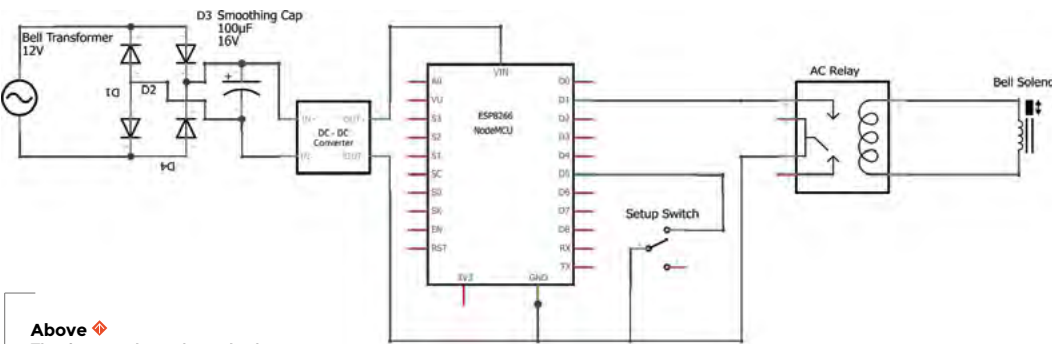

Above ♦ The door monitor schematic shows how the AC power from the transformer is converted to regulated DC. The value of the capacitor isn't critical, but larger values will help protect the board from crashing if the solenoid pulls the power too low

- YOU'LL NEED**
- ♦ 2 x NodeMCU
 - ♦ 2N2222 (or similar) transistor
 - ♦ DC-DC buck converter
 - ♦ 5 x 1N4001 (or similar) diode
 - ♦ 16 V 1000 µF capacitor (value isn't critical, higher or lower will probably be fine)
 - ♦ 5 V or 12 V AC relay (depending on transformer voltage)
 - ♦ 5 V buzzer or bell
 - ♦ USB cable

NUMBERING CONFUSION

Pin numbering on the NodeMCU is not straightforward, because the GPIO pin numbers in the Arduino development environment do not correspond to the pin numbers on the digital pins of the NodeMCU. The doorbell code uses pins D1, D2, and D5 on the NodeMCU, which corresponds to GPIO pins 5, 4, and 14 in the Arduino development environment. In addition to this confusion, some pins have system-specific functions associated with them and cause strange behaviour if they are pulled low at boot time. Pins D3 and D4 are two of these pins. If pin D3 or D4 are pulled LOW at startup, the board will not boot normally. An early version of this project used pin D3 for `PIN_SETUP`, but that has been changed to pin D5 for an easier setup experience.

current) electricity, while the NodeMCU uses DC (direct current) electricity, and needs a smooth supply in order to operate reliably. To adapt the AC to DC, you will use an arrangement of diodes called a full-wave rectifier (or diode bridge, or bridge rectifier). The rectifier takes the unregulated AC and converts it to unregulated DC, which is then smoothed with a capacitor and passed into a buck converter (also called a step-down converter) to regulate the voltage before it gets to the NodeMCU. An AC relay is wired across the solenoid in the bell box, so that the relay triggers when the solenoid is powered and pulls `PIN_RINGBTN` to LOW. The LOW value on `PIN_RINGBTN` causes the ring instruction to be sent over WiFi. Follow the circuit diagram for the door monitor (above) to see how everything fits together.

THE ONE RING

The best method for fitting the NodeMCU into the bell box will vary between doorbells, but most bell →

QUICK TIP
Use your router to set a static IP for the ringer and door monitor, to avoid your IP address changing unexpectedly.

Putting your doorbell on the internet

TUTORIAL

Right

You don't need a separate circuit board to mount the components for the door monitor. It's easy to fit all of the components onto the pins of the NodeMCU 'dead bug' style. This means that the door monitor is small enough to fit inside the battery compartment of most bell boxes

Below

The ringer circuit is quite simple. The optional backwash diode is only needed if the buzzer you're using has a coil that could generate a reverse voltage when it's turned off. This might be the case if you're using a vintage doorbell or extension phone ringer. The reverse voltage spike could cause instability in the NodeMCU, and can even burn out the transistor that controls the coil

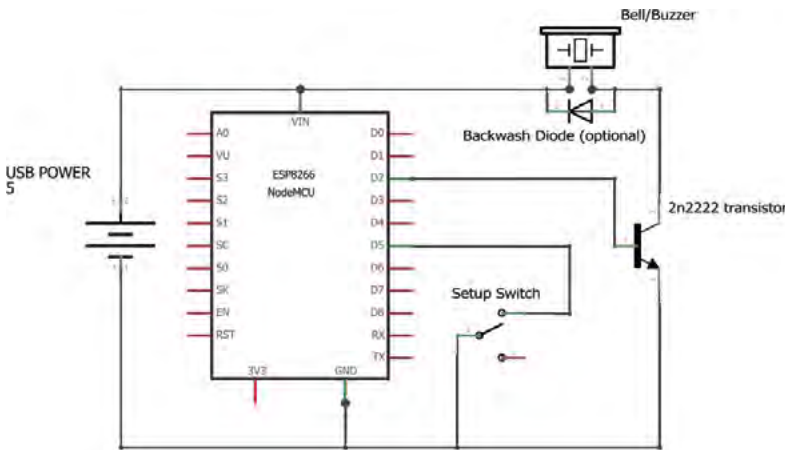
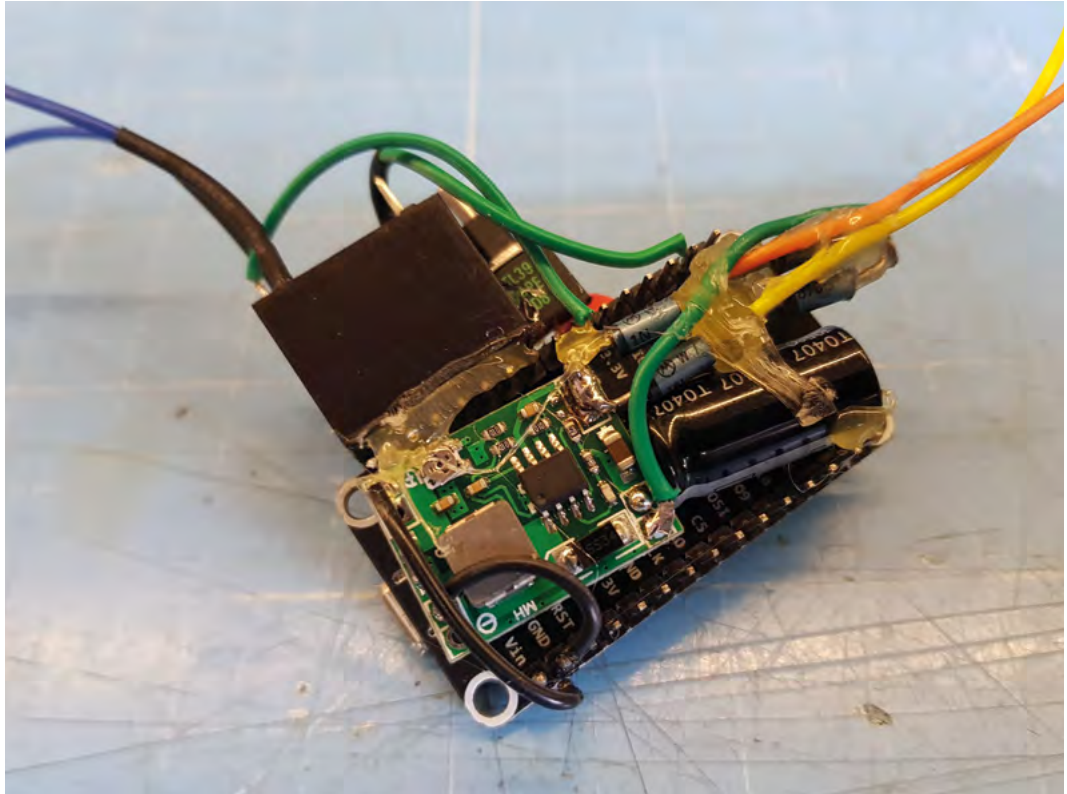

boxes have plenty of room inside. It's wise to fix your NodeMCU towards the bottom of the box, beneath any other electronic devices, so that it can't fall onto the solenoid or electrical terminals and cause a short circuit. Wrapping any exposed electrical contacts is also strongly advised. In some cases, a strip of double-sided foam tape will be enough to hold the board in place, while other boxes might need a cable tie to keep everything safely restrained when the solenoid moves.

It's wise to fix your NodeMCU towards the bottom of the box, beneath any other electronic devices

QUICK TIP

Some online resources claim that the NodeMCU can handle 20 volts on its Vin pin. This is wrong, and will result in a tiny firework display with blue smoke.

SAFETY

Mains-powered doorbells typically use a sealed transformer and run between 5 and 12 volts AC. All of the modifications in this project happen on the low voltage side of the transformer, inside the bell box. There is no need to go anywhere near to the 240V side of the transformer for any reason. Always double-check the output voltage to the pins with a multimeter before you touch anything, and turn off the power before you make any modifications.

Only undertake this project if you understand this, and the internals of your doorbell, and are confident that you can complete the project safely. If in doubt, ask for guidance from a suitably experienced person.

The ringer and the door monitor both have a toggle switch connected to PIN_SETUP. When this pin is pulled LOW, the NodeMCU will boot up into setup mode. While in setup mode, the NodeMCU will act as a wireless access point. It appears as 'WifiDoor' in the list of available networks, and the password is 'dingdong'. If you connect to this network, you can access the setup page at 192.168.4.1. You can use the setup page to enter

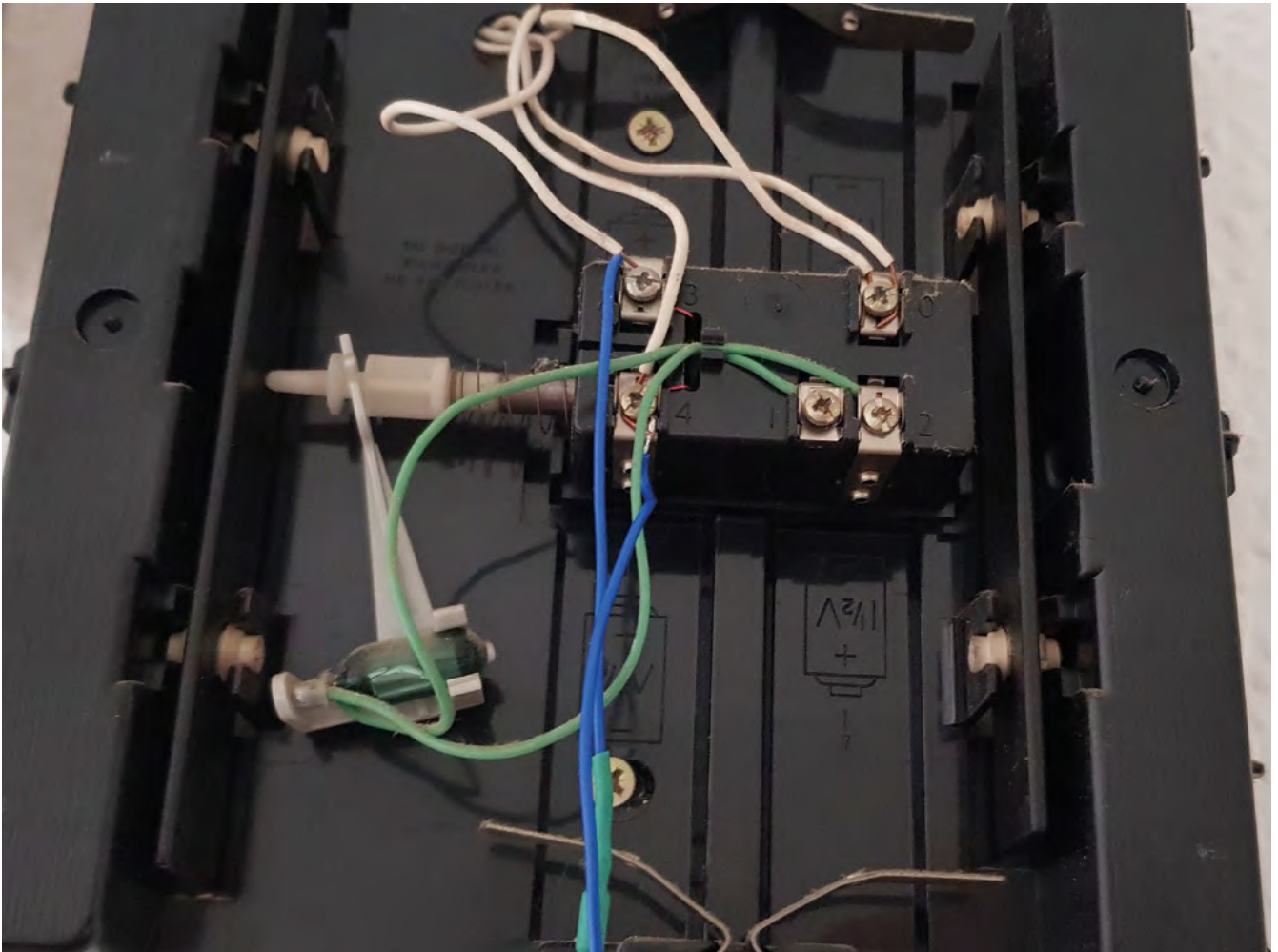

the SSID and password for your own wireless network, and also enter the URL that you want to send your ring instructions to. This URL only applies to the door monitor, as the ringer doesn't send any instructions. For the door monitor, you should set the URL to match the IP address of the ringer, and add '/ring' to the end of the address. So, if your ringer's IP address is 192.168.1.88, then you should enter '192.168.1.88/ring' as the address. You can test the URL in your web browser – navigating to the address should make the ringer sound the bell. You could also enter a different URL and use the doorbell to trigger a different device or service, such as an external webhook that posts a message to your phone.

If you're feeling adventurous, you could add in extra handlers to the ringer to deal with different types of instructions from different devices. You might choose to add a shorter ring to indicate an incoming email. You could also use another NodeMCU to monitor a different door or detect mail coming through the letterbox. □

DOWNLOAD THE CODE

➔ hsmag.cc/issue38

REVERSE-ENGINEERING

It's surprising how complicated something as ubiquitous as a doorbell can be, and some older doorbells use unexpected components like mercury switches to change the operation of the solenoid. Finding the right wires to connect your NodeMCU to the doorbell might take longer than you expect, because there isn't really any sort of colour code or standard system at play. At the most basic level, there will be a button, a bell with a solenoid, and a transformer. How these individual components are all wired into the bell box will be different for each model and manufacturer. The best plan is to use a multimeter to figure out which wires go to the button and the solenoid, and which wires come from the transformer. Remember that the bell will probably be using AC and not DC electricity, so adjust your multimeter accordingly.

Above ♦ This bell box uses a mercury switch to cut power to the solenoid when the striker hits the bar chime on the right-hand side. A spring returns the striker bar back to strike the chime on the left, and the cycle begins again. The box also supports a secondary bell button, intended for the back door. You can see the red enamelled wires that connect to the solenoid on pins 3 and 4. The blue wires go to the relay on the NodeMCU. When the solenoid gets power, it also powers the relay coil



FreeCAD: using the part design workbench

In this second part of the FreeCAD mini-series, we are going to design a small bird feeder using the 'part design' and 'sketcher' workbenches



Jo Hinchliffe

@concreted0g

Jo Hinchliffe is a constant tinkerer and is passionate about all things DIY space. He loves designing and scratch-building both model and high-power rockets, and releases the designs and components as open-source. He also has a shed full of lathes and milling machines and CNC kit!

In issue 37, we began to look at FreeCAD and used the 'part' workbench to design a small wheel.

We used simple primitive shapes, cubes, and cylinders, and we added, subtracted, and joined them together to create our design. This month we are going to make a small bird feeder, but will use different methods where we will create a 'body' using the 'part design' and 'sketcher' workbenches. The techniques are a little more complex, but give us much more control over our designs.

PICK YOUR WORKBENCH

Opening FreeCAD, start a new document and then select the part design workbench from the drop-down menu. You should see in the combo view, on the left-hand side, a single option which is 'create body' – click this. You will then be presented with two options: 'create sketch' and 'create boolean'. Click 'create sketch'. We are then presented with a choice of which plane to base our sketch in: XY, XZ, or YZ. An easy way to visualise the XY plane is by imagining a 3D printer and looking down on it from above onto the bed. If we sketched onto the printer bed, we are

then working on the XY plane. Select the XY plane and click OK. At this point, FreeCAD should automatically switch to the sketcher workbench.

Next, select the 'create a polyline' tool icon which is 7th from the left on the top row in **Figure 1**. We are going to draw three connected lines in a U-shape roughly laid out, as shown in **Figure 2**. Starting at the top left-hand side of the U, click on the vertical zero-line on the Y-axis at any height and then drag the line down to the origin point of the XY plane. Conveniently, when we hover over either zero-line or any point they will turn yellow; clicking when yellow will place the drawn object on the highlighted point or line. Next, pull the line out horizontally and left-click before pulling it up vertically; right-click to end our three lines. If you have done this correctly, the horizontal line and vertical line will be white, but will have a small red horizontal or respectively vertical line. In the combo view panel, you should see a 'solver messages' tab with a message about numerous 'degrees of freedom'. The aim is to reduce these degrees of freedom to zero by constraining all the items within a sketch. Constraining a sketch is the process of adding constraints that complete all the

Above ♦ The completed bird feeder 3D-printed and attached to a window with small suction cups

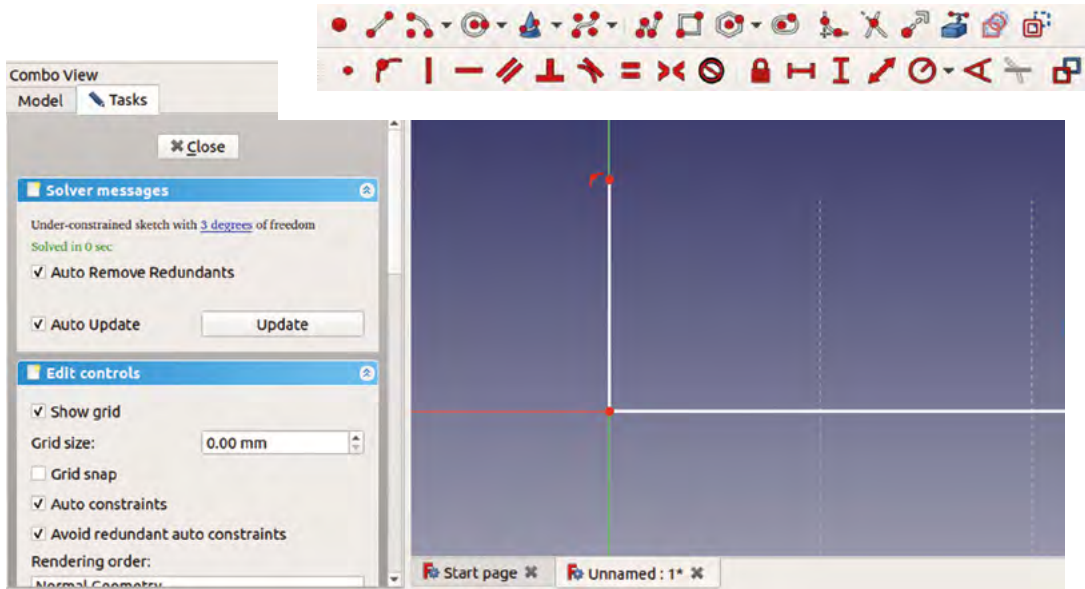

Figure 1 The icons on the top line are mainly the tools for drawing lines, circles, rectangles, and more. The icons on the bottom line are the tools to add different types of constraints

Figure 2 Our first three lines drawn roughly and unconstrained

Figure 3 Our first three lines constrained

information about a sketch item's positions and dimensions. This is an incredibly useful approach, meaning we can return to sketches at any point in our design and make changes that will be automatically recalculated into the whole model.

The sketcher solver automatically adds some constraints when it guesses, for example, you want a line to be vertical or horizontal, as we have just done. Starting on a datum line and including the origin point on the XY plane also means that we don't need to constrain these lines' positional co-ordinates, but we do need to constrain the lengths of the line. Later we will constrain items that aren't on these lines, so you'll see how to set positions of items relative to other parts of the design.

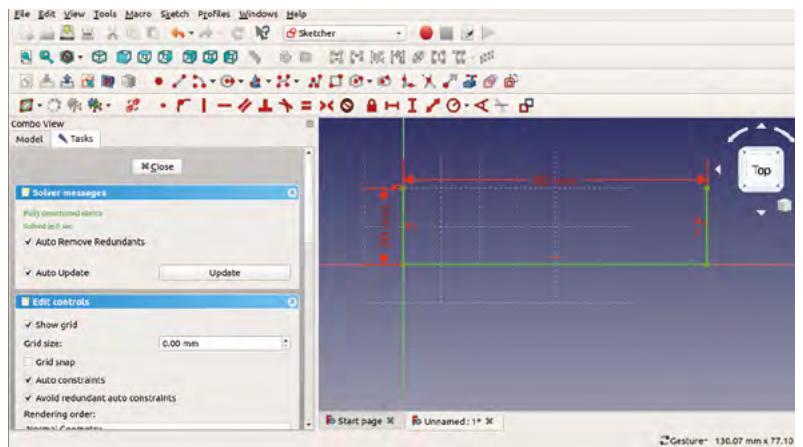

CONSTRAINING CHOICES

As you get used to applying constraints, you will realise that there are lots of different ways to achieve the same results. To constrain our lines, we are going to select the two vertical lines. To do this, right-click to deactivate the line drawing tool and then left-click on both the vertical lines in turn. Next, press the 'create an equality constraint' tool (8th from left, top row, in **Figure 1**). The two lines should now appear as an equal but undefined length. If you left-click on the red point at the top of either line and drag it, you should now find that both lines extend together as they are constrained as equal. This ability to extend the line is a degree of freedom, and sometimes, clicking and dragging items in the sketch can help identify what you need to constrain. Left-click to select one of the →

YOU'LL NEED
A laptop or desktop computer

WHAT IS A BODY?

A body is best described as a component part that is one continuous solid object. To visualise this, an example could be a nut and a bolt. If we wanted to model a nut and bolt, they would both be separate bodies that could then be fastened together as an assembly. The 3D form of a nut and a bolt can be modelled as a continuous single piece, and so each can be considered a body.

In this tutorial, we are using sketches and performing operations on the sketches such as 'padding' where we extrude a sketch, and 'pocketing' where we cut the shape of a sketch into an existing object. However, you can also add primitive objects on the part design workbench similar to the use of the part workbench in issue 37 (hsmag.cc/issue37).

TUTORIAL

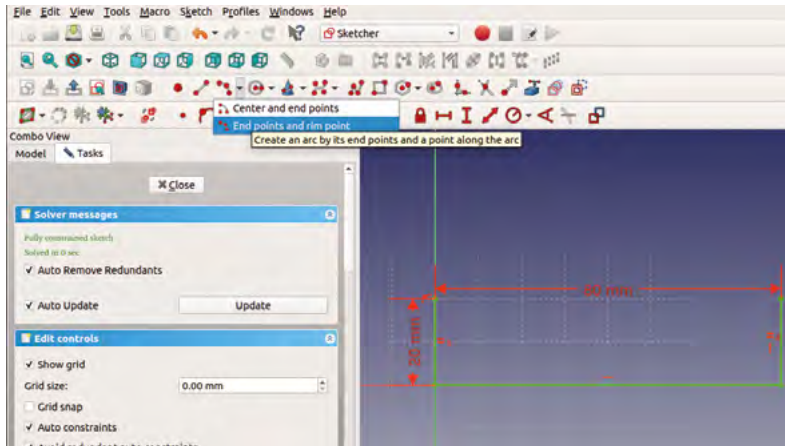

QUICK TIP

You can use the constraint tools in different ways – you can select the sketch item and then click the constraint tool, or you can select the tool first and then click the item or items.

vertical lines, and then click the 'fix the vertical distance' tool icon (13th from left, top row, in **Figure 1**). In the dialogue box that appears, type '20 mm', and then click OK. You should now see a red constraint label with '20 mm' in the viewer window – both vertical lines are now set to 20 mm. If you ever want to change this value, double-click on the constraint in the viewer window and the dialog box will reopen. You can click and drag the constraint around in the viewer window, and as you add more detail and constraints, you might do this to keep things clear.



The first job is to make a pocket for our bird feed to be contained in

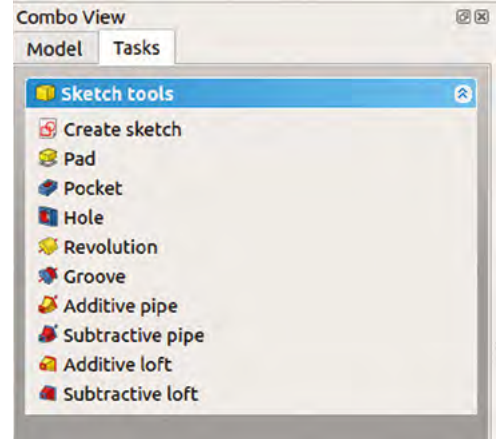
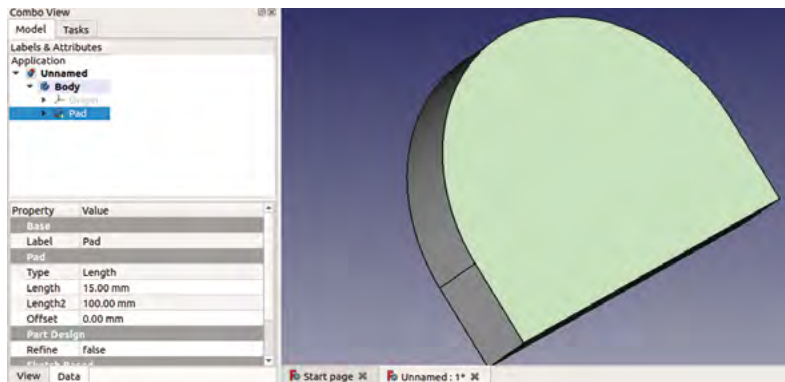

Figure 4 ♦ Some drawing tools have drop-down menus and options for their use, such as the 'create' and 'arc' tools

Figure 5 ▣ The part design workbench task menu tab

Figure 6 ♦ Selecting a face and clicking the 'create sketch' tool to launch a sketch attached to that face

Next, select the horizontal line and click the 'fix a horizontal distance' tool (12th from left, bottom row, in **Figure 2**) – set this length to 80 mm. You should now see that the sketch as it stands is fully constrained, the solver says there are no degrees of freedom, and that all lines are green (**Figure 3**).



A BIT SKETCHY

We are going to add more to the sketch, though. Let's click the 'create an arc' tool icon, but click its drop-down menu and scroll to the 'end points and rim point' option (**Figure 4**). Hover over the uppermost point of the left-hand vertical line until the point becomes yellow, single left-click, and then move across to the top point of the right-hand vertical line and left-click again – this creates the end points of the arc. Next, move up and towards the centre of the two vertical lines to finish the arc roughly in the correct place. To constrain the arc – as the end points are already constrained – we just need to set the radius of the arc. Highlight the arc line and then click the 'constrain an arc or a circle' tool icon (15th from left, bottom row, in **Figure 2**), and in the dialog box, set the radius to 40 mm. We should now have a fully constrained sketch, with all lines turned green.

This sketch is the main outline of our bird feeder, so click 'close' on the sketch solver panel in the combo view window, and we will return to the part design workbench. Make sure that the sketch you drew is highlighted in the file tree, then click the 'tasks' tab just above the file tree view. Click 'pad', and then type '15 mm' in the dialog box to set the thickness of the pad/extrusion (**Figure 5**).

For the rest of this project, we are going to create more sketches, but these sketches are going to be drawn onto faces of the pad object we have just made. The first job is to make a pocket for our bird feed to be contained in. So, left-click in the viewer to select the upper face of our object (**Figure 6**). Then click the 'create sketch' tool icon which should now bring you back into the sketcher workbench with the face of the pad we selected in view. Click the 'create a circle' tool icon (4th from left, top row, in **Figure 2**). Left-click and drag and left-click again to draw a circle

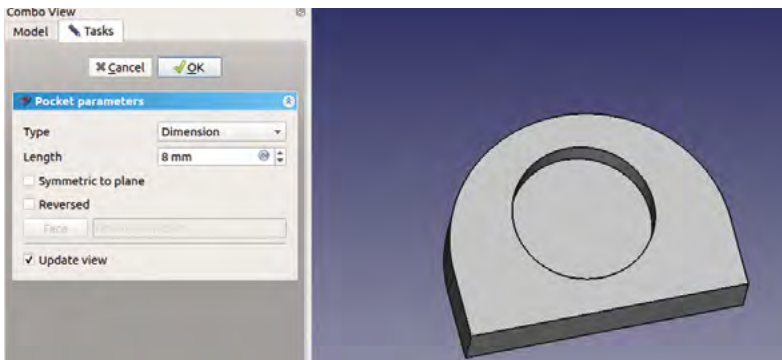

Figure 7 ♦
Setting parameters to create a pocket from a sketch

Figure 8 ♦
Laying out sketches for further pockets in our bird feeder is made easier by importing geometry from pre-existing parts of the design

of any size anywhere in the sketcher viewer. Use the 'constrain an arc or circle' tool we used earlier to set the diameter to 20mm. Next, click to select the centre point of your circle, and then click the zero point of the axis at the bottom of the left-hand vertical line. To position our 20mm circle, click the 'horizontal distance constraint' tool we used earlier and set the distance to the midpoint of our feeder, which is 40mm. Next, set the vertical height of the centre point of the circle relative to the zero point at 30mm. This should place it nicely centralised in the feeder design and should be fully constrained. Close the sketch, and with this new sketch highlighted in the file tree, click 'pocket' from the list on the 'tasks' tab. You should now see that it's cutting our circle as a pocket into our bird feeder design. We set the depth of our pocket to 8mm (**Figure 7**).

A STICKING POINT

To attach our bird feeder, we are going to create a pocket and a slot which we used to fit some rubber window suckers that we found in our parts drawer. The arrangement of the slotted pocket could allow the bird feeder to slot onto a couple of small screws. In the part design viewer, we rotated our bird feeder and selected the bottom of the design opposite to the pocket we had just created. As before with this selected, we clicked the 'create a sketch' tool. Next, select the 'create a rectangle' tool icon (8th from left, top row, in **Figure 2**). Draw two rectangles of any size anywhere in the sketcher window. Conveniently the rectangle drawing tool constrains the vertical and horizontal lines, so all we have to add is the line lengths and the positions. We made our rectangles 10mm by 6mm. Then we used the zero axis point to locate the closest rectangle to it, 10mm across and 4mm down from the straight edges of the design (using the horizontal and vertical distance constraint tools and a corner point of the rectangle, as we have done with other items). However, to position the other rectangle, we used a clever little function. By clicking the 'create an edge linked to an external geometry' tool (14th from left, top row, of **Figure 2**), we can select and import lines from the underlying

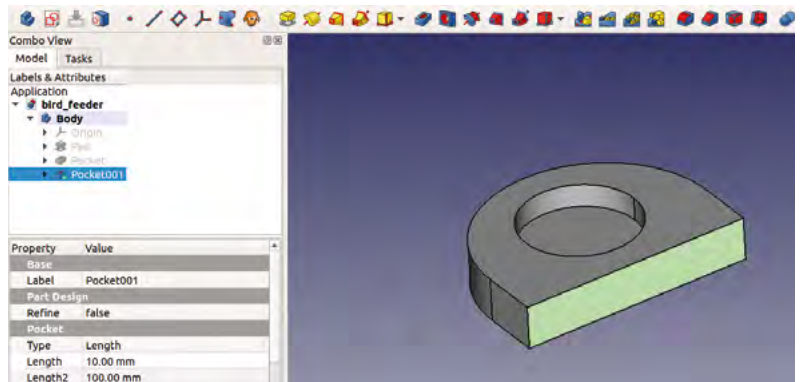
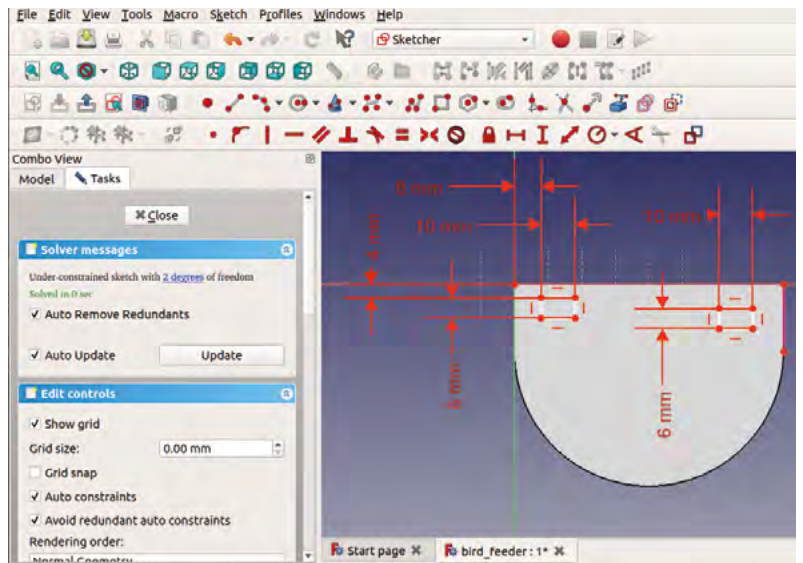

object which aren't in this sketch. We hovered over the 20mm vertical line at the far edge of our bird feeder and selected it, once highlighted. This now creates an edge and points at either end to which we can attach objects or constraints. This means that instead of calculating the position of our other rectangle from the XY zero origin point, we can now constrain this by saying it is 10mm and 4mm from the opposite corner of the object; you can see where we connected that rectangle tool in **Figure 8**. →

Figure 9 ♦
Selecting the back face of the bird feeder to draw the slots for the suction cups

TUTORIAL

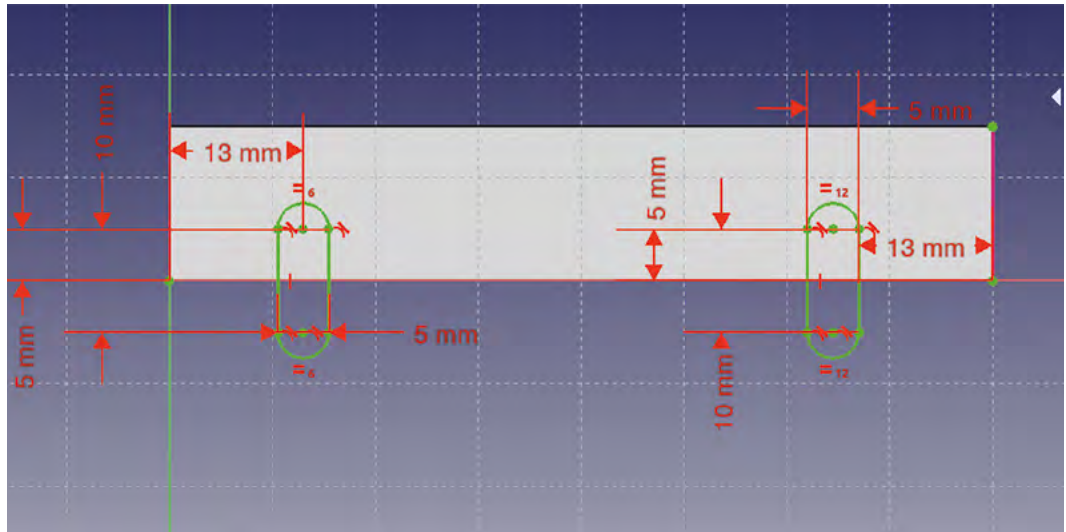

Figure 10 ♦ Fully constrained slot sketch ready to be cut as a pocket

Figure 11 ♦ Selecting the entire upper face and adding a 2mm fillet is easier than selecting the individual edges

Having constrained our rectangles sketch, we closed the sketch and performed another pocket operation to a depth of 10mm. Next, we need to cut slots that go into these pockets, so we selected the face of the back of the bird feeder object that we need to sketch on and created a new sketch (**Figure 9** overleaf).

// **We closed the sketch and performed another pocket operation to a depth of 10 mm** //

FINISHING OFF

In this sketch we again imported and created an edge for the far side of the object and then used the 'create a slot in the sketch' tool (10th from left, top line, in **Figure 2**). This tool works similarly to the rectangle tool but creates a pill-shaped slot item. Similarly again, some of the edges and arcs are partially constrained. You can constrain these in multiple ways, but we opted to select two opposite points on either side of the slot and constrain the horizontal distance between them to 4mm. We then constrained just one of the vertical lines to 10mm as both sides are considered an equality. With a fixed width and height, there is no

need to constrain the arc, and so we only needed to position the slot sketches in the correct places to coincide with our rectangular pocket. We used the point at the centre of the top end of each slot (the centre point of the radial arcs) to position the slots to coincide with the rectangle pockets – you can see these values in **Figure 10**. We closed the sketch and again performed a pocket, setting the depth to 5mm, to cut into our rectangular pocket, but not deeper into the object.

Finally, we added a fillet to the edge of the top of the feeder and the feeder bowl by selecting the top face of the feeder and clicking the 'fillet tool' icon and setting the fillet radius to 2mm (**Figure 11**). We covered usage of the fillet and chamfer tools last month in the part workbench, but they work similarly on the part design workbench.

Hopefully, you now have a feel for how sketching and constraints work – the great advantage being that, if you want to change a dimension or position at a later date, you can click through to find the underlying sketch constraint, edit it, and the whole design relating to that change will be updated. It's a powerful and useful way to work. □

QUICK TIP

In this tutorial, we have mainly created sketches on our object and pocketed them, but, of course, you can create sketches and extrude them just as easily using the 'pad' tool.

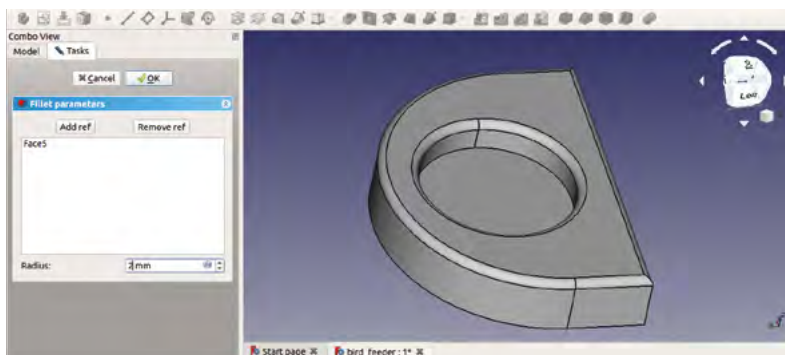

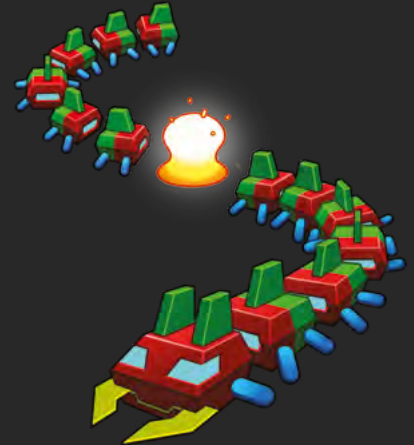
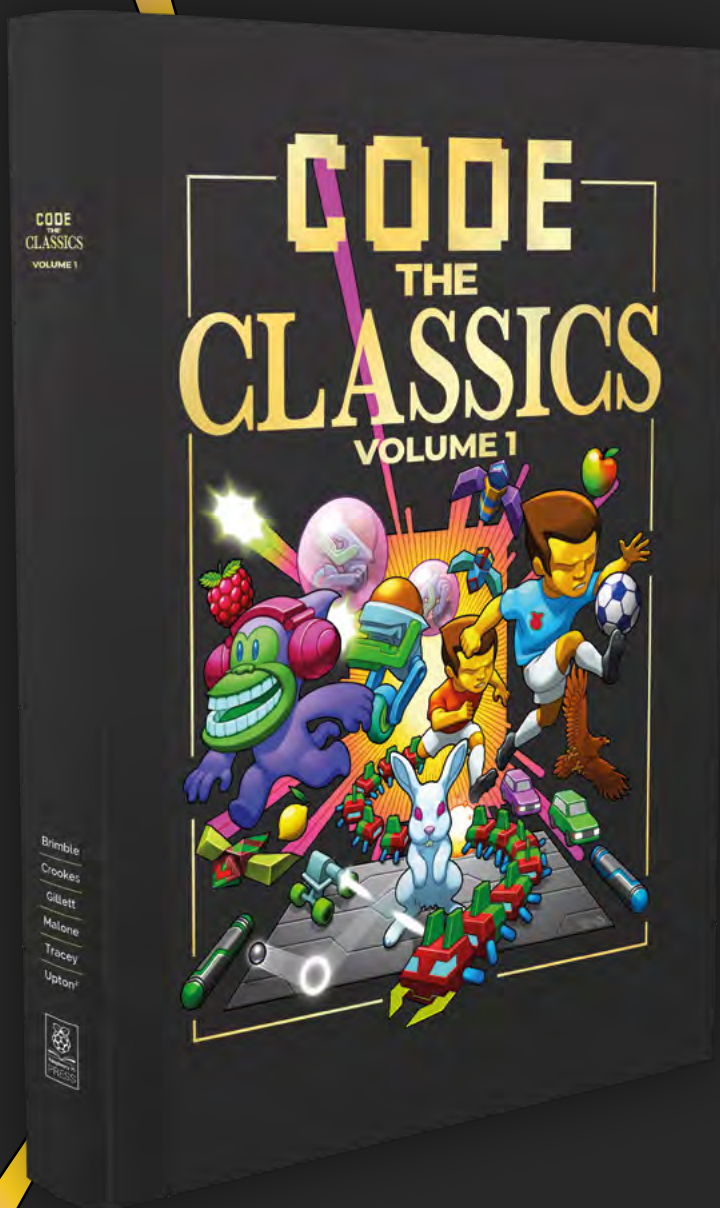

- *Get game design tips and tricks from the masters*
- *Explore the code listings and find out how they work*
- *Download and play game examples by Eben Upton*
- *Learn how to code your own games with Pygame Zero*

This stunning 224-page hardback book not only tells the stories of some of the seminal video games of the 1970s and 1980s, but shows you how to create your own games inspired by them using Python and Pygame Zero, following examples programmed by Raspberry Pi founder Eben Upton.

Available now: hsmag.cc/store

Making music with the Makey Makey

Bring household objects to life



Helen Leigh

@helenleigh

Helen turns all sorts of unusual items into musical instruments (among other things).

Below This project also works with ripe bananas

Even the most technology-averse people I know have been won over by the easy-going charm of the Makey Makey. Setting it up takes seconds: it requires no code or intimidating soldering skills, and it is pretty much foolproof.

There are loads of ridiculously fun games and widgets you can play with it: I find myself breaking out my Makey Makey at parties with friends to play Super Mario Bros. with high fives, and also at family holidays with my nieces to code and play interactive games.

The Makey Makey transforms household items, food, and clothing into touchpads that can be used for whatever fun invention you can dream up, from the infamous banana piano to quiz buzzers, voting machines, or unconventional game controllers. The board works by opening and closing circuits, just like a button or a switch. In a Makey Makey circuit, you connect a conductive object (such as metal things, or things with a high water content – like fruit or your body) to the board with crocodile clips, then close the

circuit by connecting to ground. It's a simple concept but it provides endless delight, especially to those who are new to electronics.

One of my favourite ways to introduce the delights of this board to my friends and family is by making instruments. You can watch a fantastic introduction to the possibilities of making experimental instruments with Makey Makey on YouTube following this link: [hsmag.cc/MusicExamples](https://www.hsmag.cc/MusicExamples). In this article, I'll be showing you the basic workings of this board through my three favourite crowd-pleasing Makey Makey instruments: the classic banana piano, a hilarious set of jelly bongos, and a *Big*-inspired giant floor piano.

PART ONE: FRUIT PIANO CHOOSING YOUR FRUIT

The most traditional fruits to play piano on are bananas. Making an instrument out of bananas is a rite of passage for instrument makers, but this project works equally well with any juicy fruit: apples, star fruit, tomatoes, or wedges of melon. Once you have selected your fruit, it's time to get arty and arrange it into a perfect playable still life composition.

WIRING YOUR FRUIT

Time to wire up your fruit. You can remove the plastic coating from one end of a crocodile clip and stab it in, or if you don't want the end of your crocodile clip to get sticky, you can use a paper clip. Push the paper clip into the fruit until only a small semicircle is sticking out, then attach a crocodile clip to that semicircle. Repeat this process for each of the five pieces of fruit.

CONNECTING TO THE MAKEY MAKEY

Your five pieces of fruit will correspond to five notes on a keyboard. Decide which fruit you want to be the lowest note, then connect the free end of the crocodile clip attached to that fruit to the left arrow on the Makey Makey.

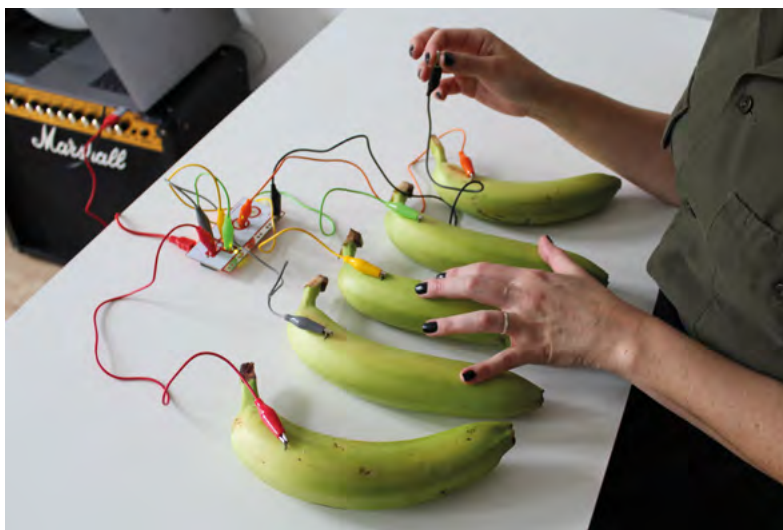

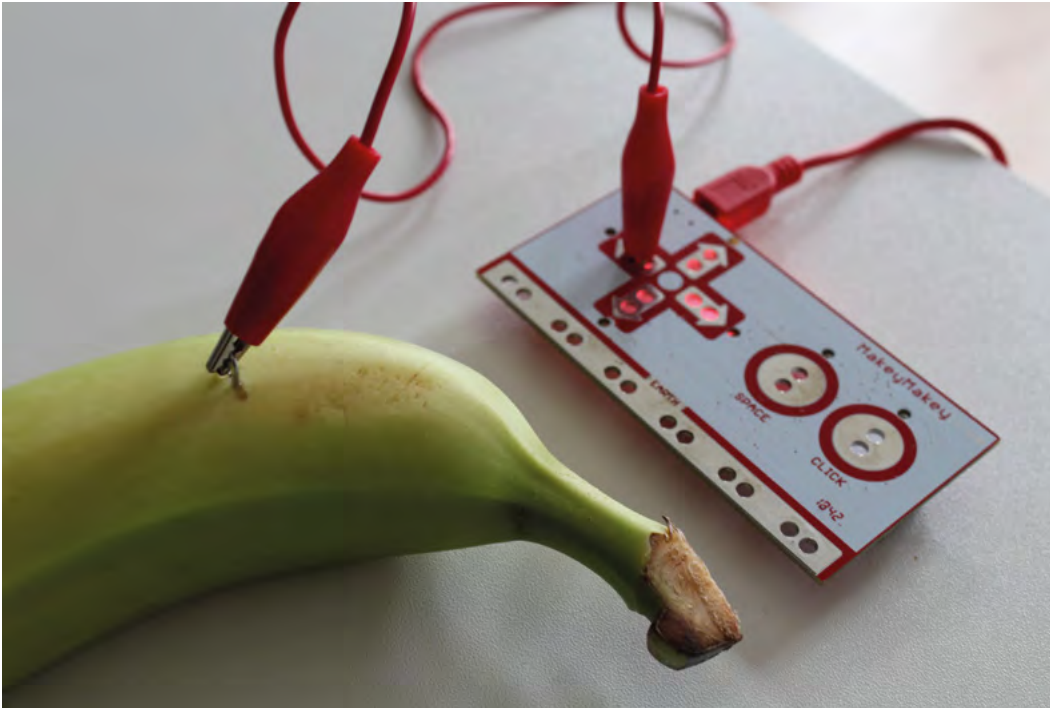

Left ♦
Get ready to harness the electrical power of fruit

The next note in your fruit piano should be attached to the up arrow on the Makey Makey, then the right arrow, then the down arrow, and finally the **SPACE** circle, which will be the highest note on your fruit piano.

GROUNDING YOURSELF

The Makey Makey triggers a note when you complete a circuit. To complete a circuit by touching one of your pieces of fruit, you'll first have to connect yourself to the earth strip of the Makey Makey board. Attach a crocodile clip to one of the spaces on the earth strip, then hold the metal part of the other end of that crocodile clip in your hand.

PLAYING YOUR FRUIT PIANO

Your fruit piano is almost ready to play! Use the USB cable that came with your Makey Makey to connect your board and your computer. Open up your browser and go to this URL: apps.makeymakey.com/piano/.

With your earthed crocodile clip firmly in one hand, touch one of your wired pieces of fruit with the other.

GOING FURTHER: MORE FRUIT, MORE FUN

You can have a lot of fun with five notes, but if you want to add a little extra range, you can flip your Makey Makey over and plug in some M to M jumper cables to access the **W**, **A**, **S**, **D**, **F**, and **G** keys, as well as your up down, left, right, and **SPACE** keys. One really fun thing to do with all these extra notes is to head over to ericrosenbaum.github.io/MK-1 in your browser. Eric Rosenbaum is the co-inventor of the Makey Makey, and he has made a fantastic little keyboard so you can

use your board to play with different sounds, including vibraphone, kalimba, and splurts. You can even record your own sampled sounds – this little keyboard is epic amounts of fun!

PART TWO: JELLY BONGOS

Banana pianos get all the fame and glory, but my personal favourite introduction to harnessing the power of electricity for joyful creativity is making a pair of bongo drums out of jelly. There's just something inherently funny about wobbling, tapping, or slapping a jelly and hearing it make percussive sounds. Aside from making the jelly, this project is even simpler than the banana piano, making it perfect for doing with even the littlest children. It also only uses two inputs, so you can do this project with either the Makey Makey Classic, or the cheaper Makey Makey GO. →

Below ♦
Helen's entry into *The Great British Bake Off* is still pending



YOU'LL NEED

- ♦ 5 × pieces of fruit (see part one)
- ♦ Makey Makey
- ♦ USB connector
- ♦ 5 × crocodile clips
- ♦ 5 × paper clips
- ♦ M to M jumper cables (optional, if you want to add more notes)

Makey Makey: Classic or GO

- ♦ USB connector
- ♦ 2 × paper clips
- ♦ 3 × crocodile clips, ideally 30 cm or longer
- ♦ 2 × jellies (see part one)

Makey Makey Classic (version 1.2 or above)

- ♦ 2 × extra-large sheets of card, or a yoga mat
- ♦ Copper tape with conductive adhesive
- ♦ Duct tape: silver and black
- ♦ Roll of kitchen foil, approx. 30 cm wide
- ♦ Crocodile clips, the longer the better
- ♦ Jumper cables
- ♦ Scissors
- ♦ Glue stick

TUTORIAL



Warning: showing a six-year-old how to play the jelly bongos may result in minds being blown. It may also prove difficult to persuade them to stop running around the house trying to find other strange things to plug in and play. Introduce children to the joys of noisy wobbling jellies at your own risk.

MAKING THE JELLIES

There are lots of different ways to make jelly. When you're making jelly that needs to hold a shape, like I

did for these moulded jelly bongos, you need to make it structurally sound. I made mine with fresh fruit and powdered gelatine. I can't quite believe that I'm about to include a recipe in a musical instrument write-up, but my experiments with making a jelly that holds up to being played as a bongo failed often enough that I think it's worth recording my method.

The following recipe is enough for one very big, very sturdy jelly, or two smaller jellies.

Ingredients

- 120g gelatine powder (I used Dr. Oetker Gelatine Fix)
- 300g caster sugar
- 1 kg raspberries
- 1 lemon's worth of juice
- 600ml water
- ½ tsp flavourless oil for greasing, such as sunflower oil

Tools

- Measuring jug
- Jelly moulds
- Sieve
- Very big saucepan

METHOD

Heat the water and sugar on a medium heat and stir until the sugar is dissolved. Add your raspberries and then bring the mixture to the boil, then turn the heat down to a simmer for five to ten minutes until the fruit breaks down.



Above  Bom buda bom buda
bom buda bom

Right  The guitar is put
away, and the serious
musical instruments
have come out

Pour this liquid through your sieve into a measuring jug, then stir in the lemon juice. Next, you need to add in your gelatine. The type I used could be added straight in, but some powders need to be 'bloomed', and gelatine leaves need to be soaked. Give the whole mixture a good whisking until the gelatine is dissolved properly.

Lightly grease your moulds with flavourless oil, then pour your mixture into the greased moulds. Put the whole thing in your fridge overnight until set. When set, dip the mould into a sink filled with hot water for 30 seconds. Take a plate, place it on top of the jelly mould, and tip the mould over onto the plate. Your jelly should be free, ready for your sound experiments. If not, dip the mould back into the hot water again for a little longer.

Remember, these jellies need to be slappable, so if you think your jellies are too soft, you can boil the mixture again and add more gelatine.

CONNECTING TO THE MAKEY MAKEY

Take your two jellies and set them down side by side. Take your paper clips and unwind them until you are left with a long bit of wire with one curved loop at the end. Push one unwound paper clip into each jelly, until there is only a semicircle left visible, just like in the banana piano above.

Clip one crocodile clip to each jelly using the protruding semicircle of the paper clip. Attach the other end of the crocodile clips attached to the left jelly to the left arrow, and the crocodile clip attached to the right jelly one to the **SPACE** circle. Finally, attach another crocodile clip to the earth strip on your Makey Makey.

PLAYING YOUR JELLY BONGOS

Connect your Makey Makey to the computer using its USB cable. Then open up your browser and go to apps.makeymakey.com/bongos. With your earthed crocodile clip firmly in one hand, tap one of your jellies with the other. Playing two bongo drums is best done with two hands, so it may feel a little clumsy to hold the earth crocodile clip in your hand as well. To get hands-free, you can attach your crocodile clip to a metal bracelet or make your own with tin foil.

PART THREE: GIANT FLOOR PIANO CREATING THE KEYS

Roll out your yoga mat, or lay out your card on the ground. This will form the base for your keyboard. Cut four 60cm long strips of kitchen foil, then cut each of these in half, lengthways. This should give you eight strips of foil measuring 60cm long by 15cm wide.

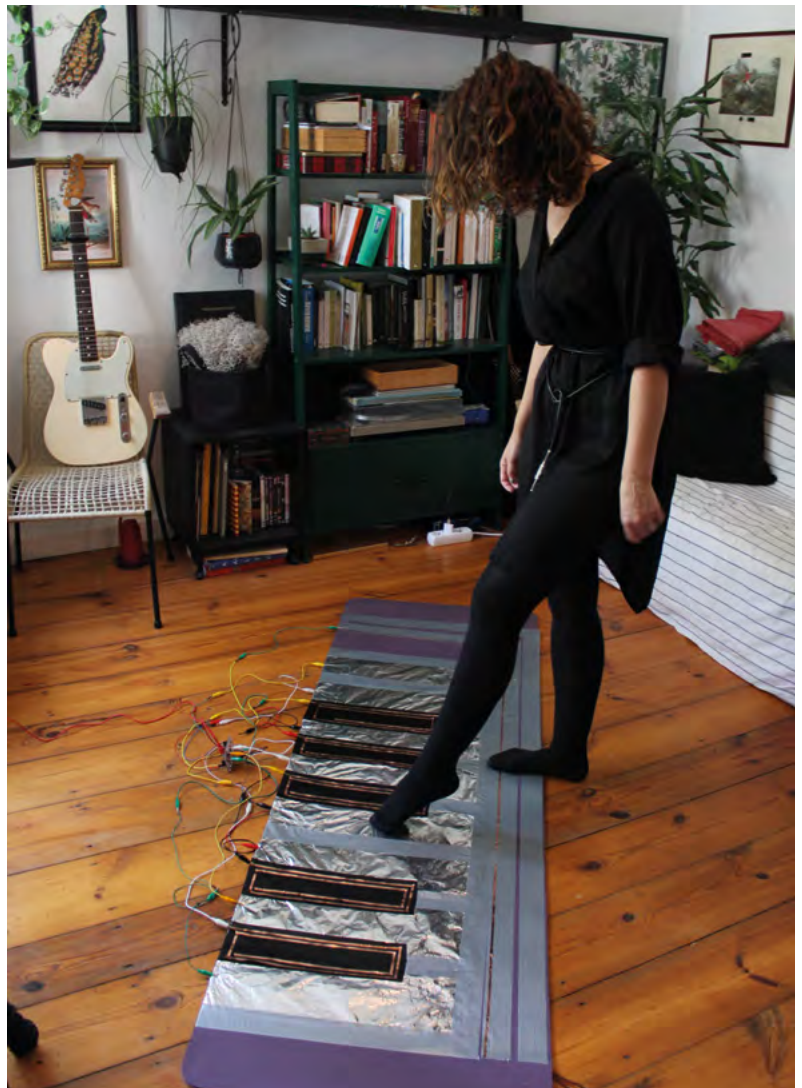

Position this foil on your base, like keys on a keyboard. It is very important that the pieces of foil are not touching each other. Anchor each strip by folding around 10cm foil over the top edge of the base, creating a lip. Once you have done this for all eight of your keys, use silver duct tape to stick down the edges of the keys, creating dividing lines of silver duct tape between each key and at both ends.

ADDING IN AN EARTH RAIL

Next, you need to add in an earth rail. Firstly, add silver duct tape to the bottom edge of your base to keep the bottom edge of your foil keys in place and provide a nice insulated path for your earth rail. Then, carefully apply a long strip of copper tape along the middle of this path until you get past your foil keys. Then, take the path of your copper tape up towards the top of the base along the far right edge of your keys, until it reaches the top of your mat. Fold a 5cm section of →

Above ⚠ Warning! This project will add a significant amount of time to your morning routine as you just have to pop out one more tune before going to work

TUTORIAL



copper tape underneath the mat to anchor it, then snip it off: your earth rail is done.

While laying down the earth rail, make sure that your keys and the copper tape do not touch at any point, and that your copper tape rail is unbroken. If it rips, it is not a big deal! You can fix it by placing another strip of copper tape directly on top, patching the two bits together. If your copper tape does not have conductive adhesive, you can simply flip a section of copper tape upside down so that the conductive bit forms a bridge, and secure it in place with ordinary sticky tape.

ADDING IN SHARPS

To make your giant floor piano realistic, you now need to add in the five sharps, which are the black keys on a normal piano. Use black duct tape to add in the space for your five sharp keys. As well as looking the part, this black duct tape will insulate the foil keys from anything above it. Once your duct tape sharp keys are in place, you can use your copper tape to create a path on each of the black keys that will trigger your Makey Makey. Each of these paths needs to extend to the top

of the mat so you can connect them to your Makey Makey. Remember to make sure that your copper tape does not touch your foil at any point, either on the top of your floor piano or underneath your base.

WIRING YOUR GIANT FLOOR PIANO

You now have eight foil keys and five black and copper tape sharp keys. Clamp one end of a crocodile clip to each key and also to the ground rail. To connect them to your Makey Makey, you'll need to connect each of these crocodile clips to an M to M jumper cable by clamping the metal pin of the jumper cable in the jaw of the crocodile clips, securing it in place with duct tape. You may also need to daisy-chain two crocodile clips together to reach the Makey Makey, using duct tape to secure the two connected jaws of the clips.

REMAPPING THE MAKEY MAKEY

All the other Makey Makey instruments we've made so far have been connected to the board using crocodile clips. In this make, we need to connect 13 keys to our board: more keys than we have space for crocodile clips. You'll need to flip over the board, where you'll find a bunch more spaces for inputs, this time with headers that we can slot our jumper cable pins into. You'll notice that the row of headers on the right has pins for the usual up, down, left, and right, but that we also have a bunch of new keys on the left: **W**, **A**, **S**, **D**, **F**, and **G**. Add those to the **SPACE** circle, which you can also access from the bottom of the board using crocodile clips, and you've got eleven keys.

To get to our desired number of 13 keys, you need to remap the pins that are currently assigned to left and right mouse clicks. To do that, go to makeymakey.com/pages/remap and follow the on-screen prompts to map the left click pin to the letter **J** and the right click pin to the letter **K**. Once you've saved your new mapping, you can unplug your Makey

Above  Tinfoil, tape and a yoga mat: the basic ingredients of a floor piano

Below  Assembly finished. Now to add some wires





Makey from your computer and start connecting your giant floor piano.

CONNECTING THE MAKEY MAKEY

Connect your foil keys up first, going from left to right. The key on the far left is a middle C, which you'll need to connect to the pin for the left arrow, which you'll find in the row of headers on the right-hand side of the back of the board. Proceeding in order towards the right, connect the next key, D, to the up arrow pin, then E to the down arrow pin, then F to the right arrow pin. The next key along is G, which needs to be attached to the **SPACE** circle, using your crocodile clip as there is

// If you want to try playing more than one note at once, you can team up with friends or family by holding their hand //

no header pin for the **SPACE** input. Connect the next key to the right, A, to the **W** pin, which you'll find in the row of headers on the left-hand side of the back of the board. Connect the next key, B, to the **A** pin and the final foil key, C, to the **S** pin.

Now all your foil keys are connected, you can add in your black keys, the sharp notes. The leftmost black key is a C#, which you need to connect to the **D** pin. Connect the next black key to the right, D# to the **F** pin, and the next black key, F# to the **G** pin. Our final two black keys need to be connected to the pins we

remapped earlier. First we have G#, which needs to be connected to the **J** pin (the pin labelled with a left click icon) and then connect A# to the **K** pin (the pin that is labelled with a right click icon).

Finally, connect your earth rail to one of the GND pins on the top row of headers on the back of the board.

PLAYING THE GIANT FLOOR PIANO

Now all your keys are wired up, connect your Makey Makey to your computer using its USB cable. Open up your browser and go to hsmag.cc/ScratchPiano. Click the green flag and you can start playing!

The code for this piano was made in an awesome visual programming environment called Scratch. The person who wrote this code is called Colleen Graves, and Colleen is a librarian, tech wizard, and the author of my absolute favourite book on the Makey Makey, *20 Makey Makey Projects for the Evil Genius*. You can take a look at Colleen's code, or even remix it to make it higher, lower, or with different sounds using the Scratch editor by following this link: hsmag.cc/PianoEditor.

Stand in front of your piano and place one foot on your earth rail. Now, use your other foot to play one of the keys. You can now play barefoot melodies! If you want to try playing more than one note at once, for example, chords or duets, you can team up with friends or family by holding their hands. They will be connected to earth through your hand, so they don't need to connect to the earth rail as well – leaving you with more limbs for playing notes! □

Left □
Crocodile clips are great for physical projects

Below ◆
There's a lot of wires, but it's not too complex if you check it as you go along

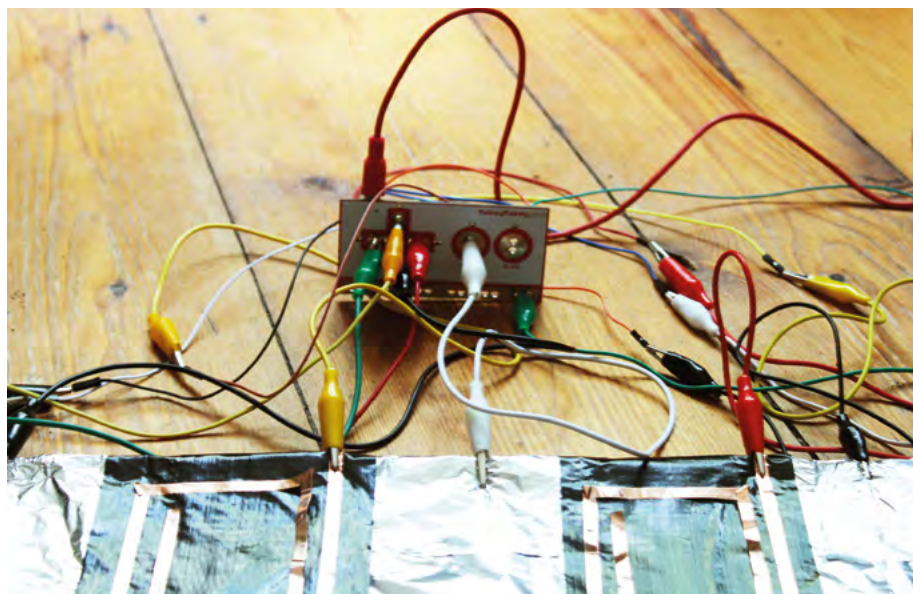

DON'T MISS THE **BRAND NEW** ISSUE!

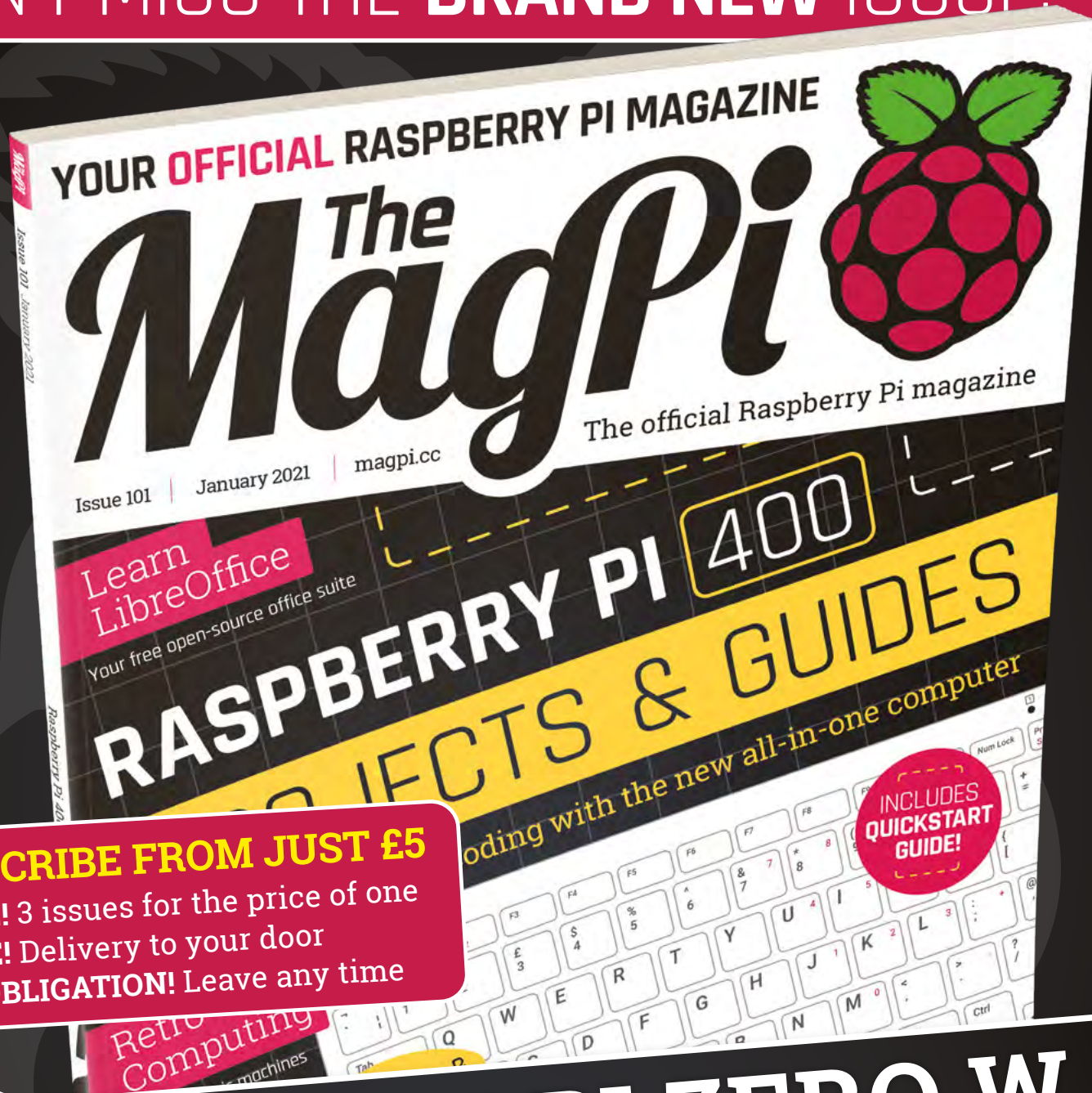

SUBSCRIBE FROM JUST £5

- ▶ **FREE!** 3 issues for the price of one
- ▶ **FREE!** Delivery to your door
- ▶ **NO OBLIGATION!** Leave any time

**FREE PI ZERO W
STARTER KIT***

With your 12-month subscription to the print magazine

magpi.cc/12months

* While stocks last



Buy online: store.rpipress.cc

FIELD TEST

HACK | MAKE | BUILD | CREATE

Hacker gear poked, prodded, taken apart, and investigated

PG
108

DIRECT FROM SHENZHEN: AIR COMPRESSOR

Squeeze air without taking
up too much workshop space

PG
110

ADAFRUIT QT PY

A tiny microcontroller
with a lot of connectivity

PG
112

SPARKFUN MICROMOD

Modular processors let you
pick and mix form factors

PG
102

BEST OF BREED

Make some noise with these musical
electronics kits





A collection of tools for sound makers

Things to help you sculpt that perfect sound

By Marc de Vinck

 @devinck

W

e know that this month's Best of Breed is going to open up a proverbial can of worms. The online community of circuit benders, music makers, and audiophiles is a passionate

group with very strong opinions on what is considered the best. That's not a bad thing! But knowing just how many kits and products are available out there, coupled with a huge and passionate community, it was really hard to pick 'the right ones'.

So, after a lot of research, looking at some of the kits we've made in the past, and scouring hundreds of sites, we've come up with a collection of music makers, most of them being in kit form. And to further narrow the topic down, none are the ever-popular Eurorack form factor derivatives, as that's best left for another roundup.

Again, there are what seem to be hundreds of synths, drum samplers, and sequencers out there. From the simple Atari Punk Consoles, to very advanced and complex ones, like the x0xb0x. So, in this roundup, we're including some of the music-making products that caught our eye for one reason or another. And if it's a popular topic, we can certainly round up more for next time!

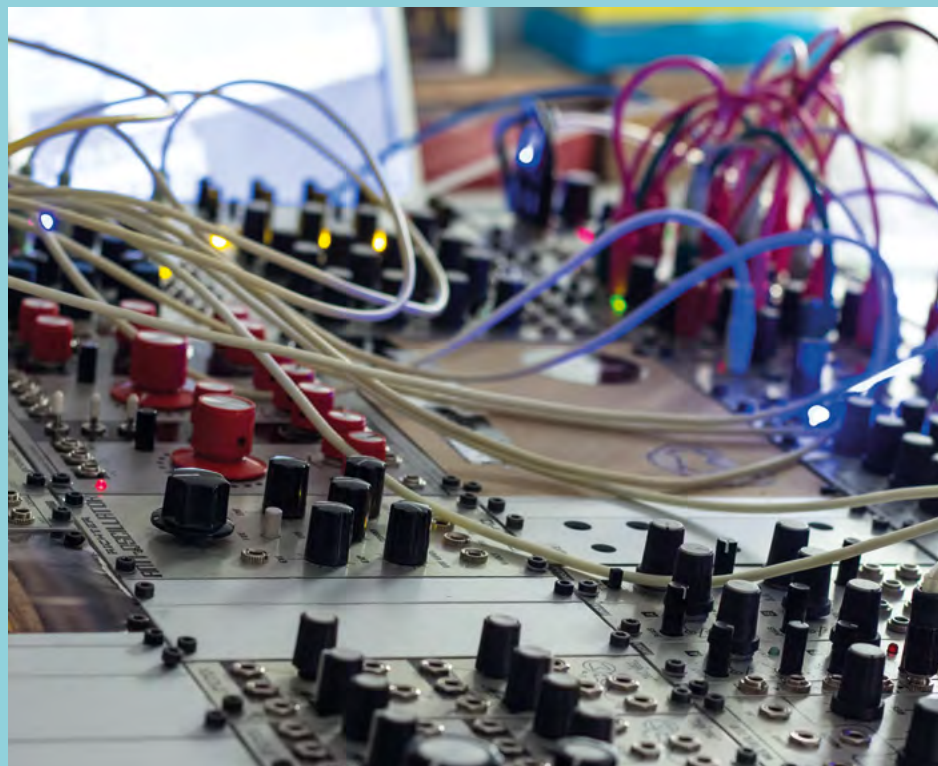

Modal CRAFTrhythm vs Nu:Tekt NTS-1

MODAL ♦ \$129.99 | kraftmusic.com

KORG ♦ \$99.99 | korg.com

What really caught our eye with the Modal CRAFTrhythm eight-track drum sampler kit is the form factor. We really like

how it's not the standard flat PCB. OK, the PCBs are flat, but

once assembled they take on the form factor of a cool vintage sequencer of synth. And calling this a kit is a bit of a stretch. Yes, you assemble it, but this is not a typical DIY soldering kit. It's a simple assembly that can be done in less than ten minutes.

The CRAFTrhythm's main features are an eight-track drum sampler kit and a 16-step sequencer. Couple them together and you can get some pretty interesting sounds and sequences. Each of the 16 tracks features a mixer, adjustable tune control,



Left ▣ PCBs in three dimensions

VERDICT

Modal CRAFTrhythm

Great sound, but less portable than other synths.

9/10

Nu:Tekt NTS-1

Great sound from a legendary company.

8/10

If you ask any serious synthesizer player to name one of the big players in the industry, you are certainly going to hear the name Korg quite often. However, you might not think of the firm as a kit maker. And although the Nu:Tekt NTS-1 is another product that is not the typical DIY solder kit, you do, in fact, build it from a box of parts. Tools are included too! But sadly, no soldering is required!

The Nu:Tekt NTS-1 is a first of its kind: a DIY kit in Korg's Nu:Tekt line of products. It features a classic Korg synth and a multi-effects engine in a small form factor that is incredibly portable and yet still powerful. It includes a single monophonic digital oscillator, three LFOs, one multi-mode filter, three stereo effect processors, a full arpeggiator, and more.

The main oscillator has all the classics like sawtooth, square, triangle, and VPM waveforms. The on-board effects are inspired by their popular minilogue xd polyphonic analogue synth. And just like all the synths in this roundup, your best bet is to head online and listen to what this kit from Korg can do. →

sample selector, low-pass filter, and three envelopes for amplitude, filter, and pitch.

Also, when using Modal's CRAFTapp, available for free on most computer platforms, including mobile apps, you can upload your own sounds for almost unlimited possibilities. There are so many features; you really need to head over to the product page for more info. And if you are interested in this kit, do a quick search on YouTube for some great demos.



Left ▣ Build-your-own Korg

8-Bit Power Synthesizer

HANDMADE ELECTRONIC INSTRUMENTS ♦ \$130 tindie.com

The 8-Bit Power Synthesizer, designed by Handmade Electronic Instruments, had a great demo video on the firm's Tindie site. What caught our attention was the minimalistic design of the keyboard, along with the variety of tones the unit was capable of producing. You really hear undertones of classic 8-bit arcade games that bring back so many memories.

While the 8-Bit Power Synthesizer has just a single octave keyboard, an octave control knob allows you

to sweep through a full six octaves. Just keep in mind that it's monophonic, meaning only the highest key pressed will actuate the sound.

There are seven different modes, including a square wave, oscillating octave mode, ramping octave mode, minor pentatonic arpeggios, vibrato, random octave mode, and lastly a drum loop mode. The whole unit is able to handle all those modes with a nice clean, albeit 8-bit, tone. Another nice feature is the aluminium enclosure with a custom NES-inspired grey paint.



Left ♦
It sounds better
than it looks

VERDICT

8-Bit Power
Synthesizer

Minimalistic in
design, but not
in features.

10/₁₀



Touch Synthesizer

HANDMADE ELECTRONIC INSTRUMENTS ♦ \$45 tindie.com

Above ♦
The touch pads
are pressure-
sensitive

At first glance, the **Touch Synthesizer by Handmade Electronics Instruments** looks beautiful, but a bit sparse. But then you flip it over, and that's where all the good stuff is hiding! The synthesizer is played by touching one of the 15 unique contact points along the front edge. Being monophonic, you can only play one tone at a time, but you are able to manipulate that tone via the three control knobs above.

You can also adjust the pitch simply by how much pressure is applied to the touch sensors. Also, not obvious at first, the pads that flank the 15 touch sensors are actually effects pads. Touch them for some really wild transformations of your sound. Grab a ¼" cable and an amp to get started making some interesting sounds. And the battery is included! →

VERDICT

Touch
Synthesizer

Interesting
sounds and
interface.

9/10

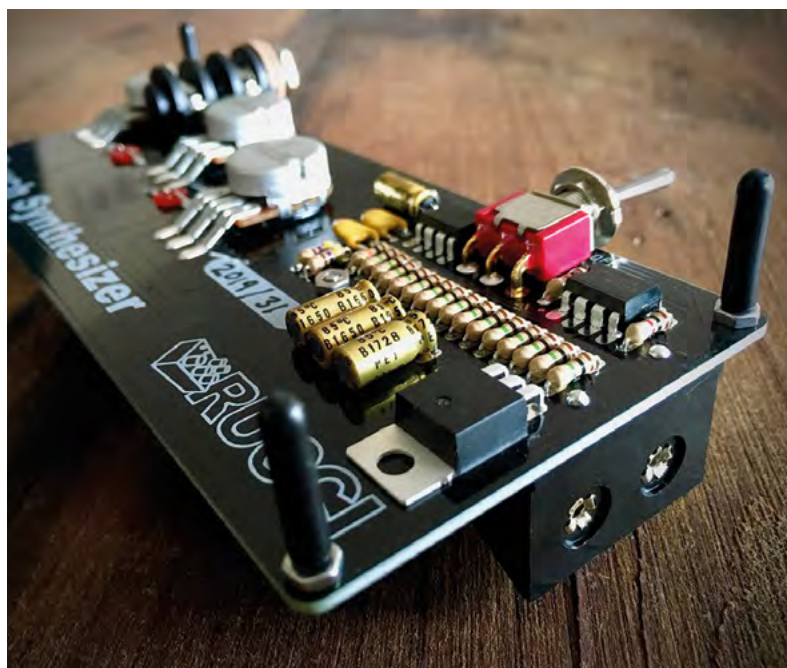

BEST OF BREED

Business Card Synthesizer Kit

DIVISION 6 ◆ \$40 | division-6.com

Division 6 has a lot of great synths and audio gear, but my favourite has to be the **Business Card Synthesizer Kit**. You can connect it to other electronics, or use it by itself by plugging directly into an amp.

Originally designed for a workshop, the kit is now available to everyone.

All the usual configurations are available, including pulse, square, triangle, and saw-tooth waves. There are two LFOs, attack and delay settings, a low-pass filter, sample hold, manual trigger, and tuning controls for fine and coarse adjustments.

And if kits aren't your thing, you can pick up a fully assembled unit too. There's also a good-looking enclosure to keep everything safe and secure. And once again, you have to head online to check out the sounds this diminutively small synth can crank out. □

BUSINESS CARD SEQUENCER KIT

DIVISION 6 ◆ \$35 | division-6.com

If you're interested in the Business Card Synthesizer Kit, you might also want to take a look at the Business Card Sequencer Kit too. It's a similar form factor and will add a whole other dimension to your music-making setup. You can use it as a tiny 16-step sequencer or a keyboard. Check out the site for a full list of features and accessories such as a matching enclosure.

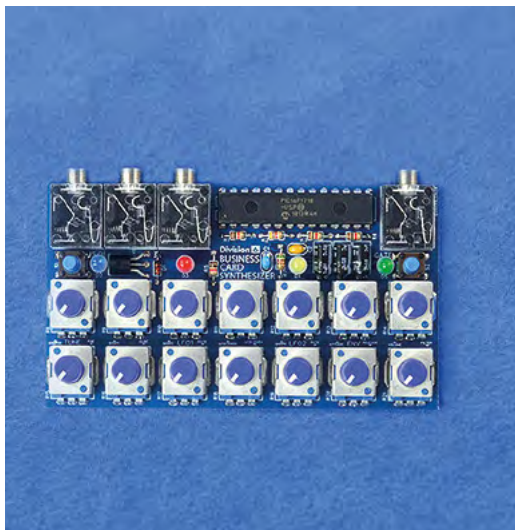
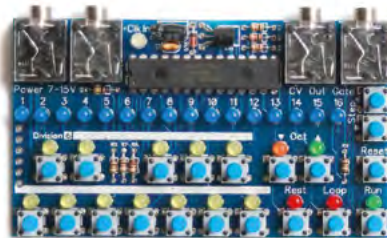

Left ◆
Music on the go

VERDICT

Business Card Synthesizer Kit

Compact can be good!

9/10

GET STARTED

WITH

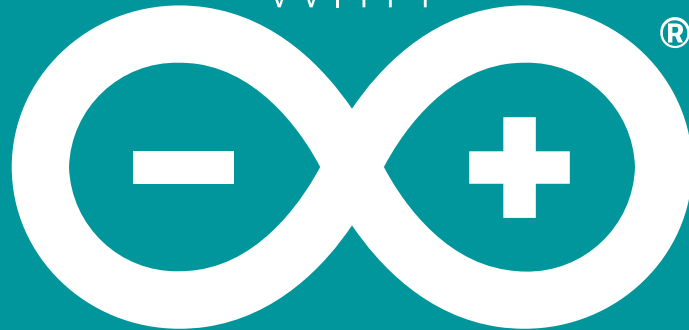

ARDUINO

Robots, musical instruments,
smart displays and more



Inside:

- Build a four-legged walking robot
- Create a Tetris-inspired clock
- Grow veg with hydroponics
- And much more!



AVAILABLE
NOW

hsmag.cc/store

plus all good newsagents and:

WHSmith

BARNES & NOBLE



Available on the
App Store



GET IT ON
Google Play

FROM THE MAKERS OF **HackSpace** MAGAZINE



Portable desktop air compressor

Squashed air, when you're short of space

Below ♦
The small-footprint and lightweight compressor is easy to move around the bench

By Jo Hinchliffe

 @concreted0g



Air compressors are incredibly useful, but are often large, noisy tools that can take up a lot of room in a workshop, or require a lot of plumbing and airlines to site them far away but still be useful.

The benefits of larger compressors are that they can create more pressure and can throughput a larger volume of compressed air, meaning they can power all manner of tools and systems. However, for certain tasks, like scale model airbrushing, or for an air assist on a laser cutter, larger volumes of air aren't particularly needed, and the noise of a larger compressor might be avoided.

In the last few years, tiny desktop air compressors have been available and affordable online, with budget ones sold as 1/5 hp or 1/6 hp compressors. They have a tiny tank and claim to be very quiet in operation. We bought ours for £52 from a generic online platform, and it arrived after a few weeks. Interestingly, ours was advertised as a 1/6 hp model but, when it arrived, the box and the instructions claimed it to be 1/5 hp. We would hazard a guess that a lot of the budget 1/5 or 1/6 hp compressors sold are all the same, regardless of name, and that the motor ratings may not be totally accurate. Whatever the actual rating, it's an important note that these compressors supply enough volume of compressed air for airbrushing, but you could never run any larger air tools off this. You aren't going to be using an air-driven impact wrench with this kit.

Whilst we giggled at the packaging as it states 'Bottom noise' on it as a feature, it arrived well-packed and with a UK plug. Our version was supplied with a relatively useful instruction manual.

At first glance it wasn't too obvious how to adjust the pressure and output of the machine – the adjustment knob has to be lifted before it can be turned. It's a pleasant surprise how well this compressor is built. The only plastic parts are the adjustment knob and the pressure switch housing, and it all feels solidly put-together. The footprint of the compressor is tiny at around 26cm by 15cm, and it truly is a desktop machine.

The compressor is capable of pressurising up to 4 bar and, adjusted to reach this maximum, it will cut out and will power up again once the pressure drops to around 3 bar. Adjusting the output enables you to keep the machine at lower pressures, and it seems to be a similar percentage drop in pressure before the compressor kicks back in to recharge. In use, the pressure switch works well, and the compressor consistently kicks in to maintain the set pressure.

As it has only a tiny tank, it does kick in regularly: you won't get more than a few seconds of supplying any volume of air before it kicks in again. In practice, though, this doesn't really matter as it is very quiet in operation. Certainly, you can work right next to it for a long period without ear protection. If you were using it as an air assist for a laser cutter, it would probably run continuously but, again, we don't think this would add much noise and probably less than the laser cutter extraction system would generate.

It has a ¼" BSP connector which is a common size, meaning that many airbrush kits will be directly

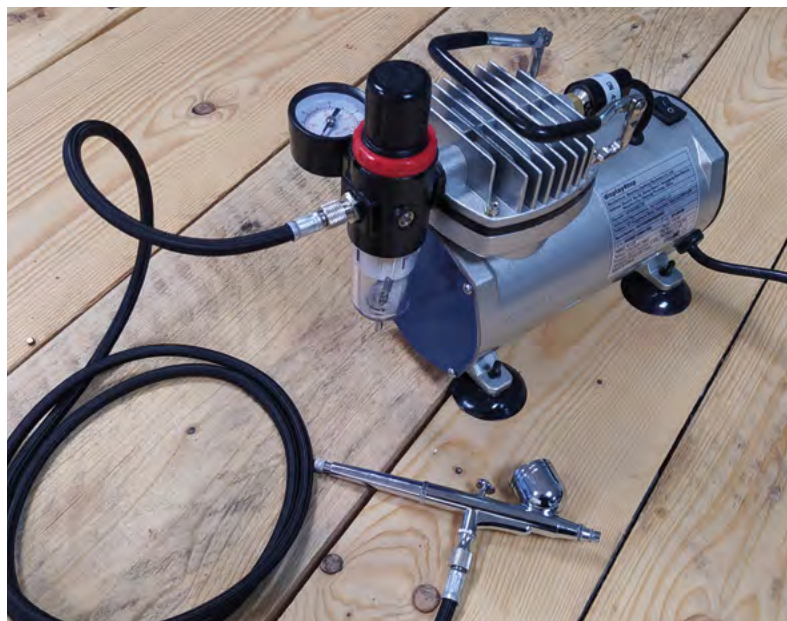

compatible and there are adapters available for ⅛" BSP, for those airbrush kits that require them. Searching online, there are ¼" BSP to hose connectors available to connect to a small pipe for a laser cutter air assist mechanism. It's recommended, with most compressors, to use some PTFE tape on

threaded connectors to stop small leaks, but we found our airbrush hose worked fine without any.

It also has a moisture trap which is useful if using this for airbrush painting. This stops any accumulated moisture

from travelling down the air line, which would cause problems with paint finishes. The compressor is oilless (unlike its larger contemporaries), so we have found that for airbrush work it's a very clean air supply. Being tiny, it's also very light, at around 3.5 kg, and has a pretty robust carrying handle which can be folded out of the way. After trying airbrushing with a larger compressor, it's certainly much easier to be able to site the compressor and air lines in places, making it easy to work with.

The only small issue we have found with the compressor is that it sits on rubber sucker-type feet, and these were variable on different surfaces in terms of how well they stuck down or held the compressor in place. On a kitchen worktop-type surface, we found the compressor could slowly travel with the vibration. This is easily rectified with a small clamp, or other ways to keep it in place. Overall, we are finding this a really useful little compressor for our airbrushing experiments. □

Above ♦ All set up with a budget airbrush; this compressor can help create a reasonable budget setup

Left ▣ Whilst we did giggle at the text on the packaging, the unit is very quiet in operation

Overall, we are finding this a really useful little compressor for our airbrushing experiments

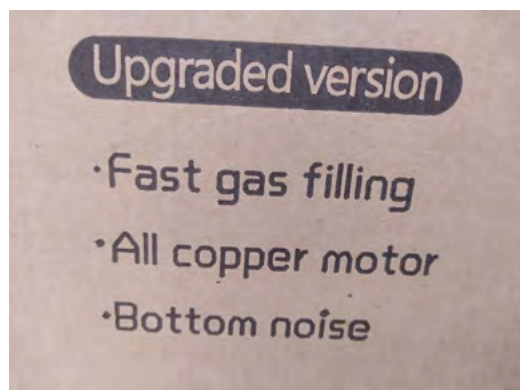

QT Py

A small package with a lot of connection options

ADAFRUIT  \$6 | adafruit.com

By Ben Everard

 @ben_everard

The QT Py is a tiny microcontroller board from Adafruit. It packs an impressive amount of connection options into a small footprint. There is SPI, I2C, UART, I2S, eleven digital I/O, nine analogue inputs, one true analogue output, nine PWM outputs, six capacitive touch inputs, and one on-board NeoPixel. Given the name, it should come as no surprise that there's also an I2C connection in a STEMMA QT adapter, so you can plug any STEMMA QT or Qwiic devices straight in. In other words, this can communicate with almost anything.

Below  The extra flash memory chip is very useful when running CircuitPython



Other than the connectivity, there's very little on the board other than a USB port and associated gubbins, so the features of the QT Py are basically the features of the SAMD21 microcontroller that drives it. There's an ARM Cortex-M0+ processor running at 48MHz, 256kB of flash, and 32kB of RAM. You can program it using either CircuitPython or Arduino. Using CircuitPython, the biggest limitation is the flash memory. CircuitPython itself takes up over 200 of the 256kB of flash, leaving you 48kB for your code, data, and any modules you want to import. Simple modules that just communicate with a sensor or drive an actuator are typically only 1kB or 2kB, so this isn't too bad. However, anything that requires fonts, sounds, or images may struggle without the extra flash memory chip.

One thing it's missing is any form of mounting hole. The flat bottom may be easy to stick down with glue, and you could also solder it down to a PCB. However, it's no longer a flat bottom if you add a flash chip to it. A blob of hot glue should do the job if you need to keep it stationary.

The SAMD21 is kind of a transitional chip. If you are working in the Arduino environment, it's got buckets of power and – unless you're really trying to push the limits with things like machine learning – you're unlikely to be limited by either storage or processing speed. CircuitPython, on the other hand, is a different story. The SAMD21 is basically the entry-level CircuitPython microcontroller. It can run CircuitPython reliably, but it is limited by both speed and storage. Provided your code doesn't need to handle lots of data quickly, you should be OK. However, unless your code is very simple and needs very few libraries, you will probably want to add the extra 2MB flash.

There are a surprising number of projects that don't require a huge amount from a microcontroller

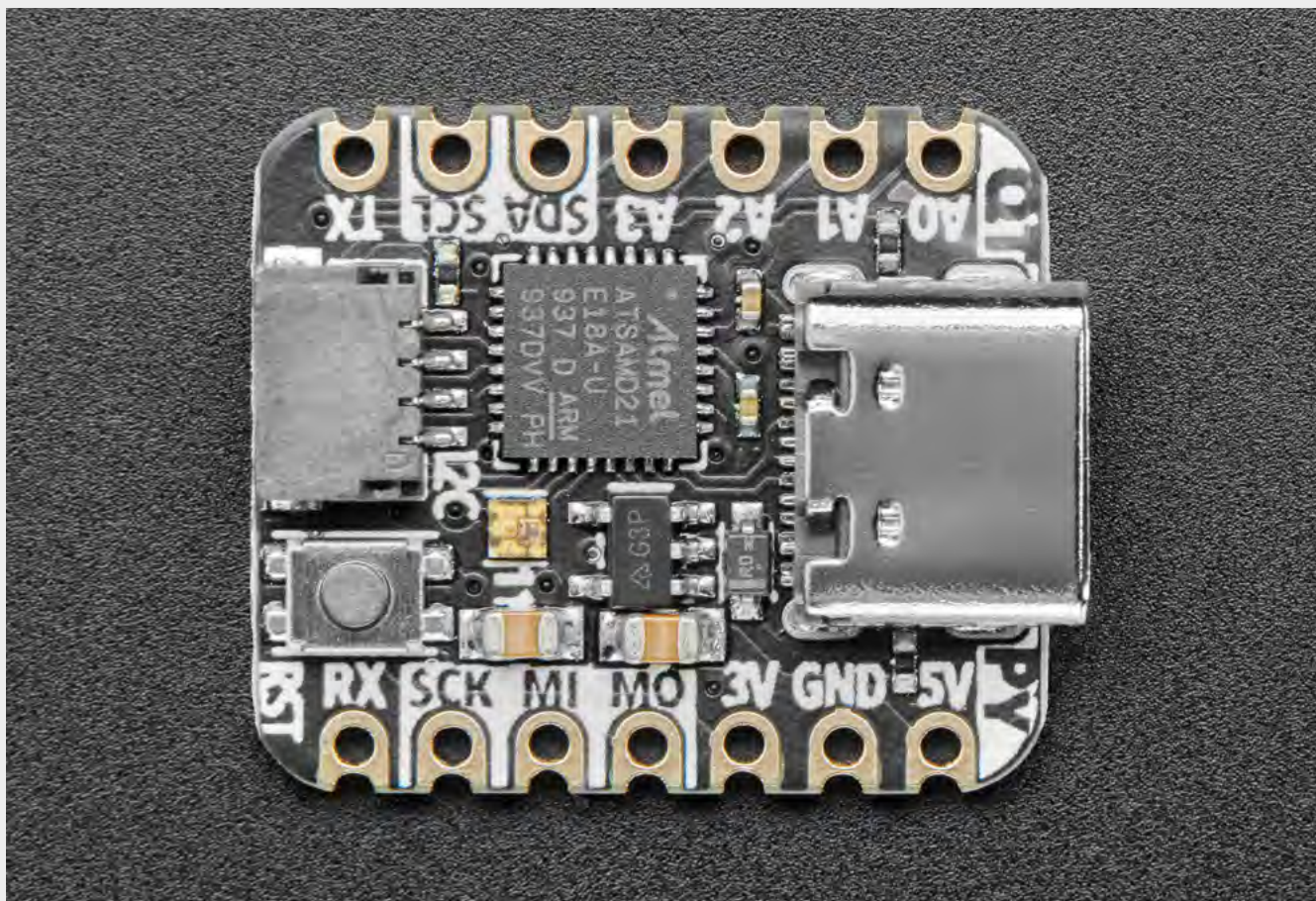

– either in terms of power or number of pins. Maybe you’re connecting a sensor with an actuator so that when a certain event happens, it triggers a particular movement. Perhaps it’s just because the USB port takes up a large proportion of this board, but we can

“ The QT Py is a microcontroller stripped down and squeezed into a tiny package ”

see the QT Py being useful for connecting peripherals to a computer. This could mean getting data from a sensor into your computer through USB serial, or using the USB serial connection to trigger something to happen. The Qwiic-compatible STEMMA QT connector means that developing the hardware side of things can be really easy.

At the current price of \$6, this makes these little devices a much more attractive proposition for those little projects that you might not want to dedicate a £20 board to. Do you want an LED that lights up red when your software test fails, and green when it passes? It’s yours for \$6 (plus a bit of time coding). Do you want a big tinfoil hand that you can high-five to send a magazine to the printers? Yours for \$6 (plus a bit of time coding). OK, that last one might just be us, but hopefully you get the idea.

The QT Py is a microcontroller stripped down and squeezed into a tiny package. It’s not going to set any performance records, but it does open up some possibilities for projects that either don’t have the space for a larger microcontroller board, or need to be done on a tight budget. We’ve seen small microcontrollers before. We’ve seen cheap microcontrollers before. We’ve seen microcontrollers with a wide range of communication options before. However, the QT Py is the first we’ve seen to marry all these things together in an easy-to-use package. □

Above ♦ There’s so much packed onto such a small PCB

VERDICT

A huge potential in a small package.

9/10

MicroMod

Flexible microcontrollers through modular design

SPARKFUN  from \$14.95 | sparkfun.com

By Ben Everard

 @ben_everard

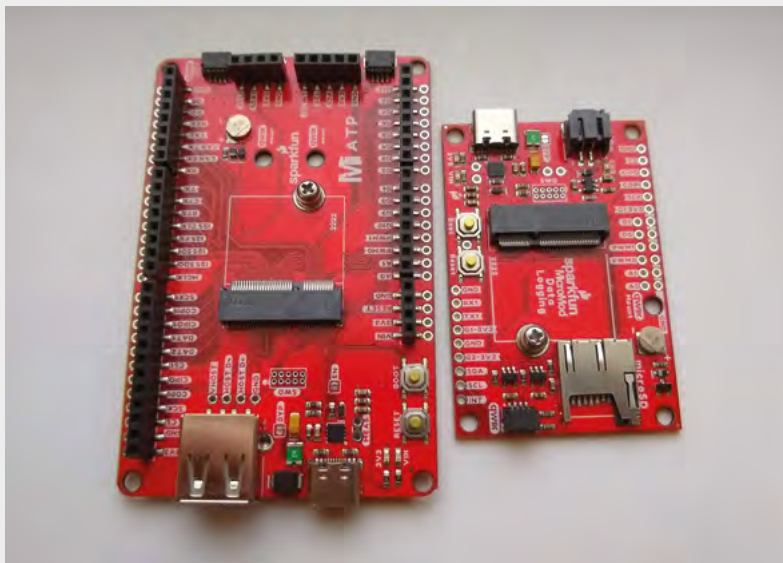

Above  The All The Pins (ATP) and Data Logger carrier boards

The MicroMod system from SparkFun isn't so much a set of new products, as a new concept for microcontroller boards. It's a range of processor boards with M.2 edge connectors and carrier boards that these can slot into.

This gives you a mix-and-match approach to building your control board.

Reviewing the MicroMod system has proved surprisingly hard. Not because the technology behind it is difficult to use – it slots together easily and can be programmed using the Arduino IDE – but because the idea is actually quietly revolutionary in its own way.

For over a decade, hobbyist electronics projects systems have worked in one of two ways: either you start with a base board like an Arduino Uno or Raspberry Pi computer, and then slot on top a

compatible add-on; or, you have two separate PCBs with separate connectors that you wire together yourself. There are a few options to simplify this latter option – such as Qwiic – but those, fundamentally, have been your two options.

MicroMod changes this. It's different in that the microcontroller is on a very stripped-down board with a standard connector that slots into a carrier board. Carrier boards are a bit like shields or HATs in that they add on extra functionality and breakout features, but they're different in a few ways. The connection is much more compact – the processor board is barely higher than the USB port. The processor boards are secured tightly to the carrier boards with both an M.2 slot and a screw. This should be reliable for long-term use. The carrier boards are typically much larger than the processor board, and there's no standard size and shape, so designers can use whatever form factor makes sense for their particular design.

You can't stack carrier boards as there's no standard pinout, but the currently available carrier boards break out some pins and have Qwiic connectors for extra hardware.

At the time of writing, there are four carrier boards:

- ATP, which is a roughly Arduino Uno-shaped board that breaks out all of the pins
- Input and Display board, which has a 2.4-inch 240x320 pixel display, magnetic buzzer, six addressable APA102 RGB LEDs, a micro joystick, and two user buttons
- Machine Learning, which has a camera connector and a three-axis accelerometer
- Data Logging, which includes LiPo battery charger, microSD card, and a lot of pins broken out

Into these, you can plug one of three processor boards:

- SAMD51 – an ARM-M4 processor running up to 120MHz
- Artemis – an energy-efficient ARM-M4 processor running up to 64MHz with on-board Bluetooth
- ESP32 – a dual-core Tensilica processor running up to 240MHz with on-board Bluetooth and WiFi

Of course, this is just the current selection – we anticipate that more will be available over time. However, you're not limited to just the available boards – you can create your own. If you've got a processor that you're particularly eager to play with, or want to tidy up your project into a final board, MicroMod could help you do it. There's a guide to what to do at hsmag.cc/micromod, and Eagle files for the SparkFun products are on their GitHub.

We've had a lot of fun playing with the MicroMod kit. There's been a few teething problems with bits of software not quite working as expected initially, but with a new release featuring a lot of combinations of hardware, that's not surprising – we're sure they'll be sorted out in time. However, there's a bit of a difference between playing with review hardware and parting with your own money, and the fact is MicroMod can be an expensive option. All of the MicroMod boards are \$14.95, and the carrier boards vary from \$19.95 to \$59.95 (for Input and Display). To put it into context: a single-board solution – the Artemis ATP from SparkFun is \$24.95, while the Artemis MicroMod processor board plus an ATP carrier board is \$34.90. That's quite a lot more money, but it's also not quite the point. If a single board exists that does everything you need, it will almost always be smaller and cheaper. Things like MicroMod (and, for that matter, Arduino shields) exist for when there's not a single board that does everything you need. SparkFun doesn't do large boards for SAMD51 or ESP32, but with MicroMod, they become possible. Similarly, if you need a large board with different processors, getting one ATP carrier board and all three processor boards allows you to pick the right combination for each project without the expense of large boards for each. In practice, whether or not MicroMod proves to be expensive or cheap depends a lot on how you use development boards.

“ You're not limited to just the available boards – you can create your own ”



It may be that, in the future, MicroMod has the biggest effect on niche areas of electronics. For example, there are some interesting microcontroller boards designed for wearables with sewable IO headers, but the range is limited. A sewable carrier board would then let you select from a range of microcontrollers that aren't currently available in a wearable form factor. The same applies to niche processor boards. For example, if someone developed an FPGA MicroMod board, they'd instantly have access to more form factors than almost any other FPGA board.

There's a lot to unpack about MicroMod and how it relates to hobby electronics. It can be small and compact. It can be flexible. It can be secure. In some cases, it may be production-ready. It may be a good base for building custom boards for your project off. However, it can also be expensive. Ultimately, like all ecosystems, it will live or die depending on the range it grows into. At the moment, there are a few interesting options, but for it to become a useful platform, there needs to be more than a few. It wouldn't take many more options, though, to make this a really exciting ecosystem, particularly for projects where space is at a premium. □

Above ♦
The three processor boards available now

VERDICT

A deceptively simple idea that may make your projects smaller and more flexible in the future.

9/10

next month

ISSUE
#39

ON SALE
21 JANUARY

BUDGET BUILDS

ALSO

- * PERFECT YOUR MICROCONTROLLER PROGRAMMING
- * INTELLIGENT MACHINE LEARNING
- * COMPLETE BEGINNER'S GUIDE TO MICROPYTHON
- * OPTIMISE YOUR RASPBERRY PI
- * AND MUCH MORE

DON'T MISS OUT

hsmag.cc/subscribe

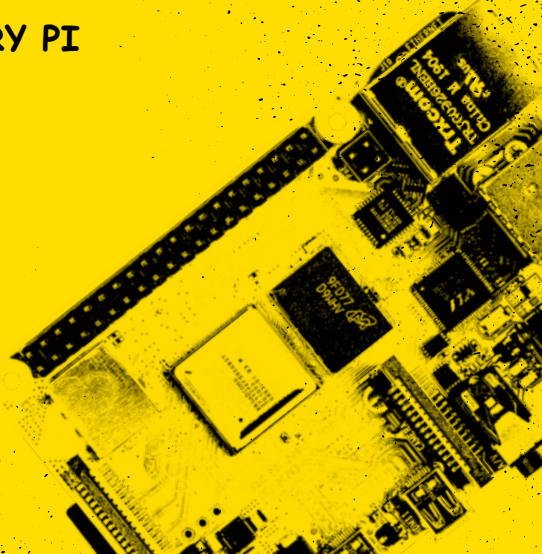



When we think about input devices, we usually think of buttons, knobs, and maybe touchscreens. However, you can be more inventive. With resistive and capacitive touch sensing, you can turn almost anything conductive into an input device. This could be a metal bolt, a button sewn onto your jacket, or even a pair of jellies.

<https://pimoroni.com>

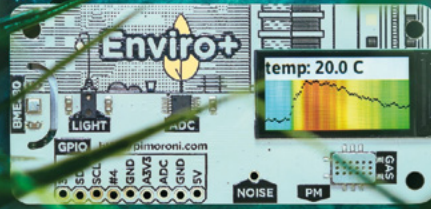

Enviro+ HAT Mini

better living through geekery

Pirate Audio Dual Mic



PIMORONI

Breakout Garden for Pi 400

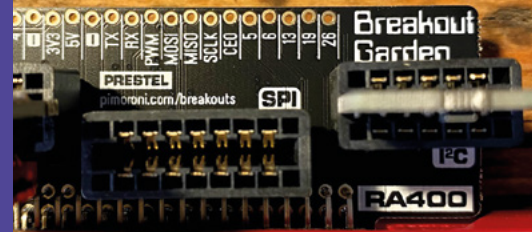

Picade 10" - New Edition



thousands of products homemade & best of the makerverse

Grow HAT Mini

